

NJL3281D (NPN) NJL1302D (PNP)

Complementary ThermalTrak™ Transistors

The ThermalTrak family of devices has been designed to eliminate thermal equilibrium lag time and bias trimming in audio amplifier applications. They can also be used in other applications as transistor die protection devices.

Features

- Thermally Matched Bias Diode
- Instant Thermal Bias Tracking
- Absolute Thermal Integrity
- High Safe Operating Area
- Pb-Free Packages are Available*

Benefits

- Eliminates Thermal Equilibrium Lag Time and Bias Trimming
- Superior Sound Quality Through Improved Dynamic Temperature Response
- Significantly Improved Bias Stability
- Simplified Assembly
 - ◆ Reduced Labor Costs
 - ◆ Reduced Component Count
- High Reliability

Applications

- High-End Consumer Audio Products
 - ◆ Home Amplifiers
 - ◆ Home Receivers
- Professional Audio Amplifiers
 - ◆ Theater and Stadium Sound Systems
 - ◆ Public Address Systems (PAs)



ON Semiconductor®

<http://onsemi.com>

**BIPOLAR POWER
TRANSISTORS**
15 AMP, 260 VOLT, 200 WATT

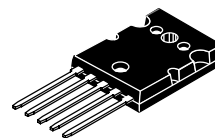

TO-264, 5 LEAD
CASE 340AA
STYLE 1

MARKING DIAGRAM

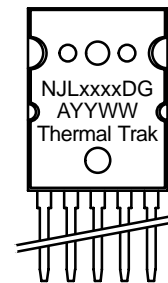

SCHEMATIC

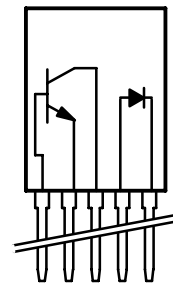

NJLxxxxD = Device Code
 xxxx = 3281 or 1302
 G = Pb-Free Package
 A = Assembly Location
 YY = Year
 WW = Work Week

ORDERING INFORMATION

| Device | Package | Shipping |
|-----------|---------------------|-----------------|
| NJL3281D | TO-264 | 25 Units / Rail |
| NJL3281DG | TO-264 (Pb-Free) | 25 Units / Rail |
| NJL1302D | TO-264 | 25 Units / Rail |
| NJL1302DG | TO-264 (Pb-Free) | 25 Units / Rail |

*For additional information on our Pb-Free strategy and soldering details, please download the ON Semiconductor Soldering and Mounting Techniques Reference Manual, SOLDERRM/D.

NJL3281D (NPN) NJL1302D (PNP)

MAXIMUM RATINGS (T_J = 25°C unless otherwise noted)

| Rating | Symbol | Value | Unit |
|--|-----------------------------------|--------------|-----------|
| Collector–Emitter Voltage | V _{CEO} | 260 | Vdc |
| Collector–Base Voltage | V _{CBO} | 260 | Vdc |
| Emitter–Base Voltage | V _{EBO} | 5 | Vdc |
| Collector–Emitter Voltage – 1.5 V | V _{CEX} | 260 | Vdc |
| Collector Current – Continuous – Peak (Note 1) | I _C | 15 25 | Adc |
| Base Current – Continuous | I _B | 1.5 | Adc |
| Total Power Dissipation @ T _C = 25°C Derate Above 25°C | P _D | 200 1.43 | W W/°C |
| Operating and Storage Junction Temperature Range | T _J , T _{stg} | – 65 to +150 | °C |
| DC Blocking Voltage | V _R | 200 | V |
| Average Rectified Forward Current | I _{F(AV)} | 1.0 | A |

THERMAL CHARACTERISTICS

| Characteristic | Symbol | Max | Unit |
|--------------------------------------|------------------|-------|------|
| Thermal Resistance, Junction–to–Case | R _{θJC} | 0.625 | °C/W |

Stresses exceeding Maximum Ratings may damage the device. Maximum Ratings are stress ratings only. Functional operation above the Recommended Operating Conditions is not implied. Extended exposure to stresses above the Recommended Operating Conditions may affect device reliability.

1. Pulse Test: Pulse Width = 5 ms, Duty Cycle < 10%.

ATTRIBUTES

| Characteristic | Value |
|---|----------------------|
| ESD Protection Human Body Model Machine Model | >8000 V > 400 V |
| Flammability Rating | UL 94 V–0 @ 0.125 in |

NJL3281D (NPN) NJL1302D (PNP)

ELECTRICAL CHARACTERISTICS ($T_C = 25^\circ\text{C}$ unless otherwise noted)

| Characteristic | Symbol | Min | Max | Unit |
|--|----------------|----------------------------|-------------------------------|-----------------|
| OFF CHARACTERISTICS | | | | |
| Collector-Emitter Sustaining Voltage ($I_C = 100\text{ mAdc}$, $I_B = 0$) | $V_{CEO(sus)}$ | 260 | – | Vdc |
| Collector Cutoff Current ($V_{CB} = 260\text{ Vdc}$, $I_E = 0$) | I_{CBO} | – | 50 | μAdc |
| Emitter Cutoff Current ($V_{EB} = 5\text{ Vdc}$, $I_C = 0$) | I_{EBO} | – | 5 | μAdc |
| ON CHARACTERISTICS | | | | |
| DC Current Gain ($I_C = 500\text{ mAdc}$, $V_{CE} = 5\text{ Vdc}$) ($I_C = 1\text{ Adc}$, $V_{CE} = 5\text{ Vdc}$) ($I_C = 3\text{ Adc}$, $V_{CE} = 5\text{ Vdc}$) ($I_C = 5\text{ Adc}$, $V_{CE} = 5\text{ Vdc}$) ($I_C = 8\text{ Adc}$, $V_{CE} = 5\text{ Vdc}$) | h_{FE} | 75 75 75 75 45 | 150 150 150 150 – | |
| Collector-Emitter Saturation Voltage ($I_C = 10\text{ Adc}$, $I_B = 1\text{ Adc}$) | $V_{CE(sat)}$ | – | 3 | Vdc |
| DYNAMIC CHARACTERISTICS | | | | |
| Current-Gain – Bandwidth Product ($I_C = 1\text{ Adc}$, $V_{CE} = 5\text{ Vdc}$, $f_{test} = 1\text{ MHz}$) | f_T | 30 | – | MHz |
| Output Capacitance ($V_{CB} = 10\text{ Vdc}$, $I_E = 0$, $f_{test} = 1\text{ MHz}$) | C_{ob} | – | 600 | pF |
| Maximum Instantaneous Forward Voltage (Note 2) ($i_F = 1.0\text{ A}$, $T_J = 25^\circ\text{C}$) ($i_F = 1.0\text{ A}$, $T_J = 150^\circ\text{C}$) | V_F | | 1.1 0.93 | V |
| Maximum Instantaneous Reverse Current (Note 2) (Rated dc Voltage, $T_J = 25^\circ\text{C}$) (Rated dc Voltage, $T_J = 150^\circ\text{C}$) | i_R | | 10 100 | μA |
| Maximum Reverse Recovery Time ($i_F = 1.0\text{ A}$, $di/dt = 50\text{ A}/\mu\text{s}$) | t_{rr} | | 100 | ns |

2. Diode Pulse Test: Pulse Width = 300 μs , Duty Cycle $\leq 2.0\%$.

NJL3281D (NPN) NJL1302D (PNP)

TYPICAL CHARACTERISTICS

PNP NJL1302D

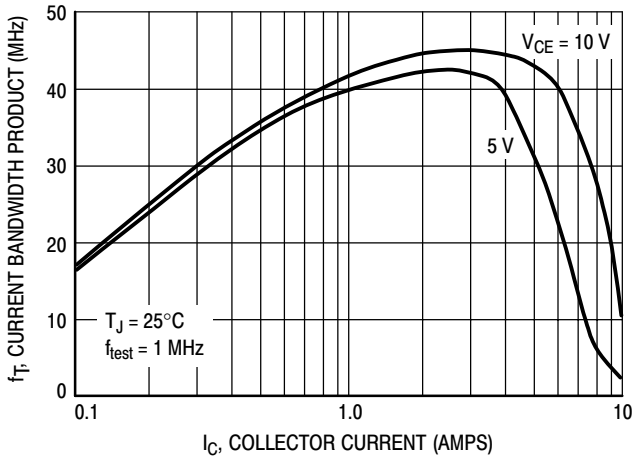

Figure 1. Typical Current Gain Bandwidth Product

NPN NJL3281D

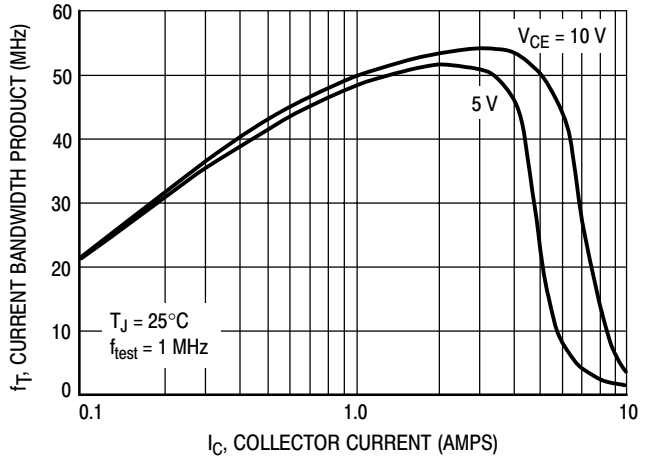

Figure 2. Typical Current Gain Bandwidth Product

PNP NJL1302D

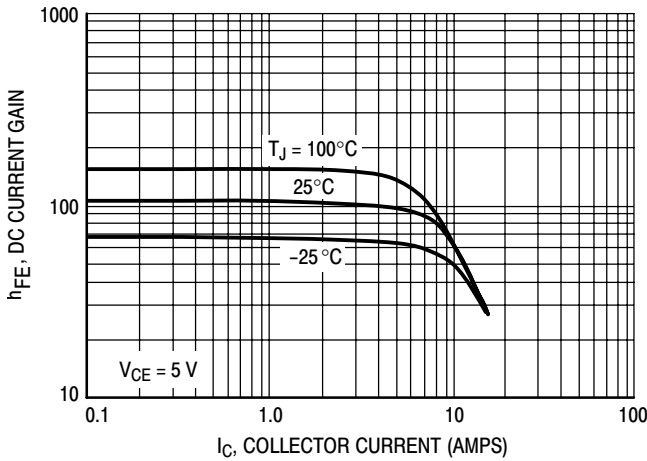

Figure 3. DC Current Gain, $V_{CE} = 5V$

NPN NJL3281D

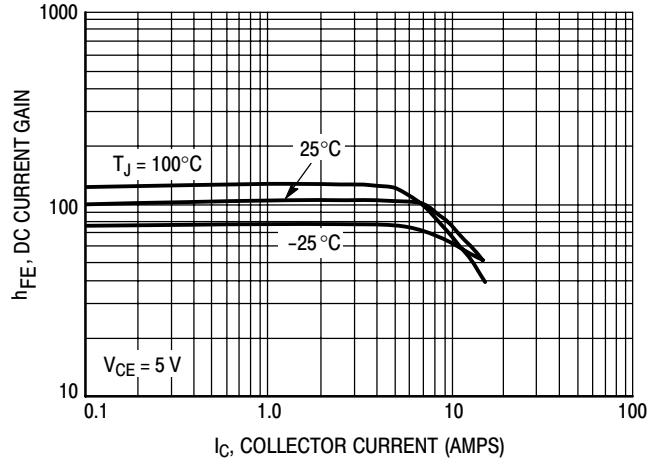

Figure 4. DC Current Gain, $V_{CE} = 5V$

PNP NJL1302D

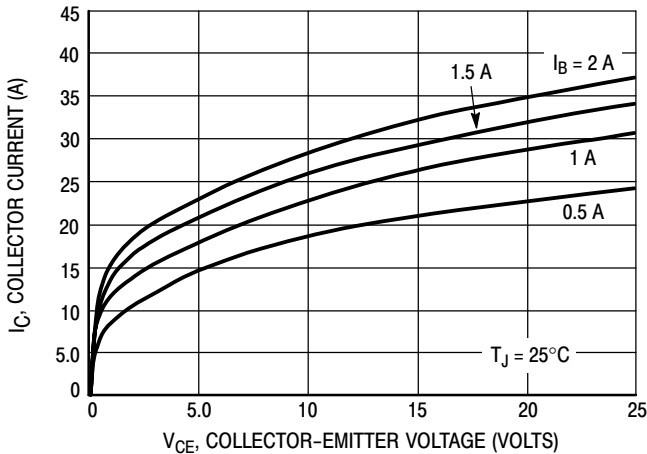

Figure 5. Typical Output Characteristics

NPN NJL3281D

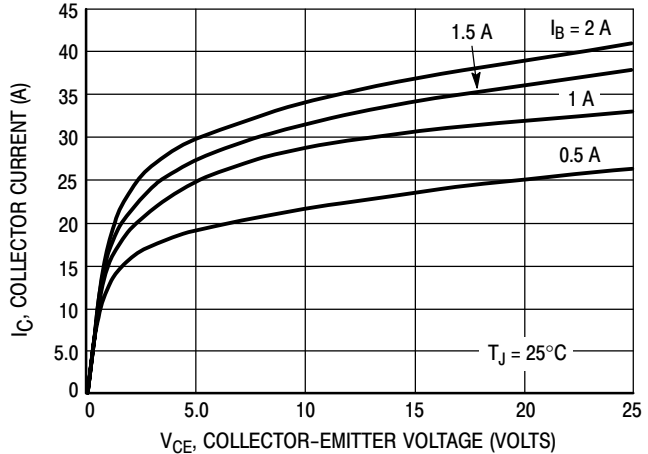

Figure 6. Typical Output Characteristics

NJL3281D (NPN) NJL1302D (PNP)

TYPICAL CHARACTERISTICS

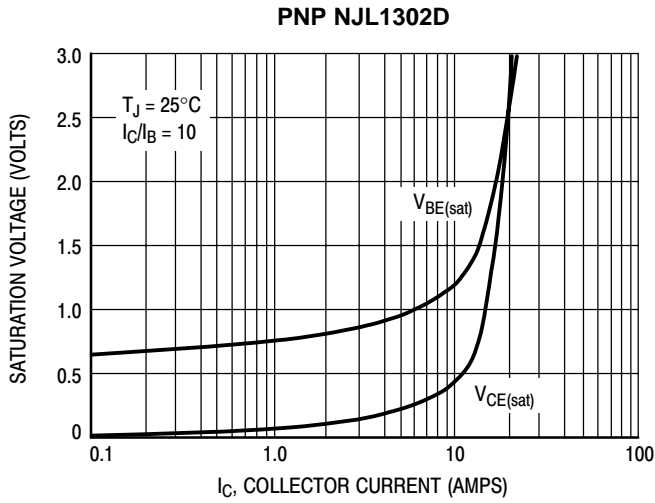

Figure 7. Typical Saturation Voltages

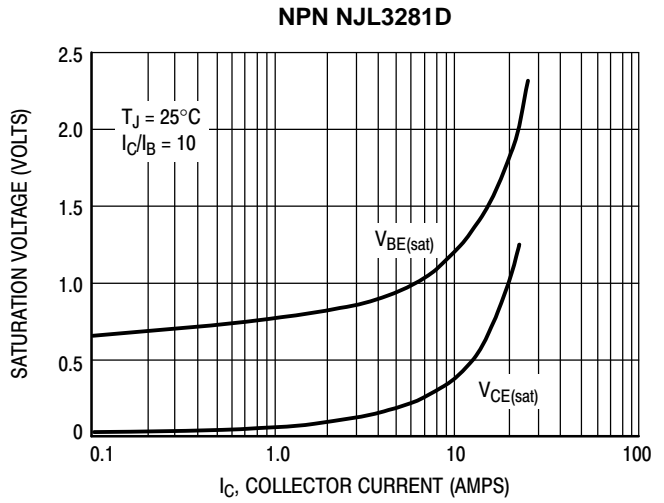

Figure 8. Typical Saturation Voltages

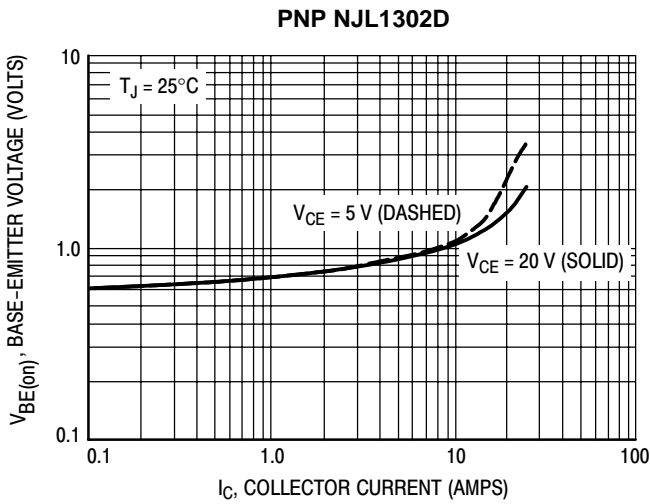

Figure 9. Typical Base-Emitter Voltage

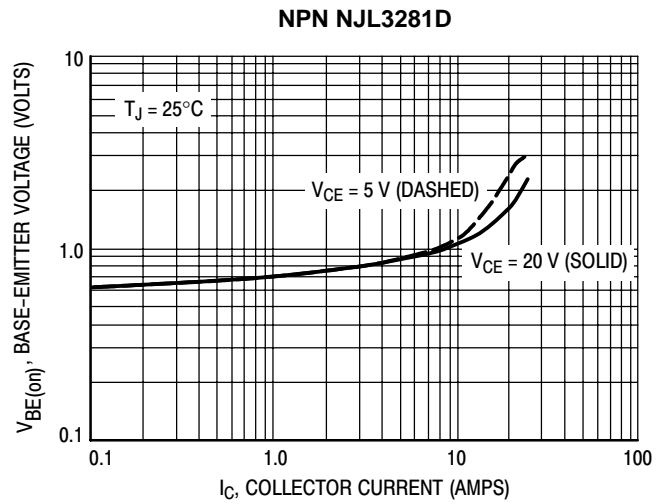

Figure 10. Typical Base-Emitter Voltage

NJL3281D (NPN) NJL1302D (PNP)

TYPICAL CHARACTERISTICS

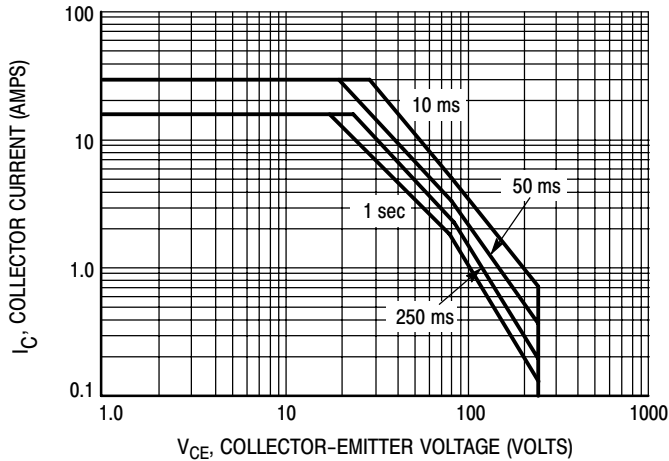

Figure 11. Active Region Safe Operating Area

There are two limitations on the power handling ability of a transistor; average junction temperature and secondary breakdown. Safe operating area curves indicate $I_C - V_{CE}$ limits of the transistor that must be observed for reliable operation; i.e., the transistor must not be subjected to greater dissipation than the curves indicate.

The data of Figure 11 is based on $T_{J(pk)} = 150^\circ\text{C}$; T_C is variable depending on conditions. At high case temperatures, thermal limitations will reduce the power than can be handled to values less than the limitations imposed by second breakdown.

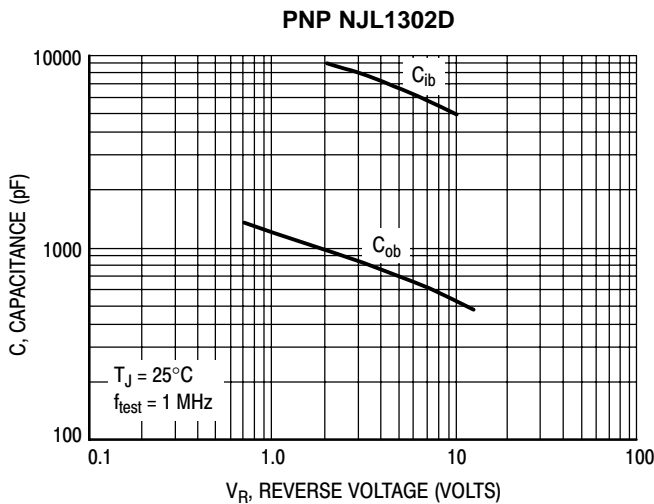

Figure 12. NJL1302D Typical Capacitance

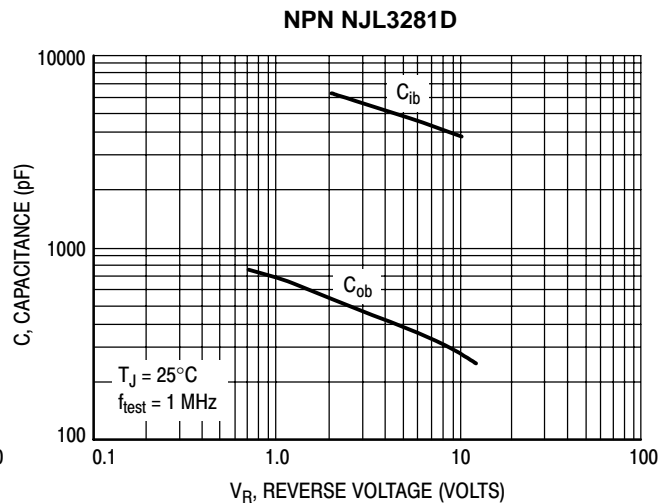

Figure 13. NJL3281D Typical Capacitance

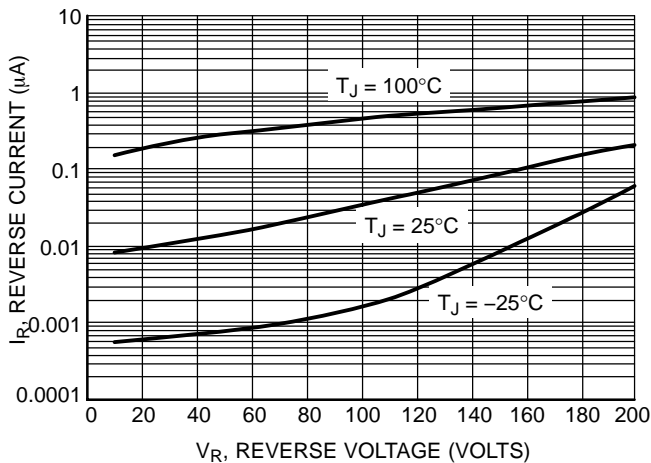

Figure 14. Typical Reverse Current

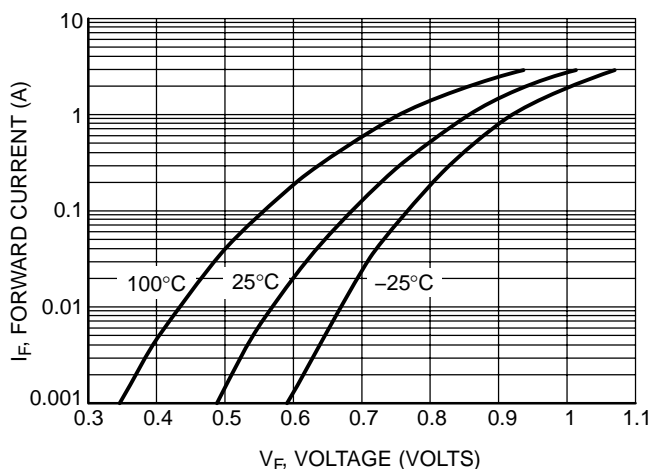
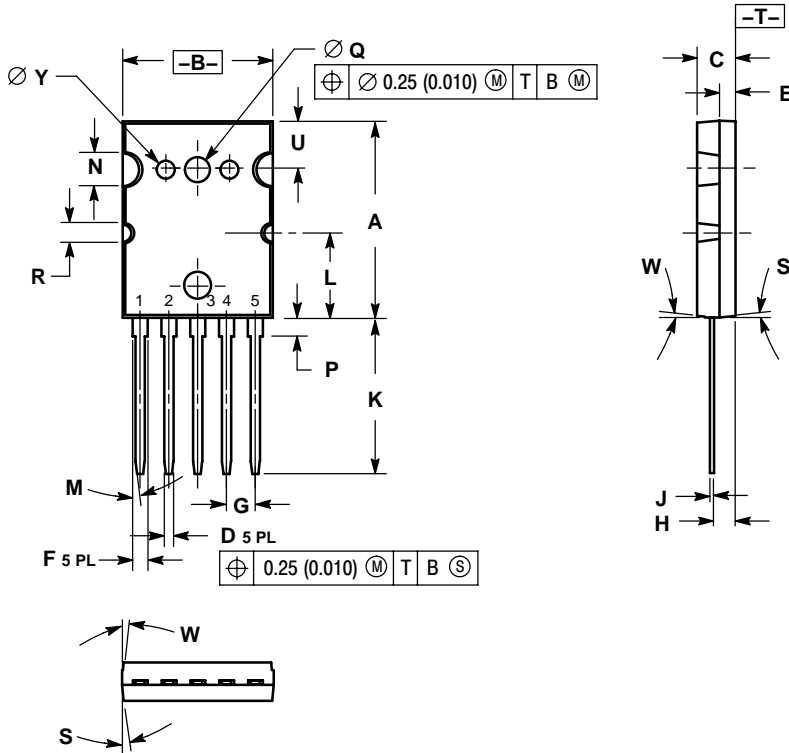

Figure 15. Typical Forward Voltage

NJL3281D (NPN) NJL1302D (PNP)

PACKAGE DIMENSIONS

TO-264, 5 LEAD
CASE 340AA-01
ISSUE O



NOTES:

1. DIMENSIONING AND TOLERANCING PER ANSI Y14.5M, 1982.
2. CONTROLLING DIMENSION: MILLIMETER.

| DIM | MILLIMETERS | | | INCHES | | |
|-----|-------------|--------|--------|------------|--------|--------|
| | MIN | NOM | MAX | MIN | NOM | MAX |
| A | 25.857 | 25.984 | 26.111 | 1.018 | 1.023 | 1.028 |
| B | 19.761 | 19.888 | 20.015 | 0.778 | 0.783 | 0.788 |
| C | 4.928 | 5.055 | 5.182 | 0.194 | 0.199 | 0.204 |
| D | 1.219 BSC | | | 0.0480 BSC | | |
| E | 2.032 | 2.108 | 2.184 | 0.0800 | 0.0830 | 0.0860 |
| F | 1.981 BSC | | | 0.0780 BSC | | |
| G | 3.81 BSC | | | 0.150 BSC | | |
| H | 2.667 | 2.718 | 2.769 | 0.1050 | 0.1070 | 0.1090 |
| J | 0.584 BSC | | | 0.0230 BSC | | |
| K | 20.422 | 20.549 | 20.676 | 0.804 | 0.809 | 0.814 |
| L | 11.28 REF | | | 0.444 REF | | |
| M | 0° | --- | 7° | 0° | --- | 7° |
| N | 4.57 REF | | | 0.180 REF | | |
| P | 2.259 | 2.386 | 2.513 | 0.0889 | 0.0939 | 0.0989 |
| Q | 3.480 BSC | | | 0.1370 BSC | | |
| R | 2.54 REF | | | 0.100 REF | | |
| S | 0° | --- | 8° | 0° | --- | 8° |
| U | 6.17 REF | | | 0.243 REF | | |
| W | 0° | --- | 6° | 0° | --- | 6° |
| Y | 2.388 BSC | | | 0.0940 BSC | | |

STYLE 1:

1. BASE
2. EMITTER
3. COLLECTOR
4. ANODE
5. CATHODE

ThermalTrak is a trademark of Semiconductor Components Industries, LLC (SCILLC).

ON Semiconductor and are registered trademarks of Semiconductor Components Industries, LLC (SCILLC). SCILLC reserves the right to make changes without further notice to any products herein. SCILLC makes no warranty, representation or guarantee regarding the suitability of its products for any particular purpose, nor does SCILLC assume any liability arising out of the application or use of any product or circuit, and specifically disclaims any and all liability, including without limitation special, consequential or incidental damages. "Typical" parameters which may be provided in SCILLC data sheets and/or specifications can and do vary in different applications and actual performance may vary over time. All operating parameters, including "Typicals" must be validated for each customer application by customer's technical experts. SCILLC does not convey any license under its patent rights nor the rights of others. SCILLC products are not designed, intended, or authorized for use as components in systems intended for surgical implant into the body, or other applications intended to support or sustain life, or for any other application in which the failure of the SCILLC product could create a situation where personal injury or death may occur. Should Buyer purchase or use SCILLC products for any such unintended or unauthorized application, Buyer shall indemnify and hold SCILLC and its officers, employees, subsidiaries, affiliates, and distributors harmless against all claims, costs, damages, and expenses, and reasonable attorney fees arising out of, directly or indirectly, any claim of personal injury or death associated with such unintended or unauthorized use, even if such claim alleges that SCILLC was negligent regarding the design or manufacture of the part. SCILLC is an Equal Opportunity/Affirmative Action Employer. This literature is subject to all applicable copyright laws and is not for resale in any manner.

PUBLICATION ORDERING INFORMATION

LITERATURE FULFILLMENT:

Literature Distribution Center for ON Semiconductor
P.O. Box 5163, Denver, Colorado 80217 USA
Phone: 303-675-2175 or 800-344-3860 Toll Free USA/Canada
Fax: 303-675-2176 or 800-344-3867 Toll Free USA/Canada
Email: orderlit@onsemi.com

N. American Technical Support: 800-282-9855 Toll Free
USA/Canada
Europe, Middle East and Africa Technical Support:
Phone: 421 33 790 2910
Japan Customer Focus Center
Phone: 81-3-5773-3850

ON Semiconductor Website: www.onsemi.com

Order Literature: <http://www.onsemi.com/orderlit>

For additional information, please contact your local Sales Representative

NJL3281D/D