

IP POWER 9258 USER MANUAL



USER MANUAL



IP POWER 9258
Version: X.X
2005.11

Warning:

Any changes to this equipment without permission may cause damages to your equipment! This equipment has been proved by CE & FCC to can be prevented from the influence of harmful electronic jamming in normal business use condition.

IMPORTANT NOTICE

1. We have no responsibility for the possible damage caused by improper usage or abnormal working environment.
2. Do not use I POWER 9258 in strong shaking condition.
3. Please contact the dealer If I POWER works improperly.

Copyright © 2005 Aviosys. All rights reserved. No part of this publication may be reproduced, stored in a retrieval system, or transmitted in any form or by any means, electronic, mechanical, photocopying, recording or otherwise, without the prior written consent of Aviosys

All other products mentioned in this document are trademarks of their respective manufactures.

AVIOSYS are exempt from notify any change of our products.

Table of Content

1. INTRODUCTION.....	4
FEATURES	4
9258 FUNCTION DESCRIBE	4
2.SPECIFICATION.....	5
PACKAGE CONTENTS	5
MINIMUM SYSTEM REQUIREMENTS	5
3.INTERFACE DESCRIPTION	6
4.HARDWARE & SOFTWARE INSTALLATION.....	7
HARDWARE INSTALLATION	7
SOFTWARE INSTALLATION.....	7
5. INITIAL SETTING	8
INITIAL SETTING THROUGH ETHERNET	8
READ MESSAGE FROM RS232 SERIAL-PORT	9
6. CONTROL AND SETTING THROUTH THE INTERNET EXPLORE.....	10
LOGIN.....	10
CONTROL THE POWER SUPPLY OF OUTLETS.....	10
POWER SUPPLY STATE QUERY.....	10
SYSTEM SETTING	11
SETTING THE PASSWORD.....	
SETTING THE IP ADDRESS.....	
EMAIL SETTINGS.....	
SETTING THE TIME SCHEDULE.....	
ONLINE FIRMWARE UPDATE.....	
INTERNAL CLOCK SETTINGS.....	
7. CHECK STATUS THROUGH SNMP	16
8. CONTROL AND SETTINGS THROUGH HTTP ORDER.....	17
ORDER FORMAT.....	17

1. Introduction

IP POWER 9258 is a web controller which can be easily used in the industry field. With the remote network control technology, user can control or query the power supply of equipment.

User can do this in any computer connected to the internet or local area network, there is no special program needed, also there is no need to open the external case of the computer. Try to imagine that while traveling in a foreign country, you can control the power supply of your electric equipments, such as a computer, a server, a router, an entrance guard or security / surveillance system directly or use a time schedule comes with the IP POWER 9258. You can remotely control the power switch with any computer connected to the network, which is not only convenient, but it also big saving on the manpower and time.

Feature:

1. Built in web server, can be used through the Ethernet network or Internet network without a computer.
2. Built in network browser interface, you can operate the switch and check the state without any special program. Support multiple browser , such as Internet Explore, Netscape, Mozilla (Linux).
3. Control 4 AC outlet equipment at the same time.
4. Supported HTTP, SMTP, INTERNET- fixed IP, DDNS, DHCP, LAN - virtual IP
5. Security passwords identify. Easily installed and can be updated online.
6. Supported serial port communication, indicate all kinds of real time state of 9258.
7. Separated LED indicates the state of each switch.
8. Develop tool (SNMP) is provided. It can be modified to meet the user's special need.
9. Safely designed for high voltage resistance and protection for leakage of electrical currency, using nonflammable material
10. It can be used either separately or together with other products of AVIOSYS such as IP Kamera, IP Video and IP Sensor 9201 in all-directional network security monitoring, control and detection.

Specification:

Maximum rated voltage: 250V AC, 24V DC
 Maximum rated currency: **(Total) 15A AC/DC,**
 Maximum rated currency: **(Individual) 6A AC/DC**

Action delay: Max 10ms

Working temperature: 0~ 70°C

2. Specification

Package contents

✍ One set of 9258



✍ Option;

RJ45 (Cat5) net wire



✍ Option : Power wire

Minimum System Requirements

- Intel Pentium III 300MHz or above/compatible AMD CPU
- WINDOWS operating system (IE5.0+SPI) & LINUX
- Minimum 64MB RAM
- VGA Card: supported direct draw
- Network card with RJ45 port & Ethernet HUB or Switcher
- Internet network (Ethernet, ADSL or other ways, depends on whether you need far end control ability or not)

NOTICES:

1. IP Power 9258S : for **220-250V**, please use **power (IN) wire at 10A current..**
Max output current: (total) 10A. Max (individual) 6A.
2. IP Power 9258T : for **100-110V**, please use **power (IN) wire at 15A current..**
Max output current: (total) 15A. Max (individual) 6A .

3. Interface Description

IP Power 9258

Front interface shown below:

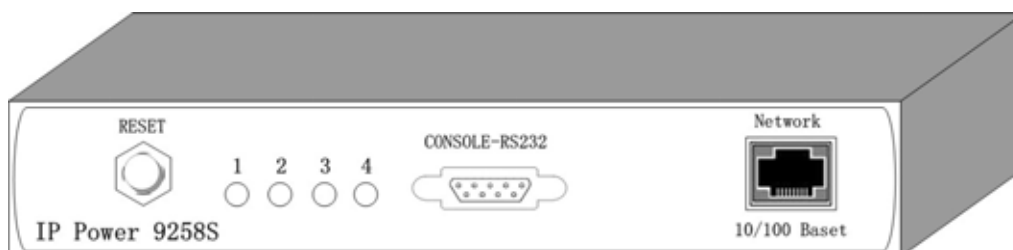

From left to the right

1. RESET: self-protect AC reset button. IP Power 9258 can cut off the power supply of outlets automatically if there is a shortcut or current overload. After user having solved the problem, push the **reset** button, the AC power supply will become normal.
2. LED: 4 LED indicator lights. If the LED is on, means the corresponding outlet is power on.
3. RS232 port: provide the power output state.
4. RJ45 Ethernet port: link to the net wire.

Rear interface shown below:

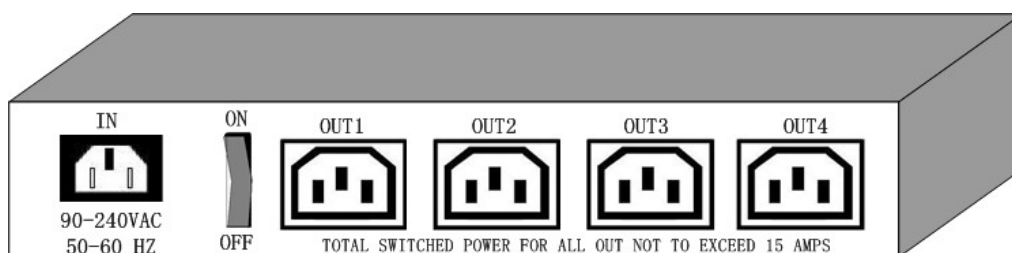

Port description (from left to the right)

1. 90-240VAC power input port
2. Power switch: the power switch ON /OFF of IP Power 9258.
3. OUT 1- 4: 4 individually switched AC outlets

4. Hardware & Software installation

Before you start to use IP Power 9258, please follow the steps below

- Check the package to make sure the contents is complete.
- Prepare one Ethernet HUB or Router
- Check the voltage of the power supply to make sure it is AC 110-240 volt
- Please confirm the specification of your power cable.
 - IP Power 9258S : for **220-250V**, please use the **10A** power cable.
 - IP Power 9258T : for **100-110V**, please use the **15A** power cable.

Hardware installation

- 1 Connect the 9258 to HUB through network wire.
- 2 Connect the HUB or Router to the internet (may through ADSL/XDSL modem).
- 3 Connect the power adapter to the 9258.
- 4 Connect the power adapters of under control electric equipment to corresponding out port of 9258.

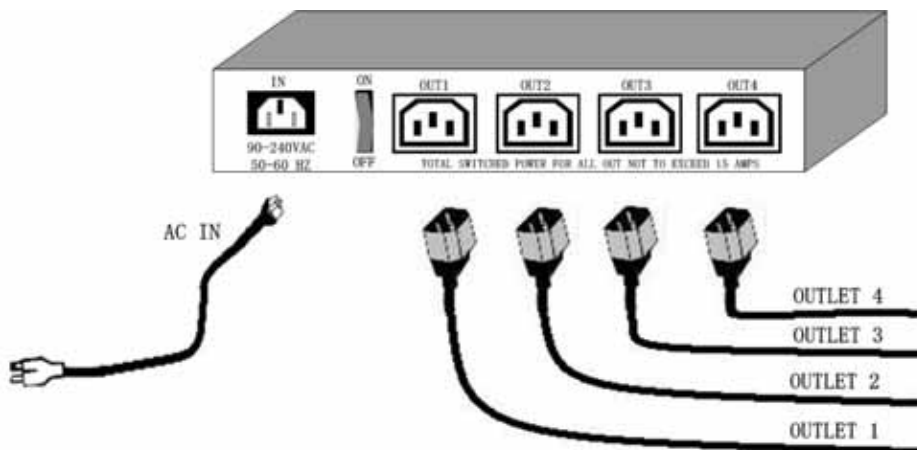

Turn on your computer and the power adapter of IP Power 9258

- ◆ for 220-250V, please use power wire can support 10A current..

Max. output current: (total) 10A , (individual) 6A.

- ◆ for **100-110V**, please use **power wire can support 15A current..**

Max. output current: (total) 15A , (individual) 6A

Software installation

Having connected the power supply and network wire with RJ45 port to the 9258, please install the software by following the steps below:

1. Start your computer, put the installation disc in the CDRom, then find the file named ipeditv3.exe in the installation disc.
2. Copy the file to your desktop or any directory you want it saved to.
3. Start the initial setting process following the construction in next section.

5. Initial Settings

Initial setting through the Ethernet

1. Double click the EditV3.exe



2. All the IP 9200 series, IP Kamera 9000 series/IP Video 9100 series in the same subnet of the Ethernet will be found and be display in the window by the software. The default name of IP Power 9258 is IP 9258.

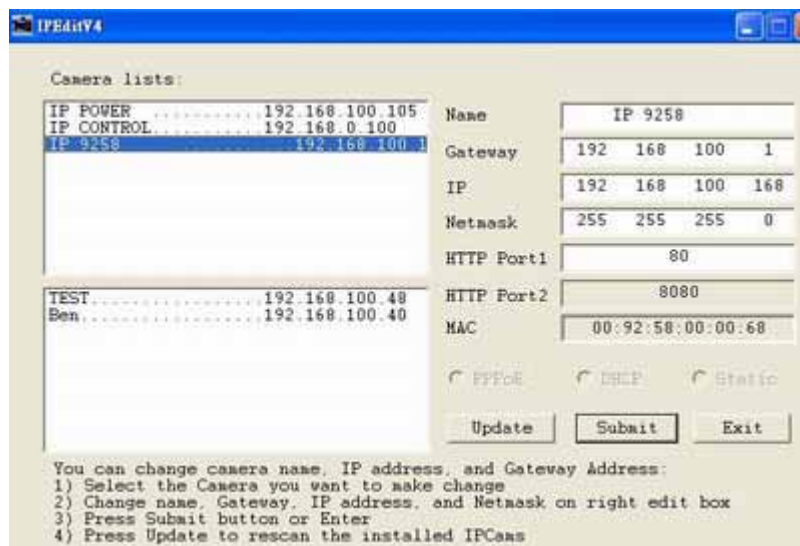

3. Click the equipment's name that you want to edit in the left of the window; it will turn fuscous, the equipment's name and IP address will display in the windows, you can rename (use numbers and letters). After that, click the update button and the new setting will be work in 20 seconds.
4. Double click the name of the equipment you want to control, the IE browser window will open and connected to this equipment in that Ethernet automatically. You also can type the IP address of the 9258 in the IE browser to open the web page of 9000. We suggest you to update the IE to version 6.0 with SP1 or higher if your IE notices you the security level is too low to open that web page.

NOTICE:

1. Make sure the RJ45 network wire have been connected correctly and the 9258 are power on.

2. IP Power 9258's default setting is fixed IP address: 192.168.10.100. The IP address of your computer should be in the same subnet with that of IP Power 9258's, so that you can open the control web page. In the figure above, the IP address of IP Power 9258 is 192.168.100.168. You can make sure the IP address of your computer first, then use the **ipedit.exe** to modify the IP address of IP Power 9258. After that, your computer can connect to the IP Power 9258.
3. If user can not enter the control web page, please set the IP address of IP Power 9258 and your computer in the same subnet. User can obtain the computer's IP address, subnet mask, and default gateway through the following method.

start → run → type in "cmd" → then open the MS-DOS window, now type in "ipconfig"

```

C:\WINDOWS\System32\cmd.exe
Microsoft Windows XP [版本 5.1.2600]
(C) Copyright 1985-2001 Microsoft Corp.

C:\Documents and Settings\Chiu>ipconfig

Windows IP Configuration

Ethernet adapter 區域連線:

    Connection-specific DNS Suffix . : 
    IP Address. . . . . : 192.168.100.31
    Subnet Mask . . . . . : 255.255.255.0
    Default Gateway . . . . . : 192.168.100.254

C:\Documents and Settings\Chiu>
  
```

The last number of the IP address (default is 100) can be any number between 1~254, but cannot be the same with that of the computer's. If you want to use it at home, you can enter the web page by typing in the IP, the IE, or using ipedit.exe program.

***Same subnet** : means the first three parts of the IP address must be the same, such as XXX.XXX.X.abc. For example, **192.168.1.100** and **192.168.1.123** are in the same subnet.

5. The default username and password of IP Power 9258 are:

Username: admin
Password: 12345678

6. Control and settings through the Internet Explorer

IP9258 Login

Please enter user name and password.

User Name

Password

Type the new IP address of IP Power 9258 in the address field and you can enter the login web page. Input the default password 12345678, or the password set by you, click **OK**, and you can then enter the Web Control page.

Control the power supply of outlets

Having entered the Web Control page of 9258, click the **SET POWER** button on the left, you can enter the IO setting page as the following figure:

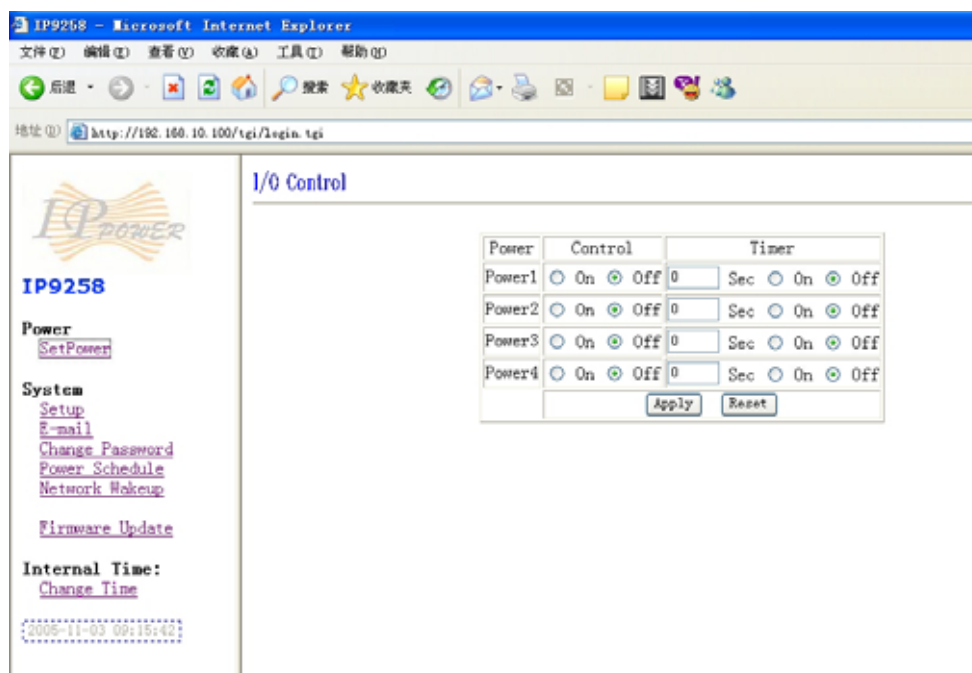

IP Power 9258 can control 4 outputs individually at the same time. User can choose power on or power off with an electrical outlet. User may fill in the corresponding columns with the delay time you wish in seconds, then choose the action after delay to be **on** or **off**.

Power Supply State Query

Click the “ **Set Power**” button on the left, the page will be refreshed. The state of each electric outlet will be displayed in column control.

System Settings of 9258

User can set the password, IP address, e-mail address, timer setting, online firmware update, and the time of 9258 through the **system settings**.

1. Setting the password for IP Power 9258 :

Click the “ **Change password** “ button on the left you can enter the change password page. The default password of 9258 is 12345678.

User can change it into any password (not longer than 8 bit), then click **apply** button to save the change.

Change Password

Old Password:

New Password:

Confirm New Password:

2. Setting the IP address for IP Power 9258:

Click the “ **Setup** “ button on the left side; fill in the proper IP address, Subnet Mask, Default Gateway, DNS. If you choose to use DHCP, please make sure that your network support DHCP service so the IP Power 9258 will search and gain an IP address automatically when it starts.

System Configuration

ALL CAHNGED MUST BE RESTART TO TAKE EFFECT.				
IP Address:	<input type="text" value="192"/>	<input type="text" value="168"/>	<input type="text" value="10"/>	<input type="text" value="100"/>
Subnet Mask:	<input type="text" value="255"/>	<input type="text" value="255"/>	<input type="text" value="255"/>	<input type="text" value="0"/>
Default Gateway:	<input type="text" value="192"/>	<input type="text" value="168"/>	<input type="text" value="10"/>	<input type="text" value="1"/>
DNS:	<input type="text" value="202"/>	<input type="text" value="103"/>	<input type="text" value="24"/>	<input type="text" value="68"/>
DHCP Client	<input type="radio"/> Enable <input checked="" type="radio"/> Disable			
BEEPER	<input type="radio"/> Enable <input checked="" type="radio"/> Disable			
Release Version:	0.9819 2005/10/28			
<input type="button" value="Submit"/> <input type="button" value="Cancel"/>				

2-1 IP address Settings: Ethernet (LAN) and Internet(WAN)

2-1-1 Local Area Network (LAN) :

In LAN, you can set a fixed IP address or gain it from a DHCP server automatically. We suggest to use a fixed IP address in order to let the other computers can visit the 9258.

Now type the new IP address in the address field of IE, you can visit the 9258. You also can use the ipedit.exe to find the IP Power 9258 and modify its IP address.

2-1-2 Work on Internet (WAN) :

User can set the IP provided by your ISP. If the IP Power 9258 has a public IP address, you can control it through the Internet. IP Sensor 9258 supports fixed IP, DHCP.

* IP Address: please type in the IP address provided by your ISP. If IP Power 9258 is working with a Router, please refer to the network settings of the Router.

* Subnet Mask : please type in the Subnet Mask provided by your ISP. If IP Power 9258 is working with a Router, please refer to the network settings of the Router.

* Default gateway: please type in the Default Gateway provided by your ISP. If IP Power 9258 is working with a Router, please refer to the network settings of the Router.

* DNS Server : please fill in the IP address of DNS server. If you are in Taiwan, you can set it to 168.95.1.1.

* DHCP Clients: Enable– activate DHCP service. DHCP will assign IP address for each PC. Disable – shut down the DHCP service. You can set the IP address by yourself.

* Beeper : Enable – activate the beeper . Disable – turn off the beeper.

If you control the 9258 through the web page, the beeper will beep once when the operation work.

NOTICE:

- 1) IP address format : xxx.xxx.xxx.xxx: yyyy. yyyy means the port number, Ranging from 1 to 32767.
- 2) Subnet Mask: from 0 to 254 (xxx.xxx.xxx.0 ~ xxx.xxx.xxx.254)
- 3) If DHCP is disabled, user must set the TCP Port and default Gateway .If DHCP is enabled, then the TCP port will be preset to 80(xxx.xxx.xxx.xxx: 80) and the default gateway will be set by the DHCP server, too..
- 4) If the TCP port you set is not 80, your should type in the whole IP address and port in IE or Netscape, such as <http://xxx.xxx.xxx.xxx:yyyyy> , or you can use the ipedit.exe to login into the virtual IP of IP Power 9258.

3. EMAIL SETTINGS:

When you finished the e-mail settings, you can set to let IP Power 9258 send its IP address automatically.

Setup Email

MailServer:	abcd.com
Password:	*****
Sender:	123@abcd.com
Receiver1:	456@abcd.com
Receiver2:	789@efgh.com
Receiver3:	
Subject:	9258 IP address
MailBody:	update
<input type="button" value="Save"/> <input type="button" value="Send"/>	

For example:

Mail Server: abc.com
 Password : XXXXXX
 Sender: 123@abcd.com
 Receiver 1: 456@abcd.com
 Receiver 2: 789@efgh.com
 Receiver 3:
 Subject: 9258 IP address
 MailBody : Update

- 1.) Mail Server : the server sends the e-mail out.
Please make sure the server is an available mail server.
- 2.) Password : the password of this mailbox is no longer than 8 English letters.
- 3.) Sender : please fill in the name of sender. The Mail Server must support SMTP and these fields must be filled in correctly.
- 4.) Receiver :no longer than 50 English letters. Please use blank space to separate two receiver's e-mail address. After you have finished this setting, you will receive the email to inform you the IP address of the IP Power 9258 every time you enter the webpage.
- 5) Subject : the subject of the mail to be no more than 50 English letters.
- 6) Mail Body : please type the content of the mail here, it cannot be left empty.

After you have finished all of the above settings, click "**SAVE**" button to save your settings.

4. Control the IP Power 9258 through Time Schedule :

User can control the time when 9258 starts or stop through preset time schedule. Click the power schedule on the left of the page; you can enter the time schedule setting

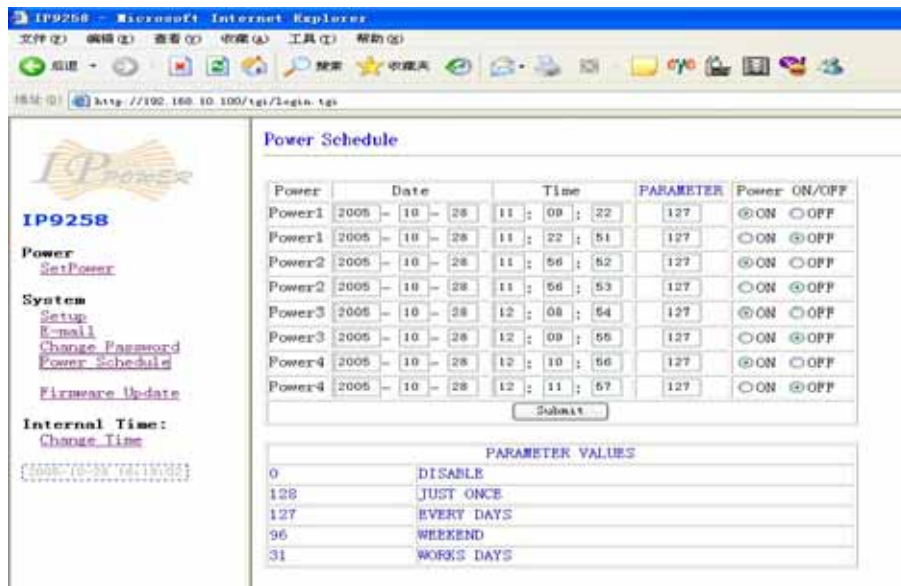

If user wishes to control the power in one outlet of IP Power 9258, you can fill in the time in the power control column and choose on or off.

The valid values of the parameter and its meanings:

Value : meaning

0: disable

128: once

127: every day

96: every Saturday and Sunday

31: every Monday to Friday.

* In following setting, the parameter is set to 0; it means this timer setting is disabled.

Power	Date	Time	PARAMETER	Power ON/OFF
Power1	2005 - 10 - 30	16 : 58 : 10	0	<input checked="" type="radio"/> ON <input type="radio"/> OFF

* In following setting,

Power	Date	Time	PARAMETER	Power ON/OFF
Power1	2005 - 10 - 30	16 : 58 : 10	128	<input checked="" type="radio"/> ON <input type="radio"/> OFF
Power1	2005 - 10 - 31	05 : 02 : 30	128	<input type="radio"/> ON <input checked="" type="radio"/> OFF

The parameter of power1 first line is set to " 128 " and set " ON " which means power 1 will be on at the scheduled time for one time , power1 will be on (connect) at 2005-10-30 16:58:10.

The parameter of power1 second line is set to " 128 " and set " OFF " which means power1 will be off at the scheduled time for one time , power1 will be off (connect) at 2005-10-30 16:58:10.

After order of power1 has been done , power1 will be disabled and the parameter will be set to 0 automatically.

* In following setting, the parameter is set to 127 which means power1 will be ON at 16:58:10 everyday from date 2005-10-30.

Power	Date	Time	PARAMETER	Power ON/OFF
Power1	2005 - 10 - 30	16 : 58 : 10	127	<input checked="" type="radio"/> ON <input type="radio"/> OFF

* If want to control every Monday to Friday , set the parameter at " 31 " .

* If want to control every Saturday and Sunday , set the parameter at " 96 " .

5.Firmware update:

User can gain more functions for IP Power 9258 through firmware update.

Click the firmware update on the right side of the page; the following window will pop up.



Click update button, the following window will pop up.



Click the Brower button to find the corresponding update file (you can download it from our web site or ask it from the dealer), then click Update button to start update firmware. When the update is finished, you must wait one minute before you restart the IP Power 9258.

NOTICE:

- * **Before running the online update program, please make sure that the TCP port is set to 80,or the online update may fail.**
- * **If the update fails, you must enter the IP address before update and start the update procedure again.**
- * **Please check with your reseller /distributor / importer for the update news.**

6. Internal Clock Settings:

User can enter the internal clock settings through clicking the change time button on the left side of the web page.

Setup DateTime

DateTime: (yyyy-mm-dd HH:MM:SS)									
2005	-	11	-	3	9	:	13	:	10

Type in the year (4 digit), month (2 digit), date (2 digit), hour (2 digit), minute (2 digit), second (2 digit) in turn, then click set button to finish the setting.

7. Check 9258 status though SNMP

9258 support SNMP V1 and V2 , user can use snmp program to get the status of each port in 9258.

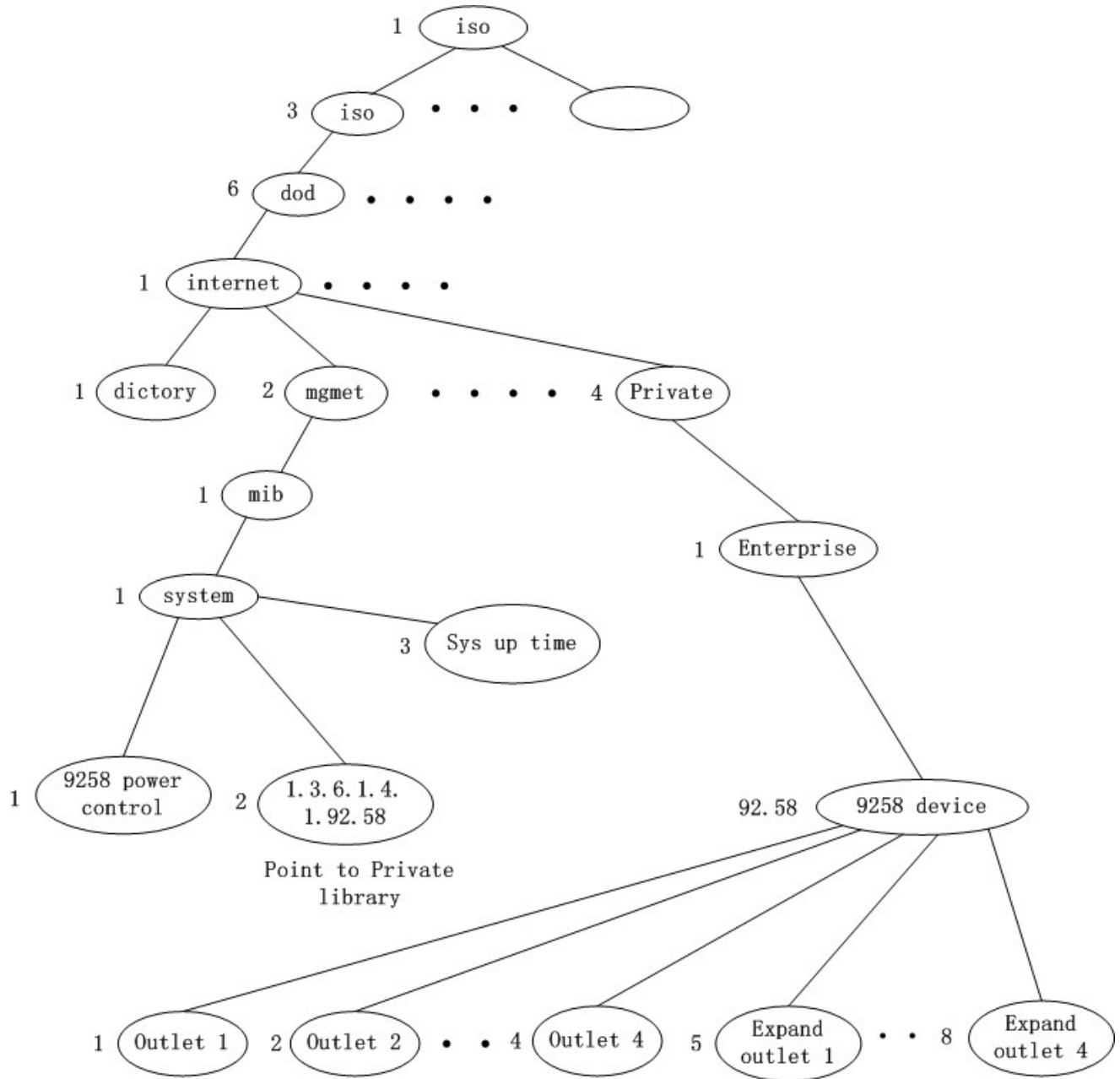

Return value =1 ; the relevant outlet is power on
 Return value =0 ; the relevant outlet is power off

8. Control and Settings Through HTTP Order

User can control the 9258's action directly though the HTTP orders.
The format of the HTTP order is :

http://username:password@XXX.XXX.XXX.XXX/XX.cmd?para1=*+para2=*+para3=*..

Explanations of each part of the order:

Username : 9258's username, default username is **admin**

Password : 9258's password, default password is **12345678**

XXX.XXX.XXX.XXX the IP Address of 9258

XX.cmd : the function module of 9258

para1 - para3 parameters

The function module of 9258 :

1. SetPower.cmd

to control IO , refer following parameter

out1 : this parameter set as 0 (power1 off) or 1 (power1 on)

out2 - out8 : similar as out1

2. set.cmd

to setup username , password device name and network parameter

parameter as follow:

parameter name	meaning
use1	device name
key 1	administrator username
SMA	administrator password
Sev	Sending Mail Account - setup the account sending e-mail
Skey	setting mail server
RMA	setting mail server password
IP	receiver e-mail account
Port	IP address
Mask	IP address port
Gate	IP address subnet mask
DNS	IP Address gate way
AIP	DNS address of server
Aport	Agent IP - setup agent server address
DHCP	Agent IP port - setup port of agent IP
	Parameter " 0 " or " 1 " to control if use DHCP.

3. update .cmd

dfult: Parameter " 0 " or " 1 " to control default setting .

Example 1: control the power supply of 9258:

<http://admin:12345678@192.168.1.10/SetPower.cmd?p60=1+p61=0+p62=1+p63=0>

This order will control one IP Power 9258 whose IP address is **192.168.1.0**, user name is **admin** and password is **12345678**. This order will turn on the power of outlet1 (p60), turn off the power of outlet2 (p61), turn on the power of outlet3 (p62), turn off the power of outlet4 (p63).

When this order is sent, the IP Power will return the following message:

```
<html>P60=1,P61=1,P62=1,P63=0</html>
```

NOTICE:

1. Each parameter must be separated by +. User also can control the power supply of one outlet only. For example:

<http://admin:12345678@192.168.1.10/SetPower.cmd?p61=0>

2. If the IP Power 9258 is extended to 8 outlets by adding an expansion unit, then outlet5 to outlet8 is p64-p67.

3. Please write the http order strictly according to the format and please note the font in capital or not.