

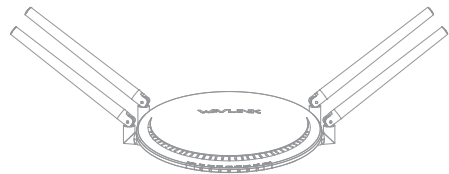

# Quick Start Guide

»»» Wireless AC1200 Dual Band Router

REV.E2



WAVLINK (@WavlinkOfficial)  
WAVLINK SUPPORT (@WavlinkTechSupport)

## Get to know your Router

### Default Parameters

Default URL:  
<http://wifi.wavlink.com>  
Default IP:  
**192.168.10.1**  
Login Password:  
**admin**

2.4G SSID:  
**WAVLINK\_XXXX**  
5G/AC SSID:  
**WAVLINK\_AC\_XXXX**  
TouchLink SSID:  
**WAVLINK\_XXXX-Touch**

### In the box

- 1 x Wireless AC1200 Dual Band Router
- 1 x RJ45 Ethernet Cable
- 1 x Power Adapter
- 1 x Quick Start Guide

## Hardware Connection

**Step 1:**  
Unplug or power off your modem.

**Step 2:**  
Cable your modem.

**Step 3:**  
Connect your router to a power source.

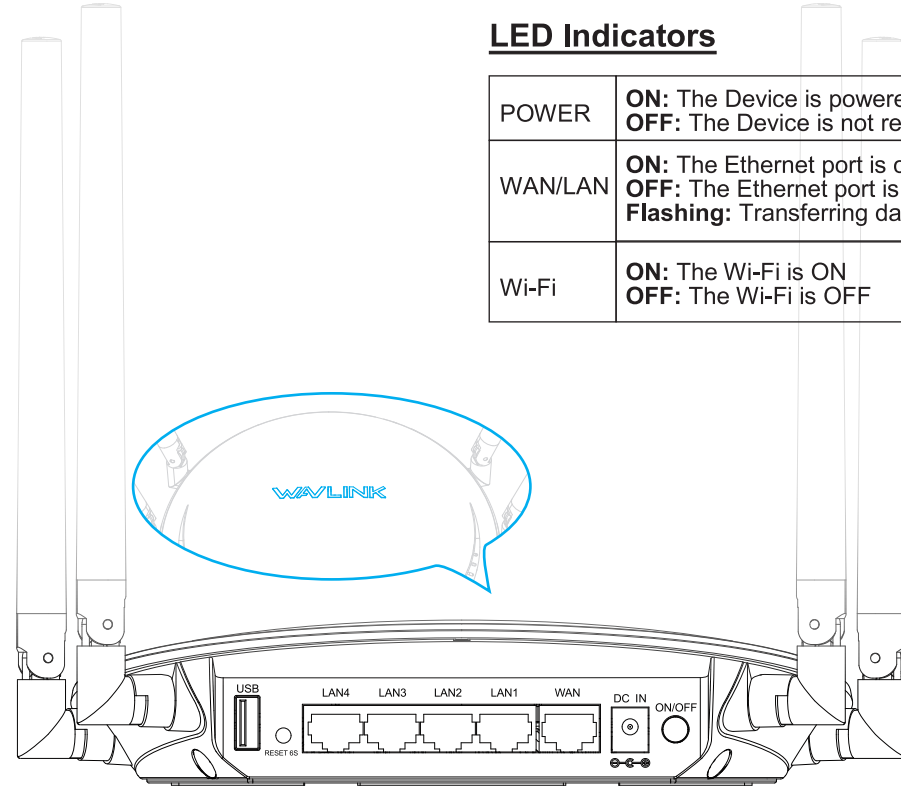
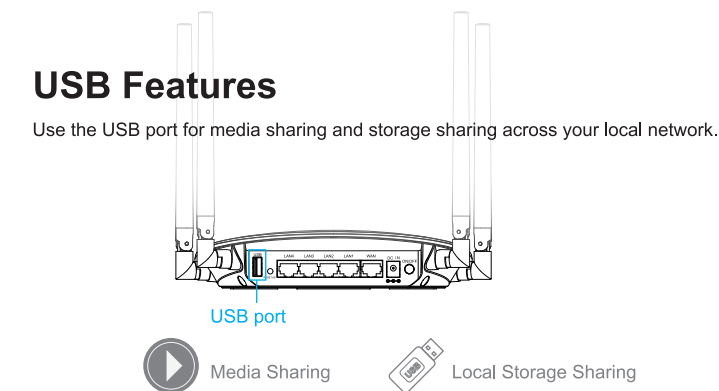
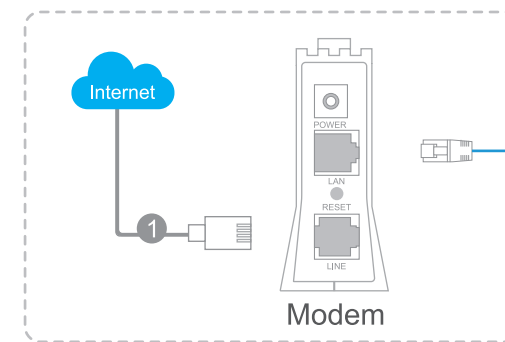

### The WAVLINK logo (LED) indicator:

**Blue light:** Internet is functional  
**Flashing(Red light):** Internet is disconnected  
**Flashing(Blue light):** TouchLink mode or WPS is on open status

### LED Indicators

POWER	<b>ON:</b> The Device is powered on <b>OFF:</b> The Device is not receiving electrical power.
WAN/LAN	<b>ON:</b> The Ethernet port is connected <b>OFF:</b> The Ethernet port is disconnected <b>Flashing:</b> Transferring data to/from a network device
Wi-Fi	<b>ON:</b> The Wi-Fi is ON <b>OFF:</b> The Wi-Fi is OFF

### Hardware Overview

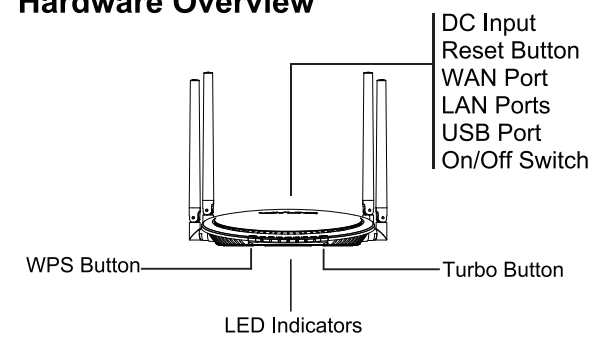

**WPS Button:**  
Press and hold **2** Seconds for WPS one-key encryption and connection

**Reset Button:**  
Press and hold **6** Seconds for system reset

## Patented TouchLink Technology

Make Sharing Easy | Maintain Security

- No need to share your sensitive personal Wi-Fi passwords with your guests.
- No more hard times to try to figure out the passwords that you have forgotten.
- No more compromises with passwords that are too difficult to remember.

1. Touch the WAVLINK sensing area (1), the WAVLINK (LED) will be flashing (blue light).

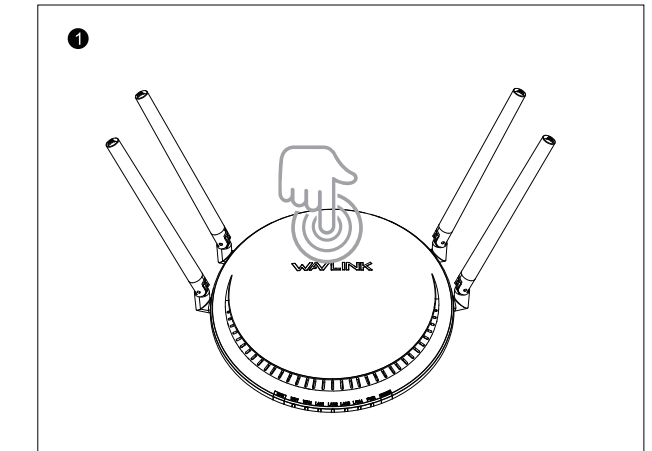

2. Choose the SSID(Wi-Fi Name) with 'Touch', and then confirm the connection (2).



**NOTE:**  
After touching the WAVLINK sensing area, the WAVLINK(LED) will be flashing (blue light) and you can connect to the SSID(Wi-Fi Name) with 'Touch' within without the requirement of accessing the Wi-Fi password within 2 minutes.

## TURBO Technology

One push to optimize your network

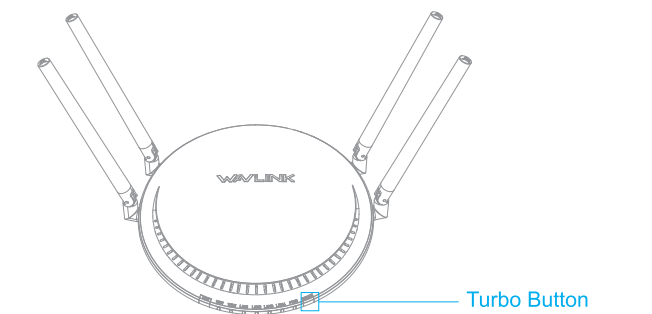

**Note:**  
The WAVLINK logo (LED) will be flashing about 5 seconds after pushing the TURBO button.

- For optimum performance, position your router's antennas as shown in the drawing below.

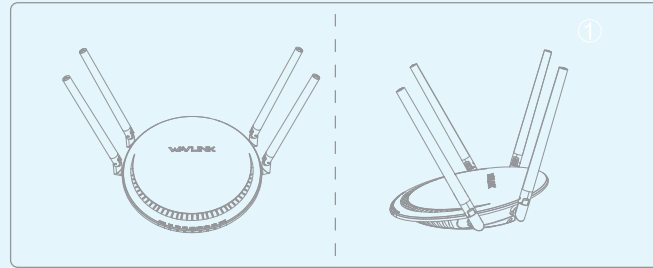

- If you want to hang it on the wall, position your router's antennas as shown in the drawing below.

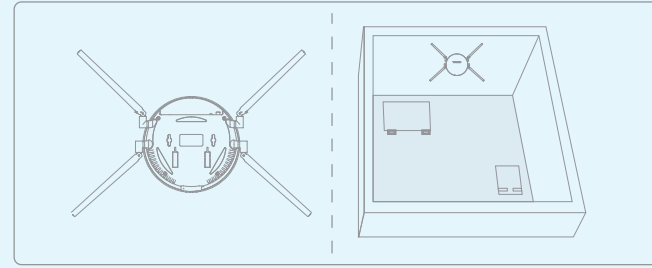

- Your router needs to be connected to a modem. So this may limit where you place it, depending on the length of the ethernet and power cables. If possible, place your router in plain view like on a shelf or TV stand. It also helps to choose a central location at eye level.

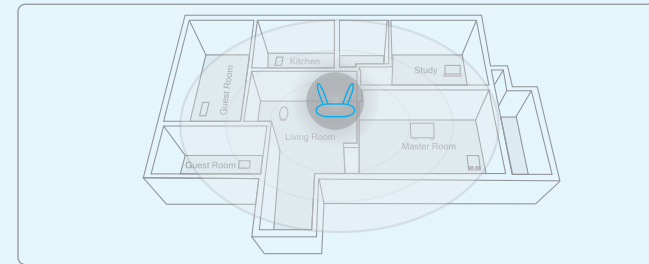

## Configure via Web Browser

### 1 Connect your computer to the Router (Wired or Wireless).

#### •Wired

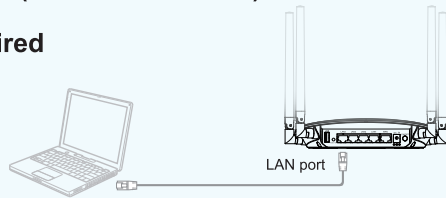

#### •Wireless

Connect wirelessly by using the SSID (WiFi Name).

#### For Windows Users

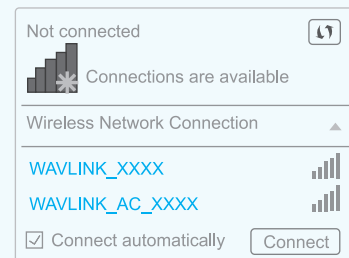

- Turn your laptop's Wi-Fi ON if it is OFF.
- Click the Wi-Fi icon on the taskbar and connect to the Device's network: **WAVLINK\_XXXX** or **WAVLINK\_AC\_XXXX**.

#### For Mac OS X User



- Turn your laptop's Wi-Fi ON if it is OFF.
- Click the Wi-Fi icon on the top right corner of the screen, and connect to the Device's network: **WAVLINK\_XXXX** or **WAVLINK\_AC\_XXXX**.

### 2 Configuration

- Enter <http://wifi.wavlink.com> or <http://192.168.10.1> in the address bar of a web browser. Use **admin** for login password, and then click **Login**.

**Note:** If the login window does not appear, please refer to FAQ>A1.



- After login, the status page will appear, showing full details and Internet connection status of this router.

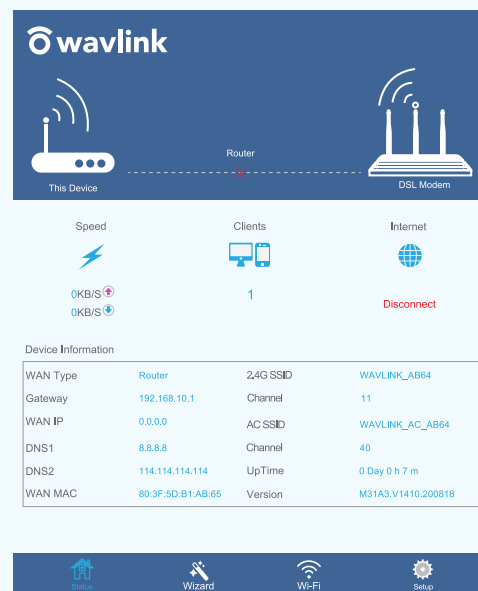

- Click the **Wizard** section, and choose **Router mode** for further configuration, or you can choose other modes that fit your needs.

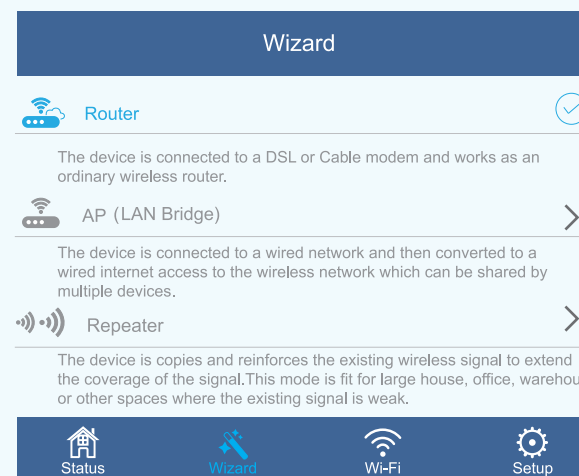

**Note:** If you select WISP mode, the router will work as a Wi-Fi range extender.

- Select your **WAN type: PPPoE, Static IP, or DHCP (Dynamic IP)**, and then enter the information provided in the corresponding fields.

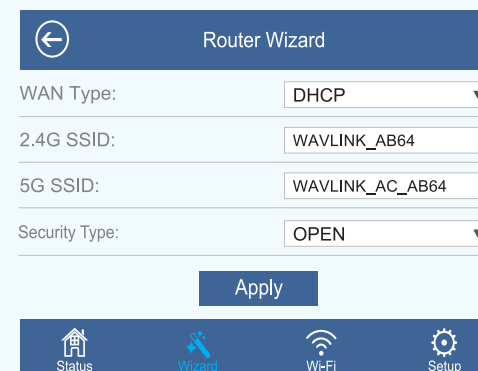

**Note:** If you are not sure about your Internet type, please contact your Internet Service Provider (ISP). If you use DSL line and you are only provided an account name and a password by your ISP, choose **PPPoE**. If you use cable TV or fiber cable, choose **Dynamic IP**. If you are provided more information such as IP address, Subnet Mask and Default Gateway, choose **Static IP**.

- Click Apply and wait for the installation process to complete.

### Change Wi-Fi name and password

- Click **Wi-Fi** -> **Wi-Fi Configuration**.
- Configure and click **Apply** button to confirm.

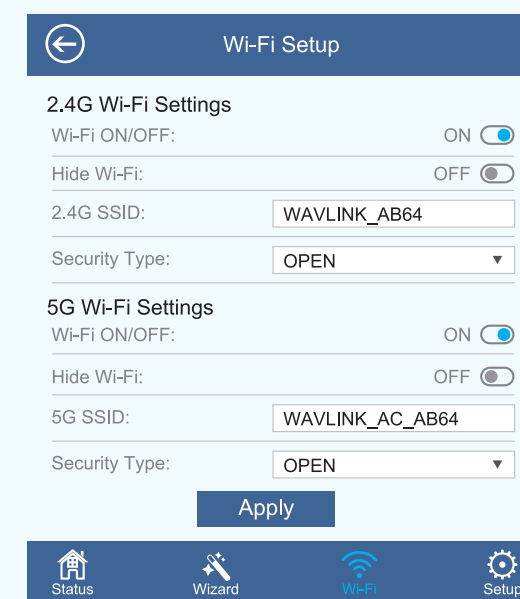

### Change login password

- Click **Setup**->**Login Password**.
- Enter the old password. Then enter the new password (case-sensitive) and click **Apply** button to confirm.

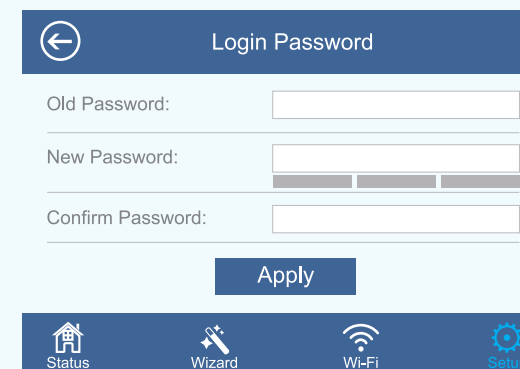

- Use the new password for future login attempts.

### \*\*\*Upgrade the Firmware

- \* Firmware upgrade can fix bugs of the Device. However, We **DO NOT** recommend you upgrade the firmware of the Device if it works properly.
- \* Warranty voids if you interrupted the upgrade procedure.

## FAQ (Frequently Asked Questions)

### Q1. Why doesn't the login page appear after entering <http://wifi.wavlink.com>?

- Make sure your computer is set to obtain an IP address automatically.
- Verify if <http://wifi.wavlink.com> or <http://192.168.10.1> is correctly entered in the web browser. Alternatively, enter <http://192.168.10.1> in the web browser.
- Use another web browser and try again.
- Reboot your router and try again.

### Q2. What can I do if I cannot access the Internet?

- Check if the Internet is working normally by connecting a computer directly to the modem using an Ethernet cable. If it is not, contact your internet service provider.
- Open a web browser, enter <http://wifi.wavlink.com> or <http://192.168.10.1> and run the Quick Setup again.
- Reboot your router and try again.

### Q3. How can I restore the router to its factory default settings?

- While the router is powered on, press and hold the **Reset** button on the back for 6 seconds.

### Q4. What can I do if I forget my Administration Management password?

- Refer to FAQ > Q3 to reset the router, and then use the default **admin** (all lowercase) to login.

### Q5. What can I do if I forget my wireless network password?

- Log in the router's web management page at <http://wifi.wavlink.com> or <http://192.168.10.1>, and go to **Wi-Fi**, you can find your wireless network password here.

## GNU General Public License Notice

This product includes software codes developed by third parties. These software codes are subject to either the GNU General Public License (GPL), Version 2, June 1991 or the GNU Lesser General Public License (LGPL), Version 2.1, February 1999. You can copy, distribute, and/or modify in accordance with the terms and conditions of GPL or LGPL. The source code should be complete, if you want us to provide any additional source code files under GNU General Public License (GPL), please contact us in these matters. We are committed to meeting the requirements of the GNU General Public License (GPL). You are welcome to contact us local office to get the corresponding software and licenses. Please inform us your contact details (full address) and the product code. We will send you a software package with the software and license for free. The respective programs are distributed WITHOUT ANY WARRANTY; without even the implied warranty of MERCHANTABILITY or FITNESS FOR A PARTICULAR PURPOSE.

Please refer to the GNU General Public License Web site for further information.

<http://www.gnu.org/licenses/old-licenses/lgpl-2.0.html>

<http://www.gnu.org/licenses/gpl.html>

### WEEE Directive & Product Disposal



At the end of its serviceable life, this product should not be treated as household or general waste. It should be handed over to the applicable collection point for the recycling of electrical and electronic equipment, or returned to the supplier for disposal.