

CONCORD
CONNECTING TOGETHER

4K SMART TV BOX WITH BT

XC6010



! IMPORTANT SAFETY INSTRUCTIONS

TO REDUCE THE RISK OF FIRE AND ELECTRIC SHOCK, DO NOT EXPOSE THIS UNIT TO RAIN OR MOISTURE.

PLEASE NOTE: The lightning flash with arrowhead symbol within an equilateral triangle is intended to alert the user to the presence of uninsulated “dangerous voltage” within the product's enclosure that may be of sufficient magnitude to constitute a risk of electric shock. The exclamation point within an equilateral triangle is intended to alert the user to the presence of important operation and servicing instructions in the literature accompanying the appliance.

! IMPORTANT SAFEGUARDS



WARNING

RISK OF ELECTRIC SHOCK,
DO NOT OPEN!



WARNING: TO REDUCE THE RISK OF ELECTRIC SHOCK, DO NOT REMOVE THE COVER OR DISASSEMBLE THE PRODUCT. NO USER-SERVICEABLE PARTS INSIDE. REFER SERVICING TO QUALIFIED SERVICE PERSONNEL.

1. All the safety and operation instructions should be read before operating the unit.
2. The safety and operation instructions should be retained for future reference.
3. Comply with all warnings on the unit and in the operating instructions.
4. This unit is equipped with a polarized alternating-current line plug. If the plug fails to fit, try reversing the plug. If the plug still fails to fit, contact your electrician to replace your obsolete outlet. To prevent electric shock, do not use this polarized plug with an extension cord, receptacle or other outlet unless the blades can be fully inserted without blade exposure. If you need an extension cord, use a polarized cord.

Contents

Chapter 1: System Introduction	04
1.1 Environment	04
1.2 Package contents	04
Chapter 2: Remote Control	05
2.1 Introduction	05
2.2 Using your mobile phone to control the box	06
Chapter 3: System Connection	07
3.1 Installation guide	07
3.2 Connect TV box to TV and connect network	08
3.3 Set up your TV box	09
3.4 Sign into your account	09
Chapter 4: Main User Interface	10
4.1 Google assistant	10
4.1.1 Setting up the language for	10
4.1.2 Operating voice commands	11
4.2 Preloaded Apps	12
4.3 Settings, Internet status and the App drawer	12
4.3.1 Device setting	13
4.3.2 Preference setting	16
4.3.3 Remote & accessories	16
4.3.4 Personal setting	17
4.3.5 Accounts setting	17
4.4 Internet status	18
4.5 App drawer	19
Chapter 5 - How to Install / Uninstall Apps	19
5.1 How to install Apps from the Play store or through an APK installer	19
5.2 How to uninstall Apps	21
Chapter 6: Browse	21
Chapter 7: How to manage your files-ES File Explorer	22
Chapter 8: Tips on pairing your remote	22
8.1 Connecting the TV box to a keyboard	22
8.2 Add accessory	23
8.3 Activating pairing mode	24
8.4 Pairing	25
8.5 Pairing completed	25
Chapter 9 Troubleshooting	26
Chapter 10 Specification	27

Chapter 1: System Introduction

1.1 Environment

Operation: Temperature limitation: 0-40°C; Humidity limitation: 20-80%

Storage: Temperature limitation: 20—50°C; Humidity limitation: 10-00%

1.2 Package contents

Accessories	Quantity
TV box	1
Power adaptor	1
Remote control	1
HDMI cable	1
User manual	1

Chapter 2: Remote Control

2.1 Introduction

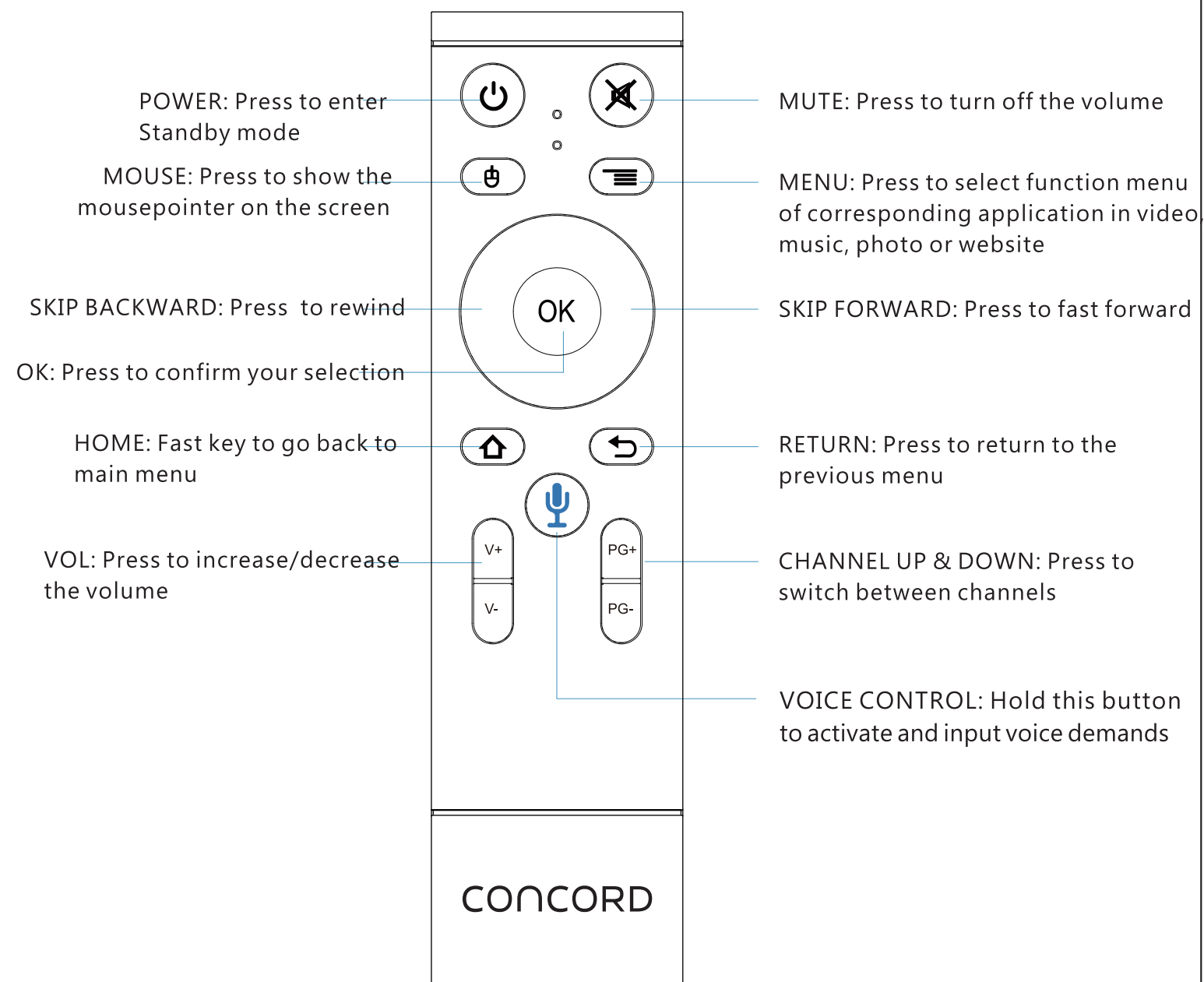

Please note: When you use the Voice Search function in Apps, please press the microphone knob on the remote to activate, then press and hold the microphone to speak.

2.2 Using your mobile phone to control the box

Download the APP on your mobile phone as follows (please note that the box and your phone need to be connected to the same Wi-Fi from one router):

For IOS: Download “Android TV Remote” from the APP store.

For Android: Download “Android TV Remote” from Google Play store.

Once you have downloaded the app, open it up, select "XC6010" and follow the prompts. Enter the code that pops up on the screen to pair your phone with the box.

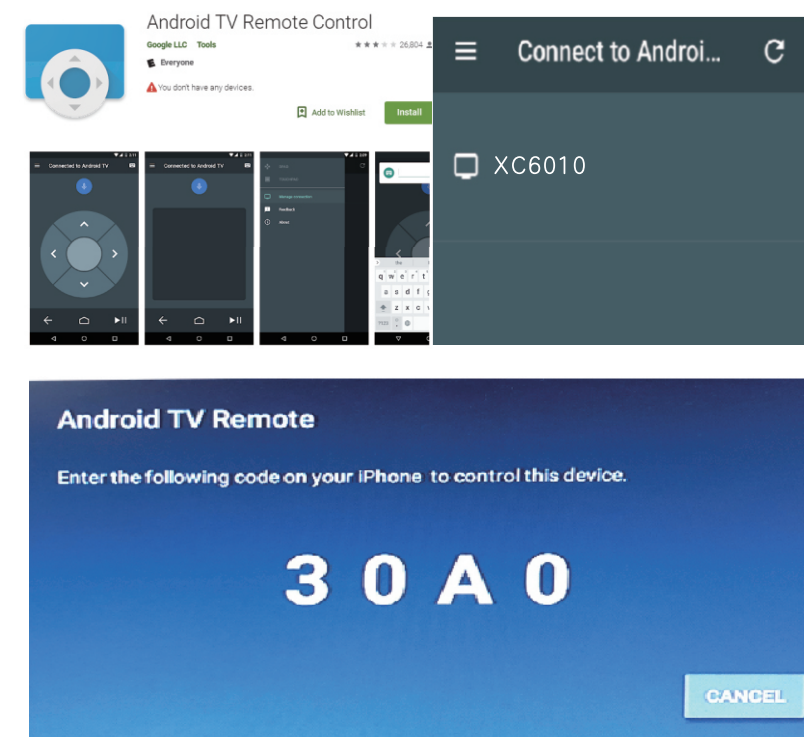

Chapter 3: System Connection

3.1 Installation guide

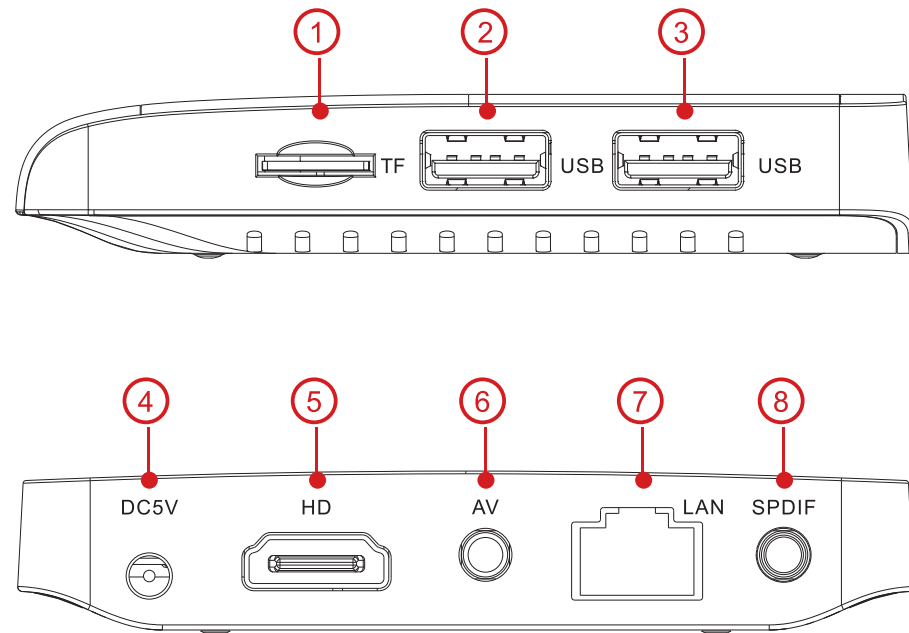

No	Item	Description
①	TF(SD card)	For your local storage device
②	USB HOST	Connects to an USB device.
③	USB OTG	Connects with a keyboard, mouse, or other USB device.
④	DC 5V	Connects to a power adapter.
⑤	HD	Connects the TV box to the TV set through HDMI cable
⑥	AV Out	CVBS video & L/R audio out; Connects to non-HDTV and/or speakers.
⑦	LAN	Rj45 Lan port for TV box internet connection
⑧	SPDIF	Coaxial digital audio output; Connects to amplifier.

3.2 Connect TV box to TV and connect network

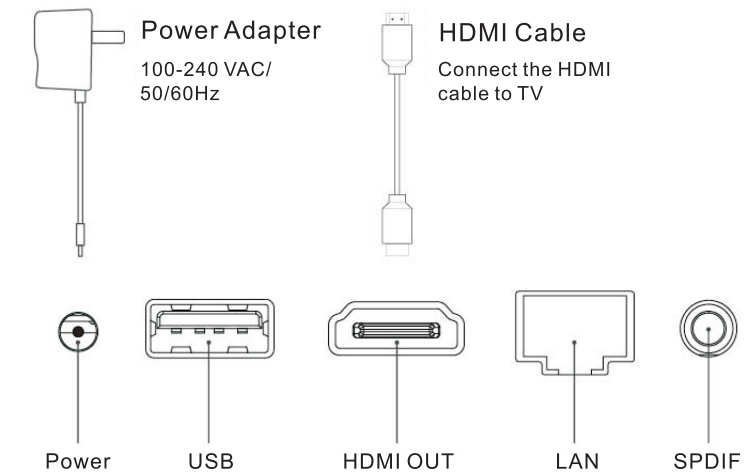

① Connect TV Box to TV

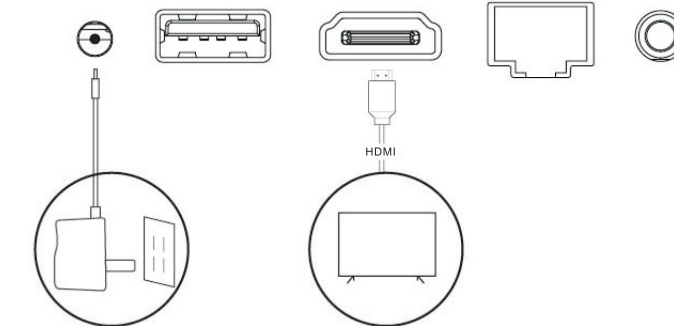

② Connect Network

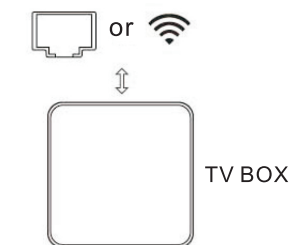

③ Connect to external devices such as a keyboard, mouse, USB drive, game controller, etc. through these two USB ports.

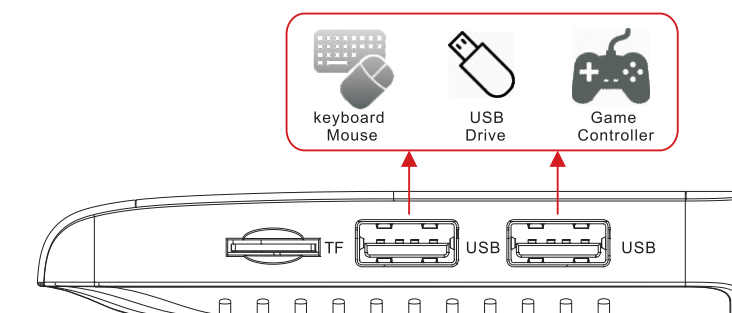

3.3 Set up your TV box

Turn on the box and follow the instructions to choose your preferred language, input your WiFi information, etc. until the set up is complete.

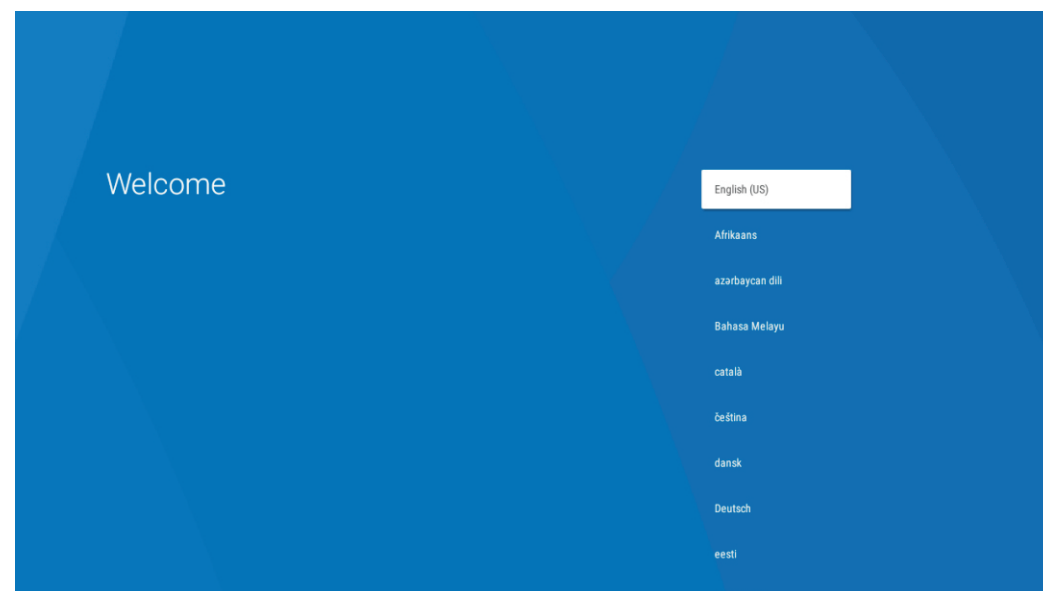

3.4 Sign into your account

You will be asked to sign into your account by either using your phone or laptop or by using your password. If you have not as yet created a Google account, then select "Use your Phone or Laptop" to create one. If you already have a Google account, then select the option "Use your Password".

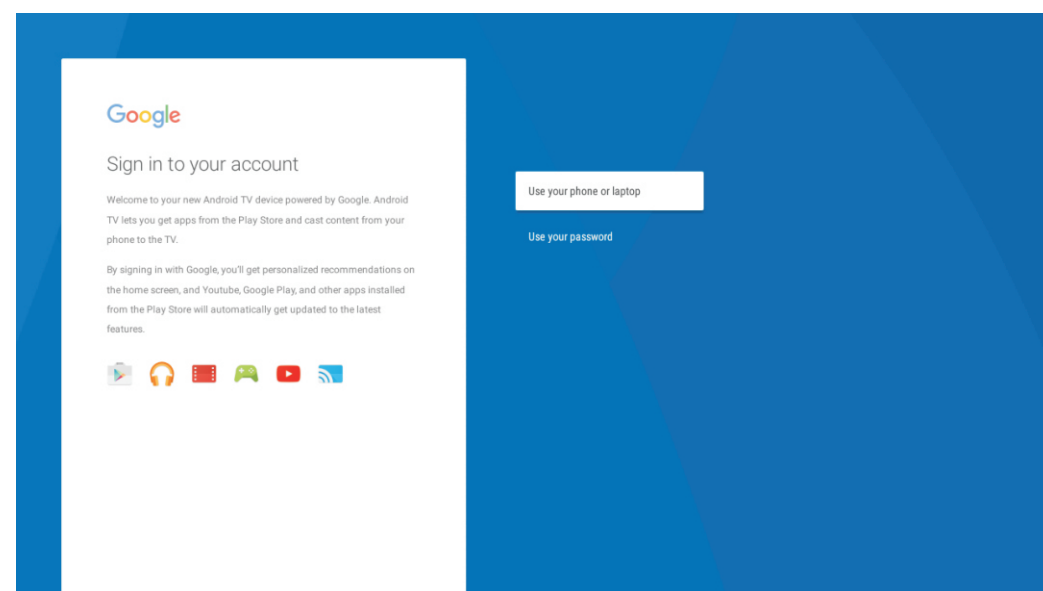

Chapter 4: Main User Interface

Once your unit is set up, it will automatically enter the Main User interface. Use your smart phone to control the unit.

4.1 Google assistant

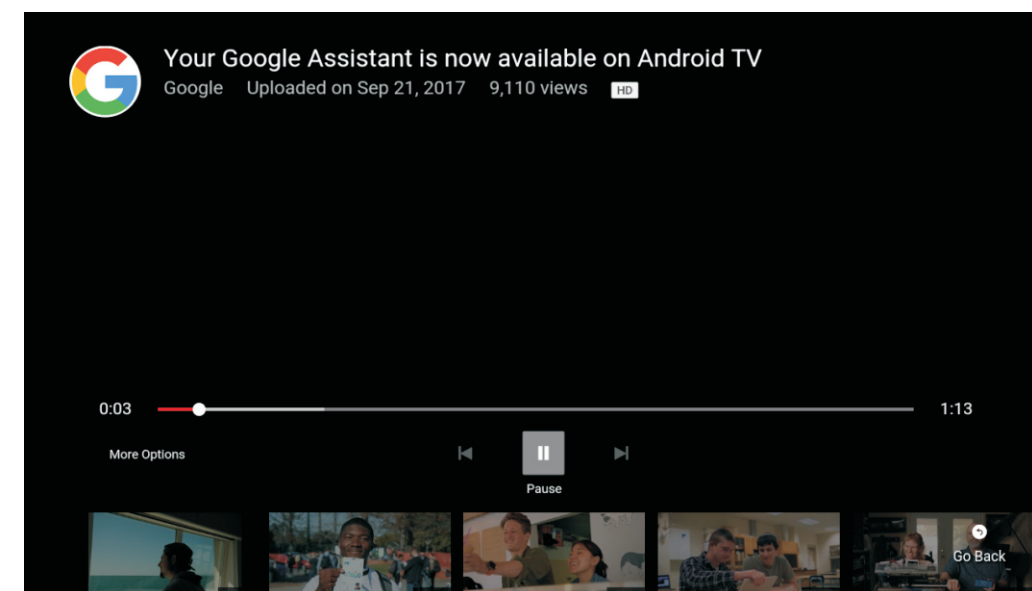

4.1.1 Setting up the language for voice commands

Choose your preferred language in settings when pairing your remote to a movie or TV show. For example, if you want to watch a movie or TV show in French, the default language needs to be set to French. You also then need to speak in French when inputting the voice commands.

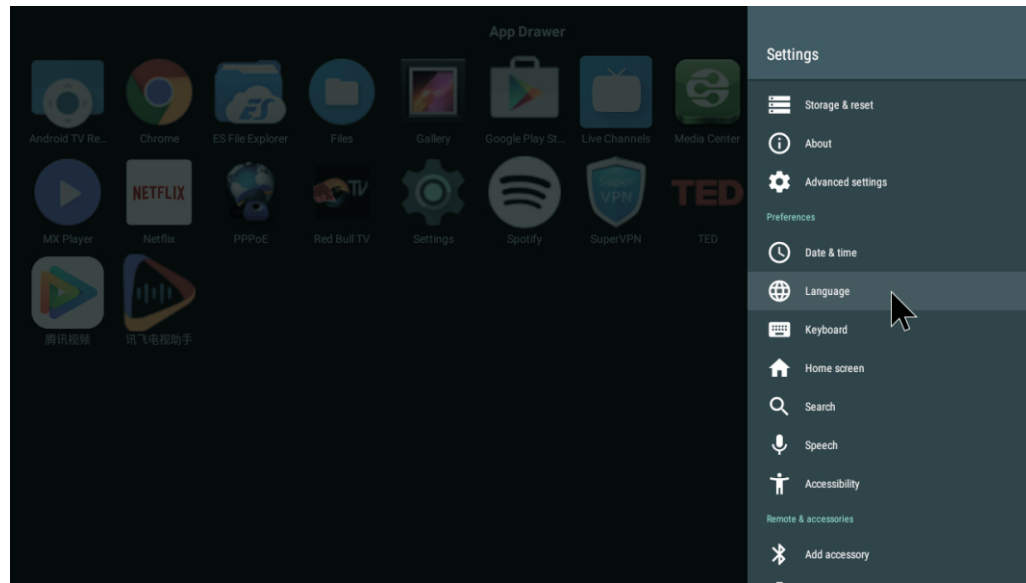

4.1.2 Operating voice commands

Press and hold the voice button on the remote control. Do not release until you have inputted a voice command. For example, if you are searching for information relating to KODI, input the voice command "KODI". All information relating to this subject will pop up. You can use voice search in the Main interface, on YouTube, Play Store as well as All Apps.

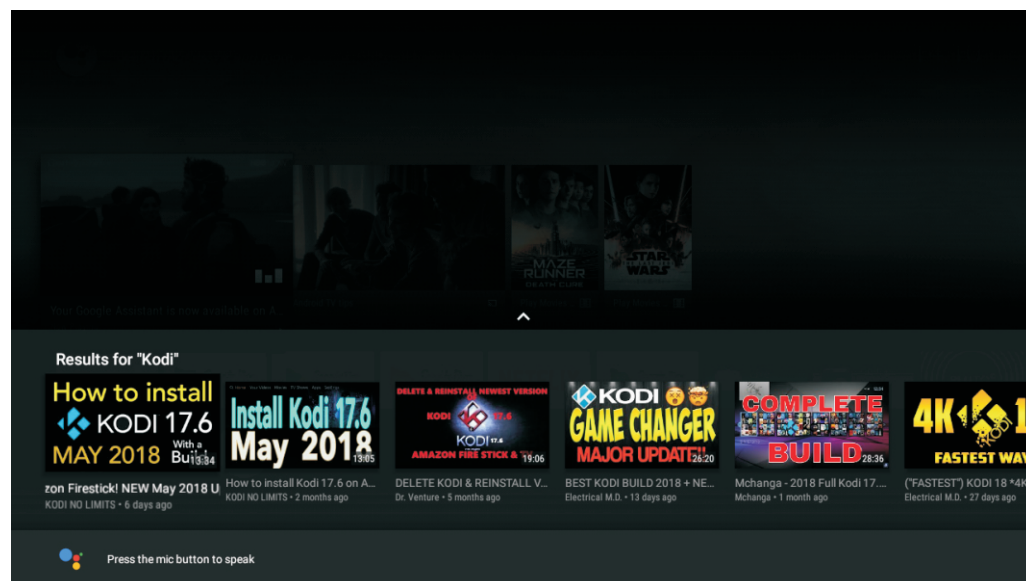

4.2 Preloaded Apps

In the second column, all preloaded Apps can be found. For example, Google Play Music & TV, YouTube, Play Store, Play Music, Netflix, Play Games, etc. Any of these Apps can be easily accessed via this section.

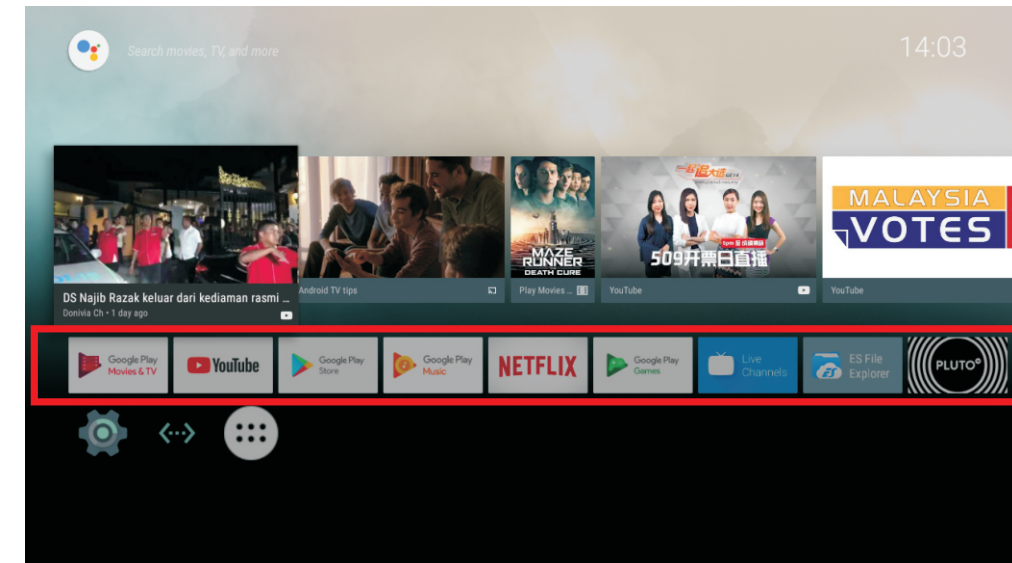

4.3 Settings, Internet status and the App drawer

Settings, Internet Status and the App Drawer can be found in the last column.

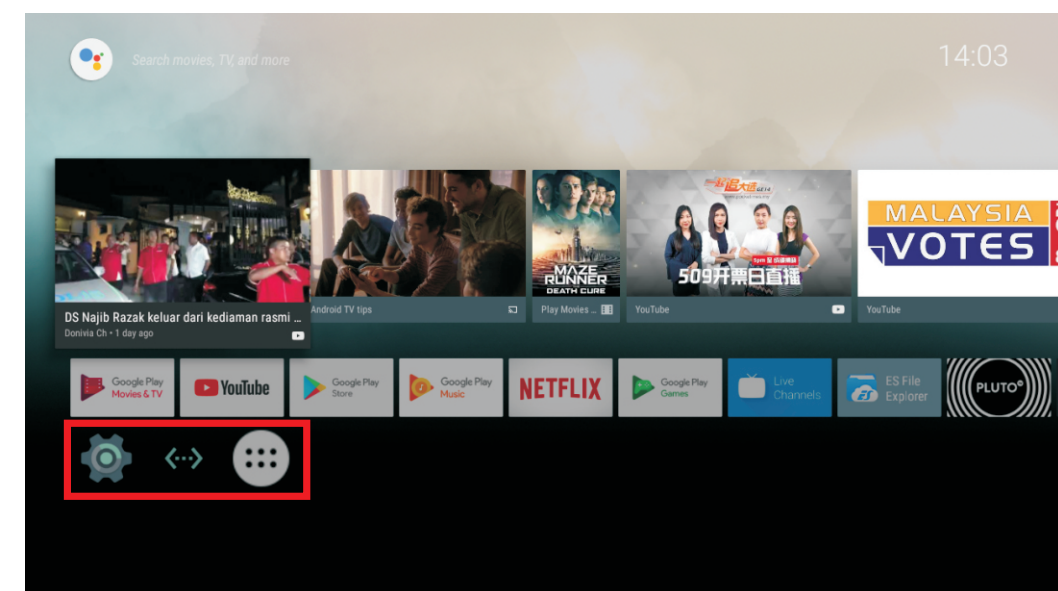

4.3.1 Device setting

WiFi and Ethernet details can be found under the Network section.

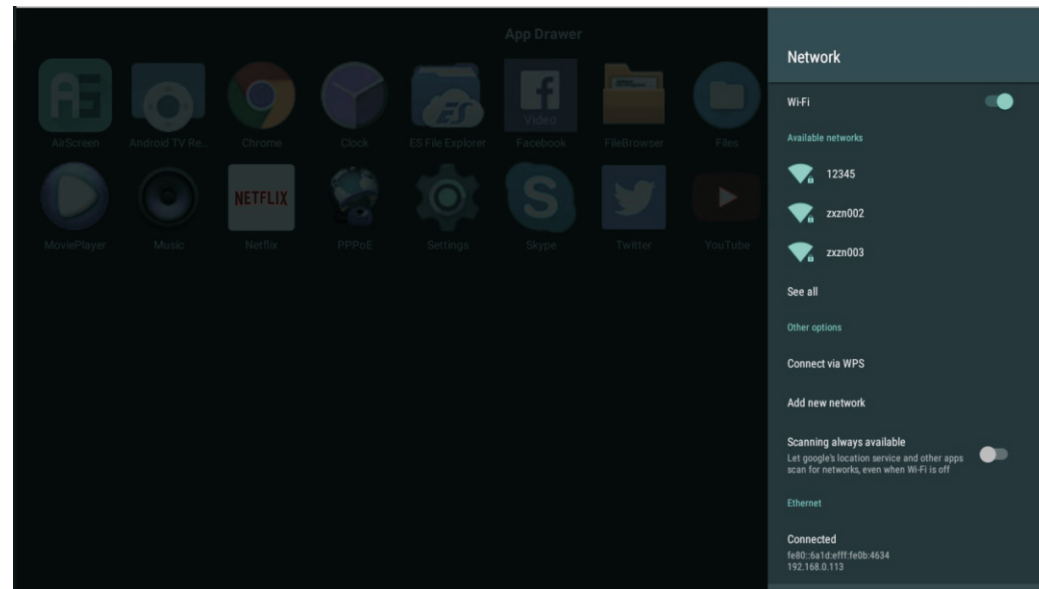

Sound: Set the sound of the system.

If you want to connect the TV box with your audio devices through SPDIF port, please set up the audio output first by go to setting-device setting-advanced setting-Sound-Dolby sound-RF and digital sound-SPDIF Raw

App: When selecting App, you will be able to view all Apps preloaded onto the box. Select the required App, and then you can either open it, force stop or unistall the App.

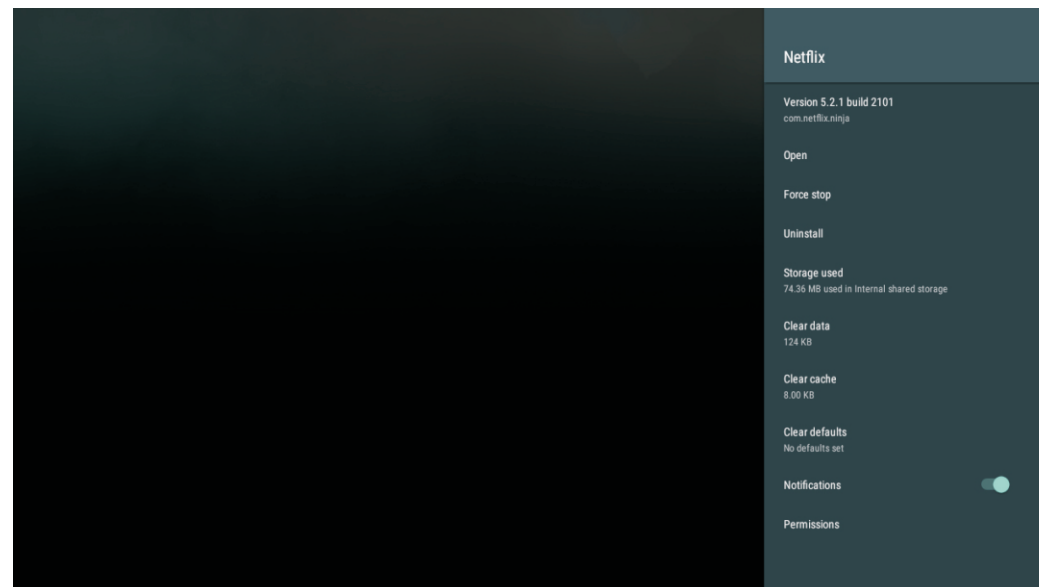

Screen Saver: Go to App Drawer and select "BurnKeyTool" App. Once a key is successfully burnt, reboot your device.

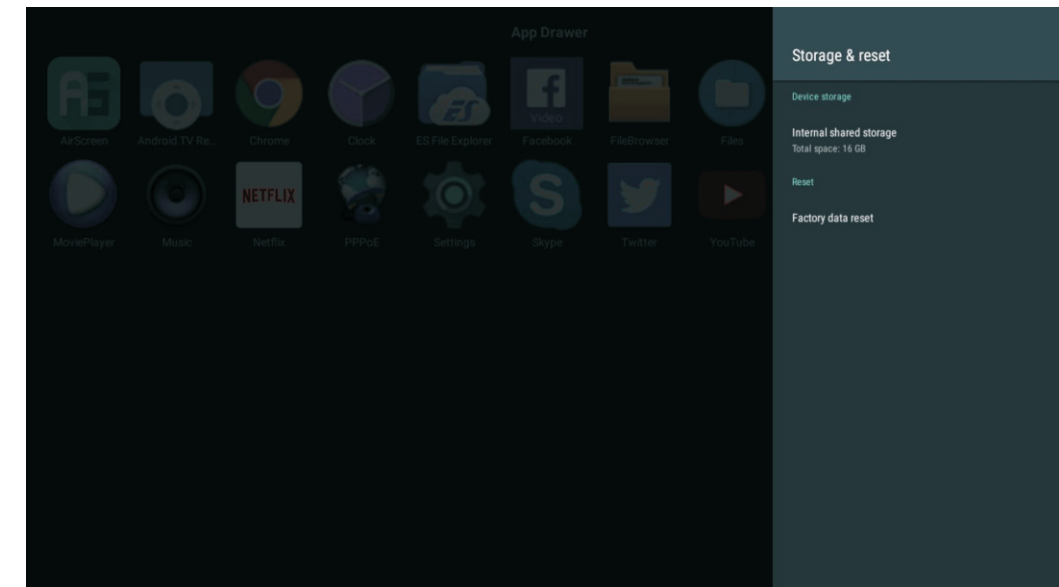

About: In this section, all information pertaining to your TV box can be found.

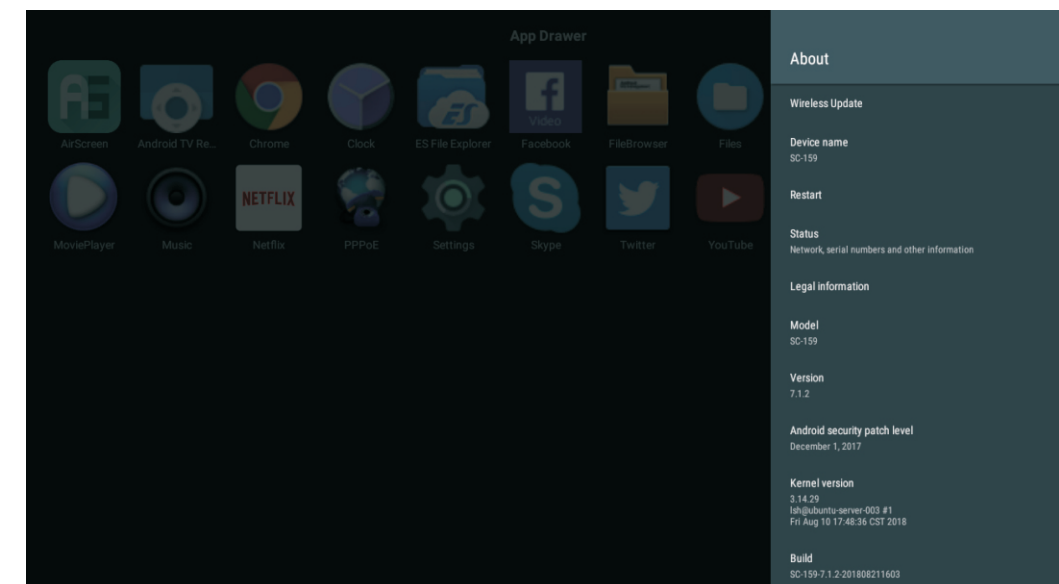

Advance Setting - Display - Screen Resolution: Select the correct screen resolution according to your TV.

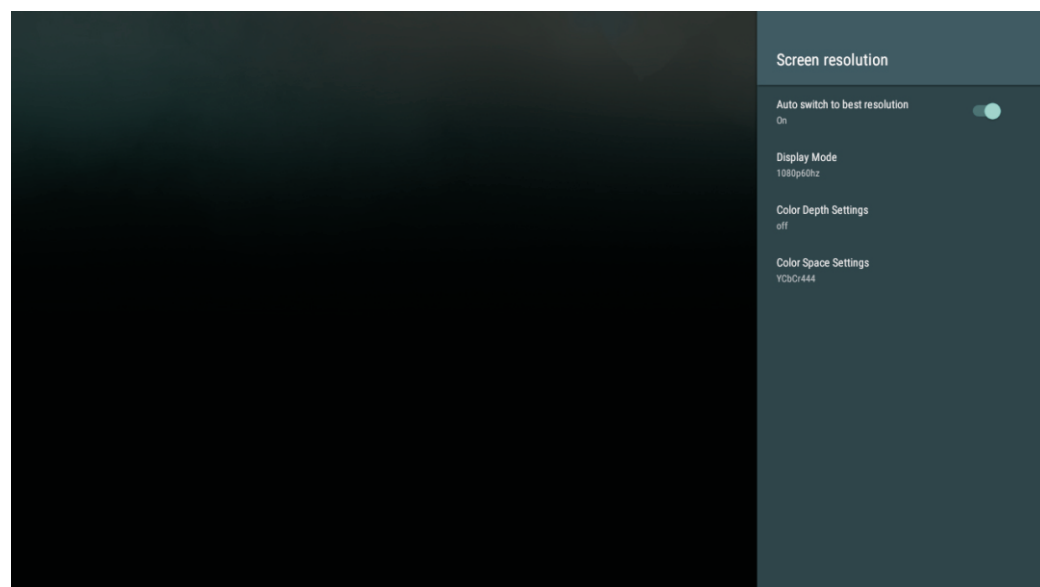

Advance Setting - Display - Screen Position: Zoom in / out of the screen.

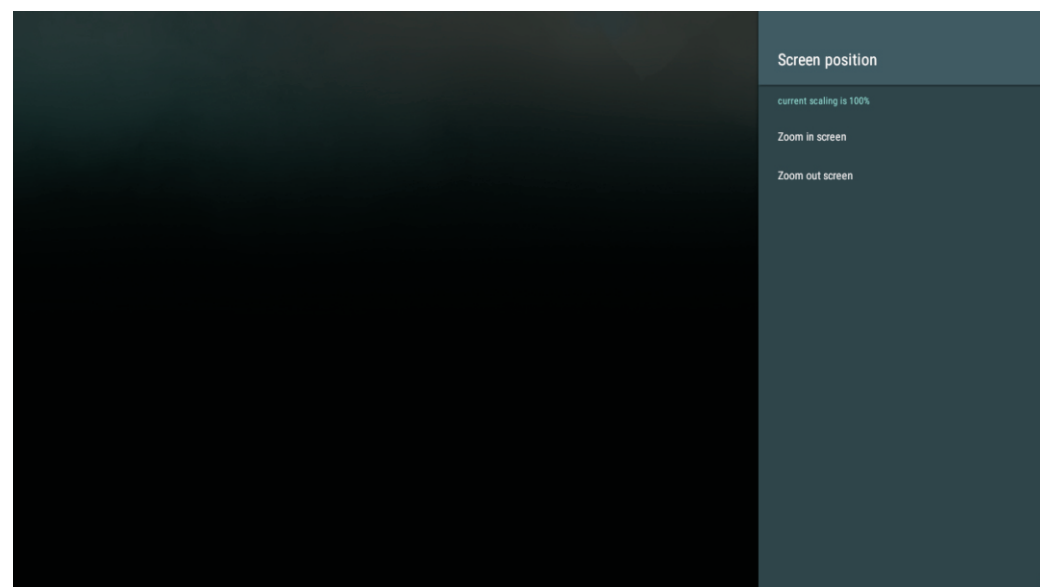

Advance Setting - More Setting: You will be redirected to the original android setting per below.

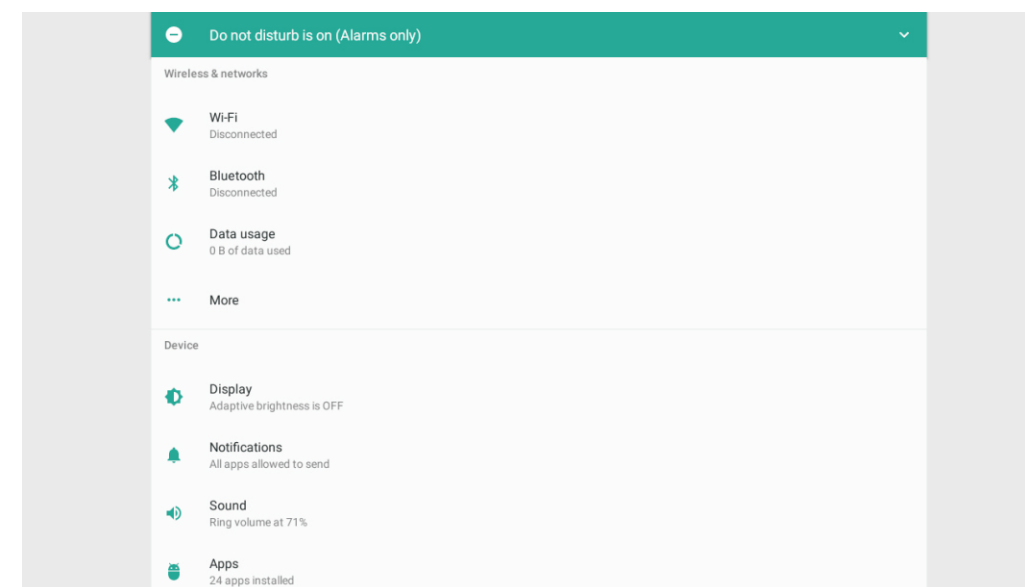

4.3.2 Preference setting

From this section, you can customize your preferred Date & Time, Language, Keyboard, Home Screen, Search, Speech and Accessibility settings.

4.3.3 Remote & accessories

You can add accessories through Bluetooth by clicking "Add Accessory", or you can unpair the remote by clicking the remote icon.

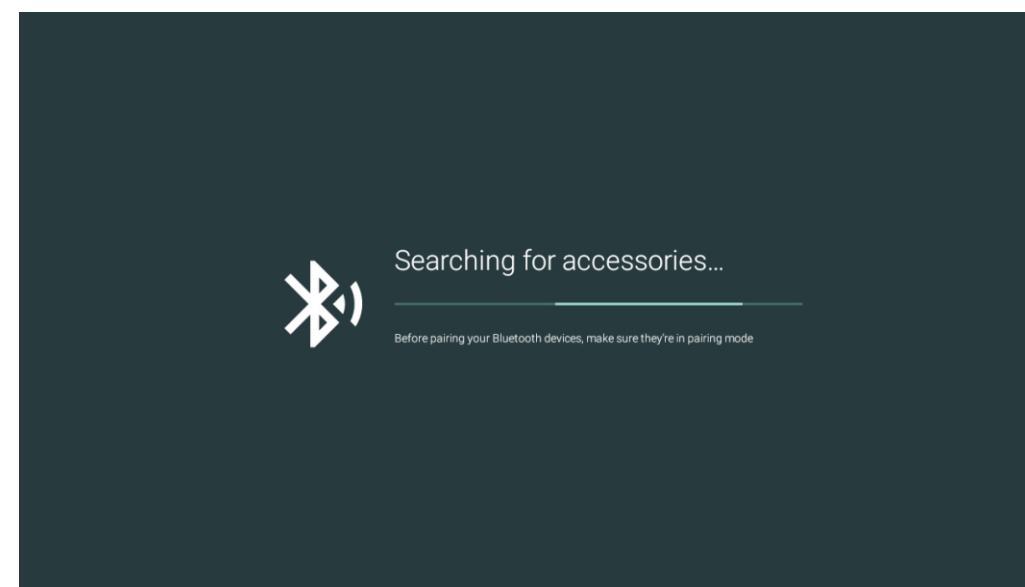

4.3.4 Personal setting

Location: Wi-Fi can be used to estimate location, alternatively, this can be disabled.
Security and restrictions: Allows installation of apps from sources other than the Play Store or you can disable this function.

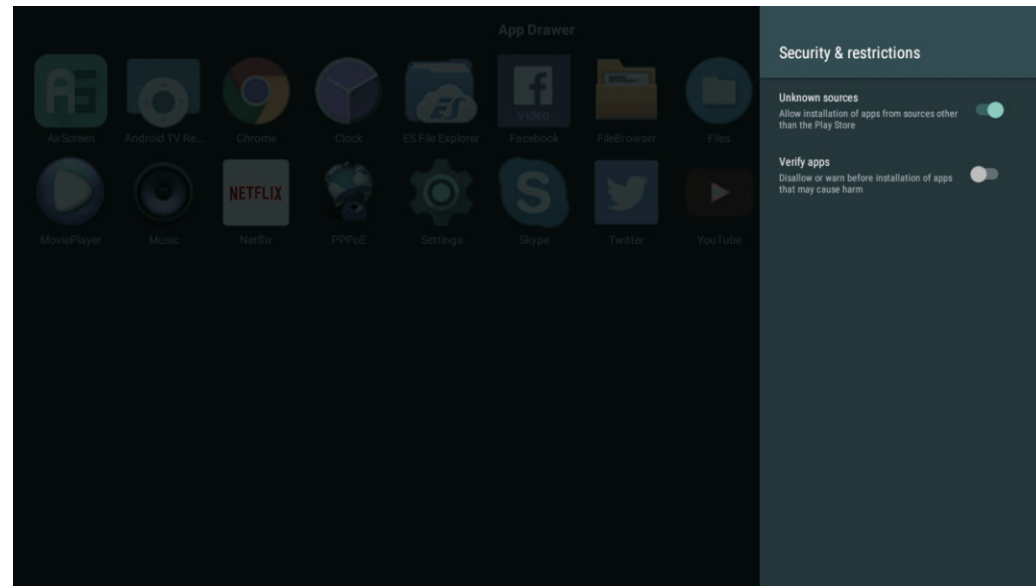

4.3.5 Accounts setting

Delete or add a Google account.

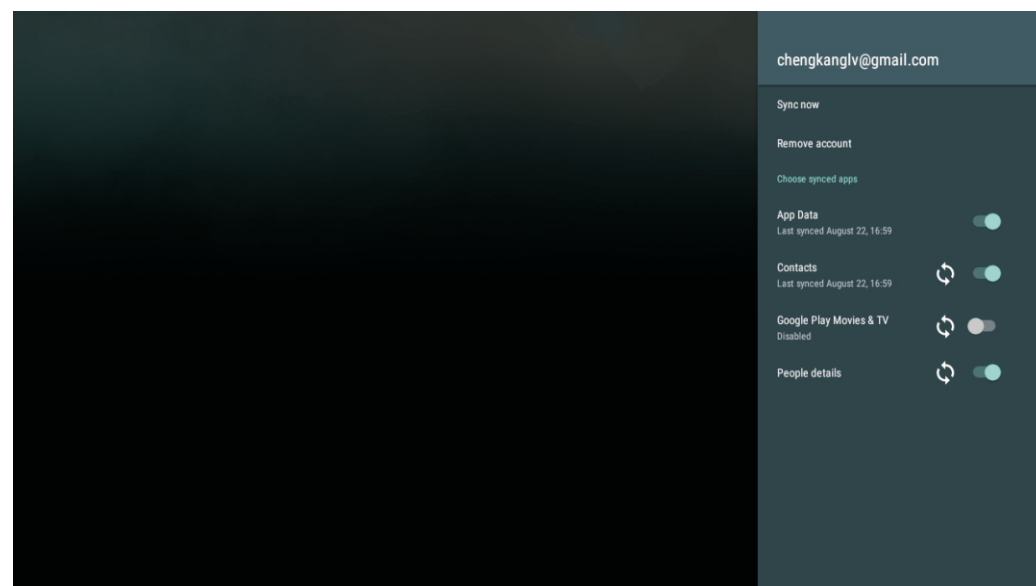

Manage all your accounts in this box.

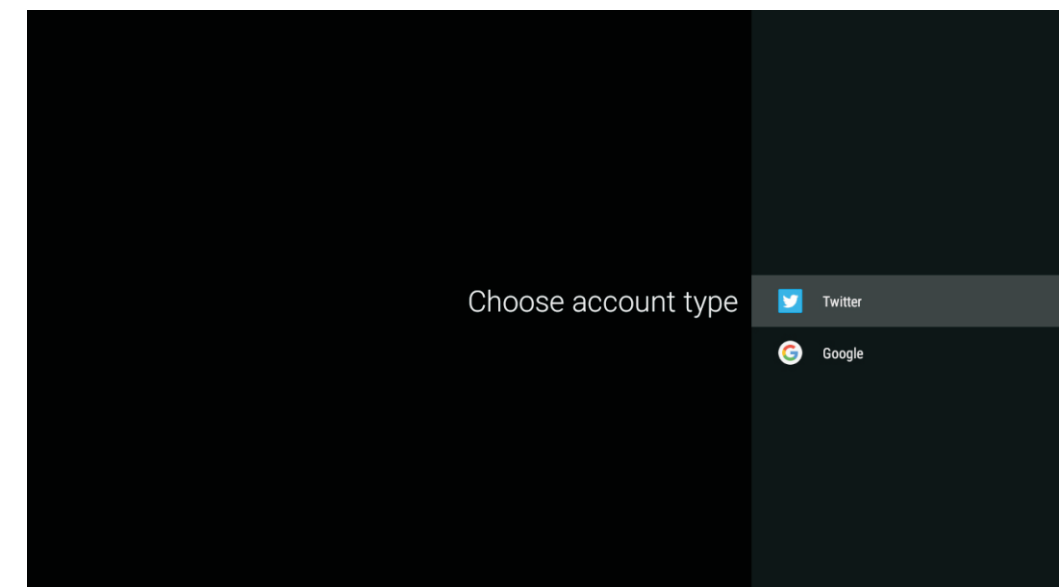

4.4 Internet status

By selecting the Network setting, Internet settings can also be selected and configured.

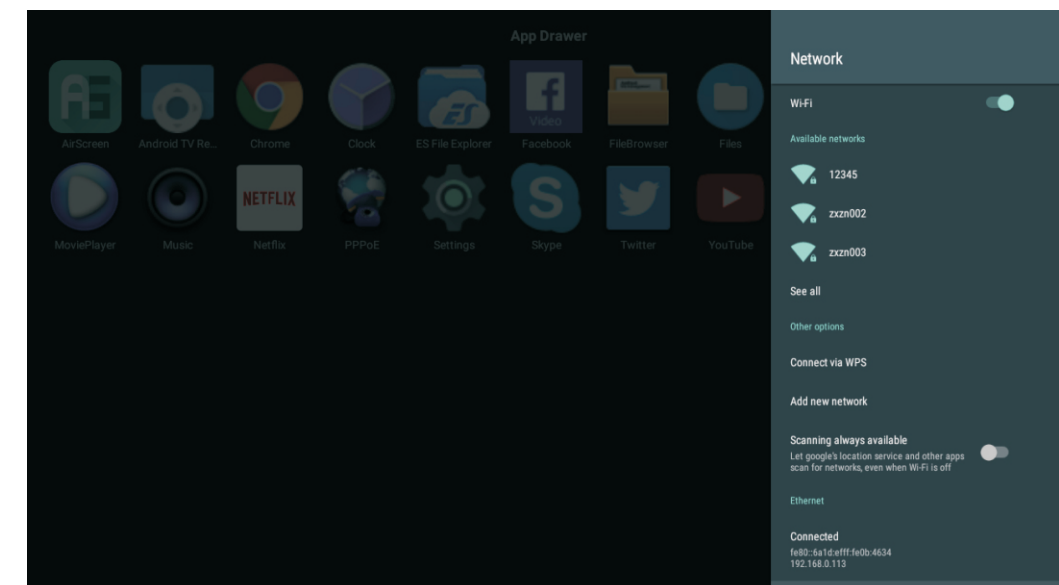

4.5 App Drawer

By clicking this icon, all Apps loaded onto the TV box can be viewed.

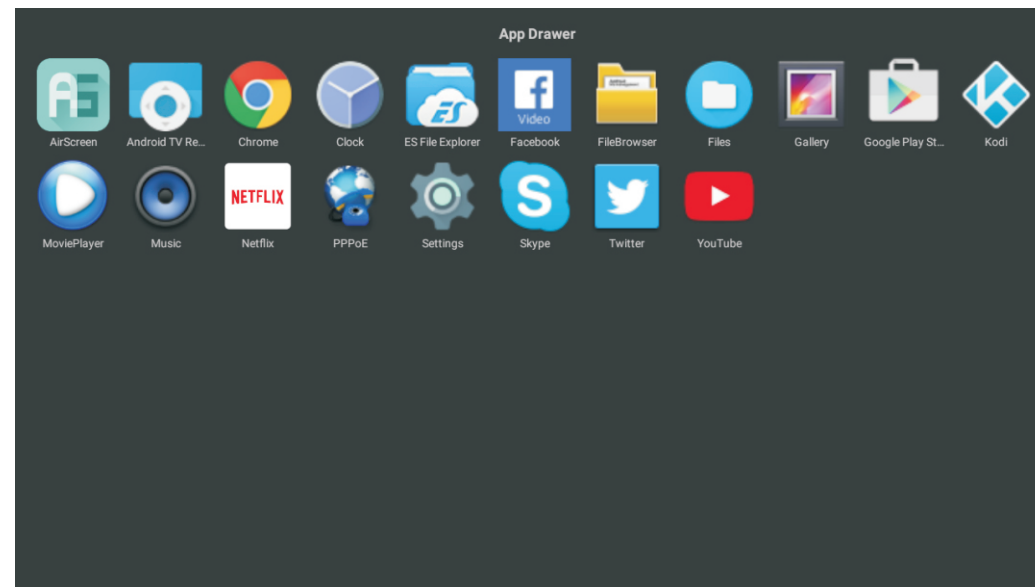

Chapter 5 - How to Install / Uninstall Apps

5.1 How to install Apps from the Play store or through an APK installer.

Open the “Play Store” and search for the Apps you want to install, then click “Install”.

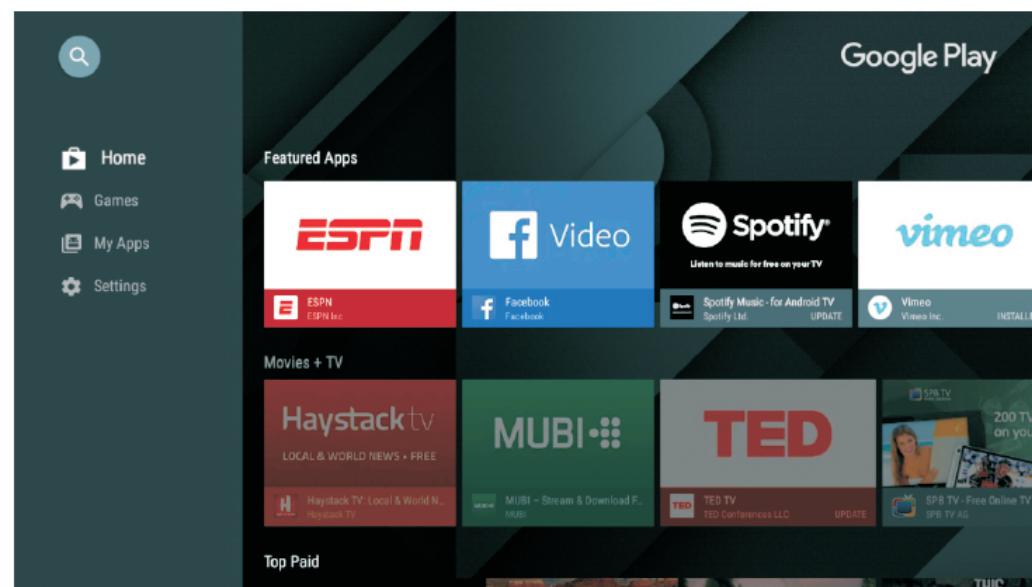

Alternatively, you can install Apps via a hard drive. Insert the external hard drive into the USB port of the Android box, it will be recognized immediately and ES File Explorer will pop up automatically. Press OK to enter and select the App you intend to install, then press OK and wait until the installation is complete.

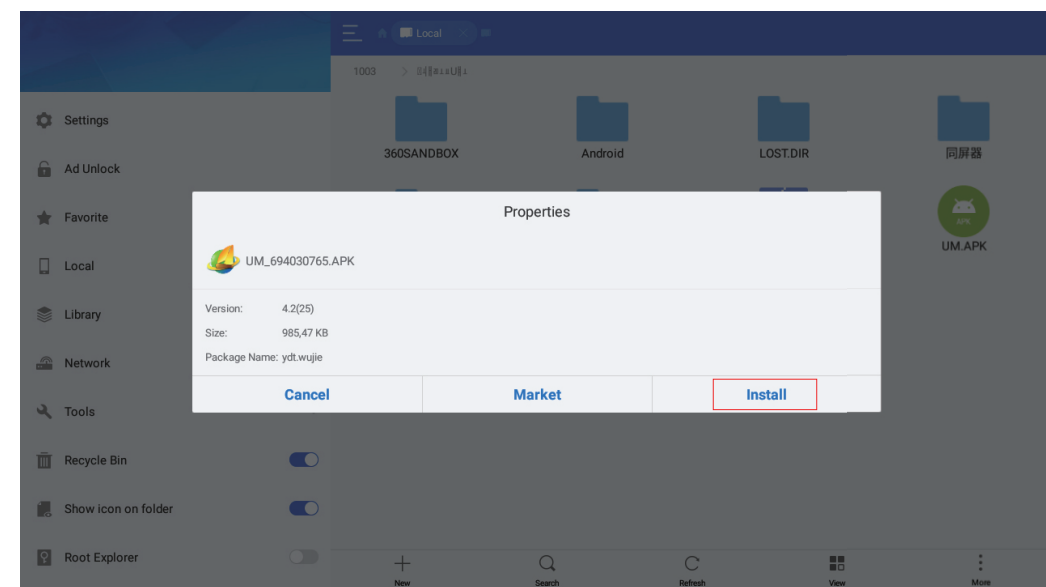
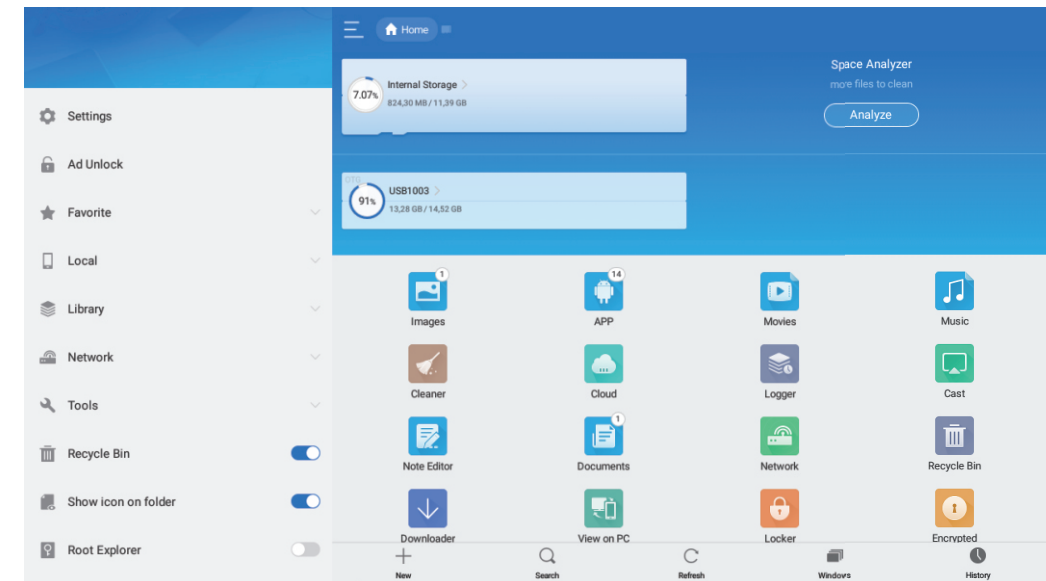

5.2 How to uninstall Apps

Open "Play Store"- "My apps", and you will be able to see all of the Apps you have installed. Click on the App you want to uninstall, then click on the "Uninstall" option.

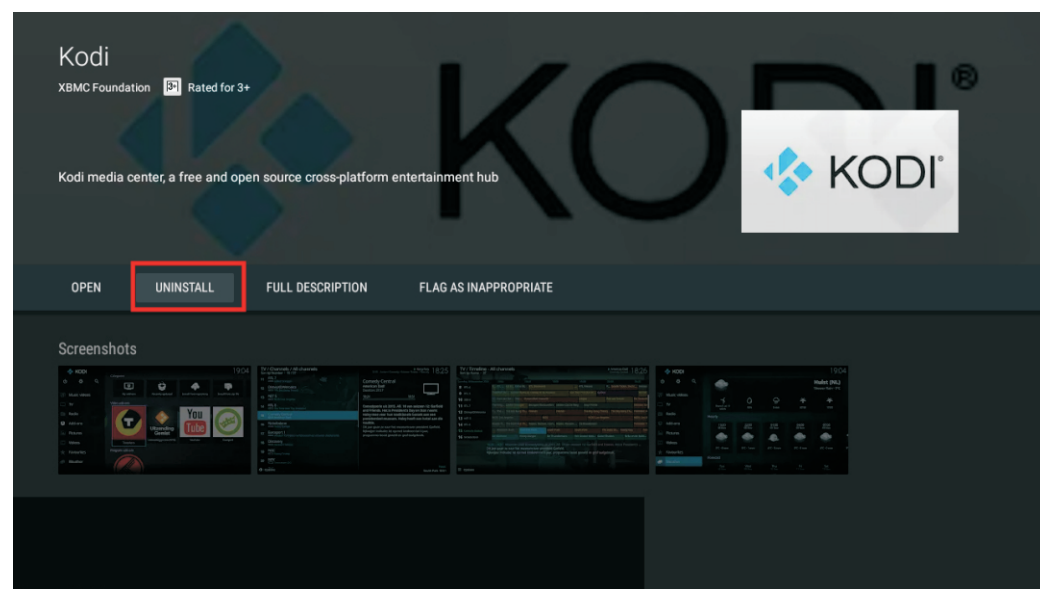

Chapter 6: Browse

Select Chrome from the App drawer to surf the Internet.

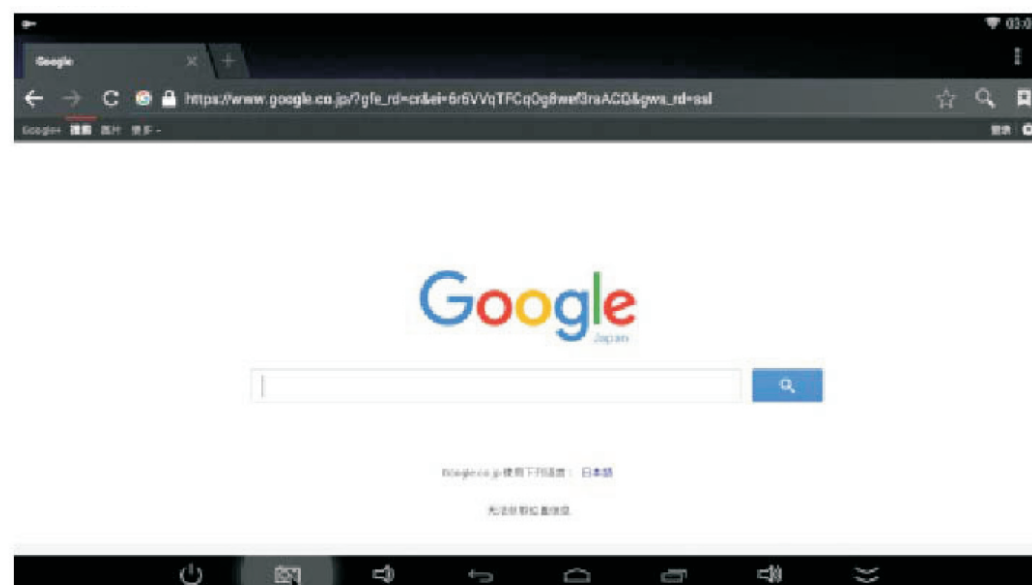

Chapter 7: How to manage your files - ES File Explorer

Select "ES File Explorer", click OK to enter, then you will be able to view and manage all files from here.

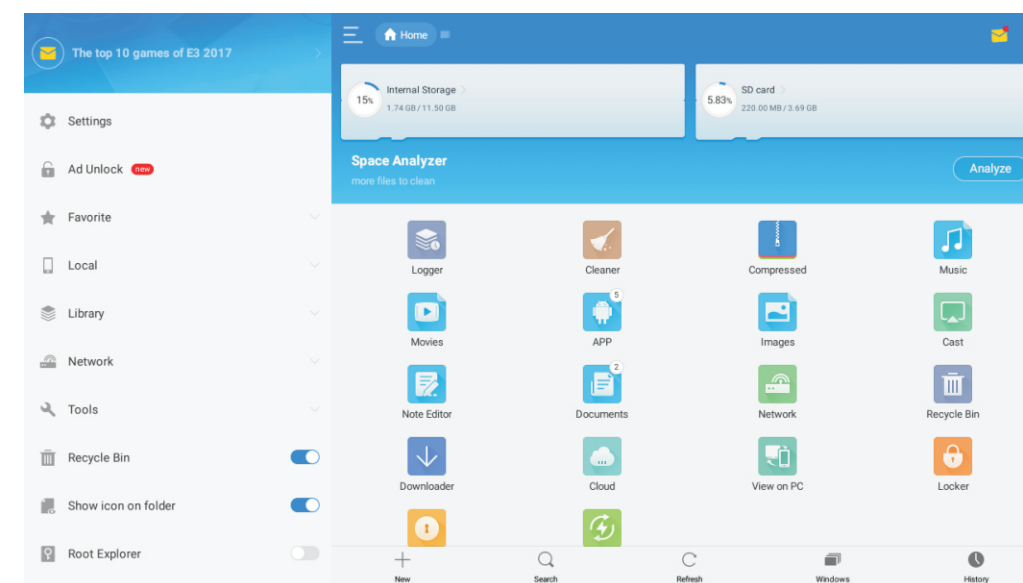

Chapter 8: Tips on pairing your remote

If the Bluetooth remote won't pair with your android TV box, try the troubleshooting steps below:

8.1 Connecting the TV box to a keyboard

Connect the Android TV box to a keyboard or mini wireless keyboard via the USB port. Press ESC key on the keyboard and enter into the system's initial boot interface (Please use the Up & Down arrows and Enter key on the keyboard to finish pairing).



8.2 Add accessory

Select Settings, then scroll down to select "Remote & Accessory". Select "Add Accessory" to search for Bluetooth devices.

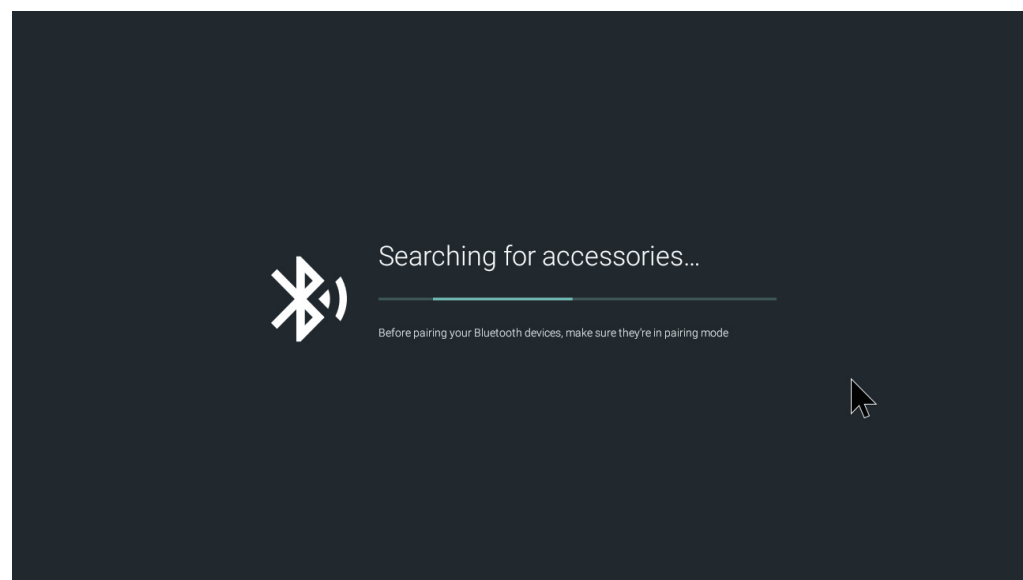
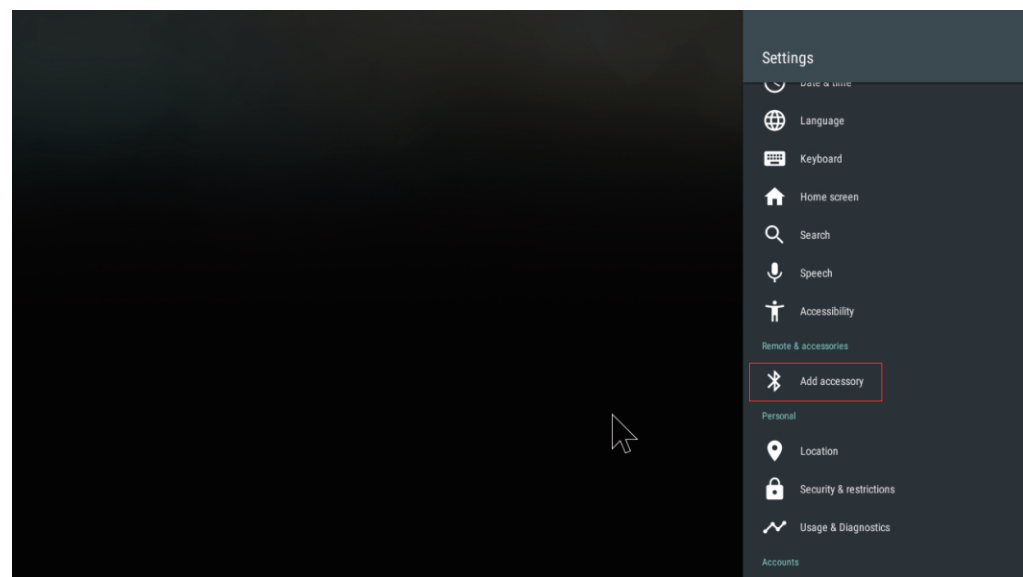

8.3 Activating pairing mode

To activate pairing mode, press and hold both the V- and PG- buttons on the remote for 5 to 10 seconds simultaneously.

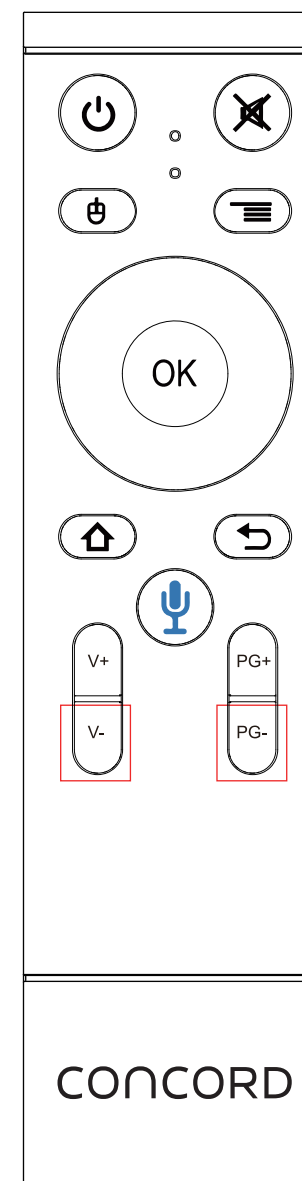

8.4 Pairing

The TV box will find the Bluetooth control device, then press **Enter** to start pairing.

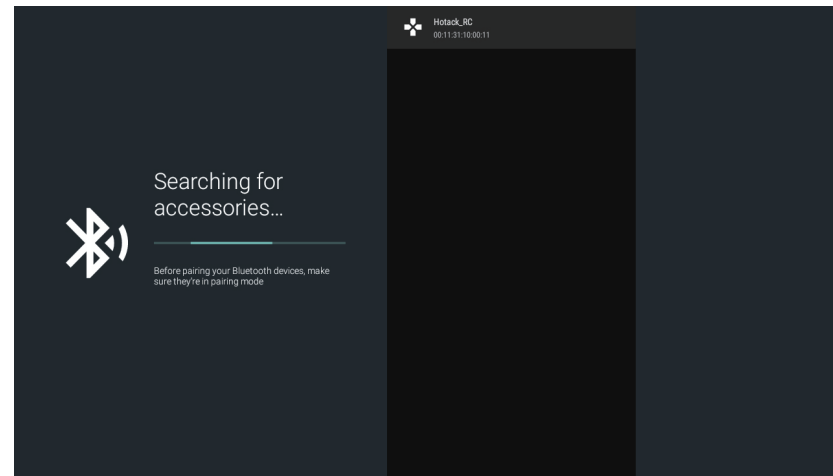

8.5 Pairing completed

Use the Bluetooth remote to navigate the box once pairing is successful.

Chapter 9: Troubleshooting

Problem	Solution
Netflix Error NW-6-404	<ul style="list-style-type: none">- Go to App Drawer and find the "BurnKeyTool" App and click yes. After burning a key successfully, reboot the device. This should solve the problem.
Other Netflix Error	<ul style="list-style-type: none">- Reboot the device.
No Power	<ul style="list-style-type: none">- Check if the power adaptor is properly connected to the power and the TV box .- Press the power on the remote control to turn on the power.
Blank Screen on Startup	<ul style="list-style-type: none">- Check that the power cable is not damaged and is securely attached to both the device and the power outlet- Check that the HDMI cable is not damaged and is securely attached to both the device and the TV.- Press the Source power button on your TV remote until you reach the source that your device is set to.
No Audio	<ul style="list-style-type: none">- Press the mute button on both the remote for the unit, and the remote for the TV.- Check that all cables are securely plugged in and are not damaged or bent.- Turn the unit off, wait 10 seconds and turn it back on again.- Try another set of audio cables.- Try another TV.
No Picture	<ul style="list-style-type: none">- Reconnect with HDMI cable or AV cable.- Check if the TV set is switched on.
Player does not respond to the remote control	<ul style="list-style-type: none">- Aim the remote control directly at the sensor on the front of the TV box.- Reduce the distance to the TV box .- Replace the batteries in the remote control .

The contents of the USB flash drive can't be read	<ul style="list-style-type: none"> - The USB flash drive format is not compatible with the box - If one of the USB's is not ready, please turn off the TV box for 30 seconds and reboot the TV box.
The TV screen is black and the player's LED indicator is blinking	<ul style="list-style-type: none"> - Turn off your TV box, wait 30 seconds, turn it on again. - If under HDMI status, check if HDMI connection is correct or change the HDMI cable, set the HDMI output of this TV box to 720P.
Apps that constantly crash/stop working	<ul style="list-style-type: none"> - Uninstall the App. - Reinstall the App from the Play Store App.

Chapter 10: Specification

Product Specification

Product short description: Android TV box with Google assistant

CPU: Amlogic S905X

Main Frequency : Processor-Quad core cortex A53 @Up to 2.0GHz

GPU : Penta core ARM Mali 450

Memory : 2GB DDR3,16GB eMMC flash

Operating system : Android 7.1 Nougat

Internet Solution : Wifi: 802.11 b/g /n, 10/100 Ethernet

Support 4K : 10-bit H.265/H.264/VP9 video playback and display

Copyright and Trademark Notices

- Wi-Fi is a registered mark of the Wi-Fi Alliance.
- Android, Google Play and other marks are trademarks of Google Inc.
- Screenshots and product images are simulated and for instructional purposes only.
- They may differ from the actual product and are subject to change without notice.
- Content shown may vary from actual available content, which may change without notice.