

digitech

WiFi

Digital Weather Station

with 4 Day Forecasting



Model:
XC0450

User Manual

TABLE OF CONTENTS

1.	INTRODUCTION	4
1.1	QUICK START GUIDE	5
2.	PRE INSTALLATION	5
2.1	CHECKOUT	5
2.2	SITE SELECTION	5
3.	GETTING STARTED	6
3.1	WIRELESS 7-IN-1 SENSOR	6
3.1.1	INSTALL WIND VANE	6
3.1.2	INSTALL RAIN GAUGE FUNNEL	7
3.1.3	INSTALL BATTERIES	7
3.1.4	INSTALL MOUNTING POLE	7
3.1.5	DIRECTION ALIGNMENT	8
3.1.6	POINTING THE WIRELESS 7-IN-1 SENSOR TO SOUTH	8
3.1.7	PAIRING THE WIRELESS SENSORS WITH THE CONSOLE	8
3.2	SYNCHRONIZING ADDITIONAL SENSOR(S) (OPTIONAL)	8
3.3	RECOMMENDATION FOR BEST WIRELESS COMMUNICATION	9
3.4	SETUP THE CONSOLE	10
3.4.1	POWER UP THE DISPLAY CONSOLE	10
3.4.2	SETUP DISPLAY CONSOLE	11
3.4.3	SYNCHRONIZING WIRELESS 7-IN-1 SENSOR	11
3.4.4	DATA CLEARING	11
3.5	TABLE STAND INSTALLATION	11
4.	DISPLAY CONSOLE FUNCTIONS AND OPERATION	12
4.1	SCREEN DISPLAY	12
4.2	DISPLAY CONSOLE KEYS	12
4.3	CONSOLE FEATURES	13
4.3.1	MULTI-DAY WEATHER FORECAST FOR TODAY & NEXT 3 DAY	13
4.3.2	HIGH / LOW TEMPERATURE FORECAST FOR TODAY & NEXT 3 DAYS	14
4.3.3	AVERAGE TEMPERATURE FORECAST WITH CHANCE OF RAIN FOR TODAY & NEXT 3 DAYS	14
4.3.4	OUTDOOR TEMPERATURE, HUMIDITY & TEMPERATURE INDEX	15
4.3.5	INDOOR / CHANNELS TEMPERATURE & HUMIDITY	16
4.3.6	MULTI-CHANNEL AND SCROLL MODE FOR OPTIONAL SENSORS	16
4.3.7	WATER LEAK (OPTIONAL LEAK SENSOR)	17
4.3.8	WIND	17
4.3.9	BAROMETRIC PRESSURE	19
4.3.10	RAIN	19
4.3.11	LIGHT INTENSITY, UV INDEX & SUNBURN TIME	20
4.3.12	MAXIMUM / MINIMUM RECORDS	20
4.3.13	MOON PHASE	21
4.3.14	WIRELESS SENSOR SIGNAL RECEIVING	21
4.3.15	TIME SYNCHRONIZE STATUS	21
4.3.16	WI-FI CONNECTION STATUS	21
4.4	OTHER SETTING	22
4.4.1	TIME, DATE AND GENERAL SETTING	22
4.4.2	SETTING ALARM TIME	22
4.4.3	UNIT SETTING	23
4.4.4	BACK LIGHT	23
5.	CREATE PWL ACCOUNT & SETUP WI-FI CONNECTION OF CONSOLE	23
5.1	CREATE PWL ACCOUNT AND ADD NEW DEVICE IN PWL	23
6.	CONNECT CONSOLE TO WI-FI	25
6.1	CONSOLE IN ACCESS POINT MODE	25
6.2	CONNECT TO THE CONSOLE	25
6.3	SETUP THE WEATHER SERVER CONNECTION	26
6.4	ADVANCE SETTING IN WEB INTERFACE	27
6.4.1	CALIBRATION	28

7. PROWEATHERLIVE (PWL) LIVE DATA & OPERATION	28
7.1 VIEW LIVE DATA	28
7.2 UPLOAD TO OTHER WEATHER SERVERS	28
8. MAINTENANCE	29
8.1 FIRMWARE UPDATE	29
8.1.1 FIRMWARE UPDATE STEP	29
8.2 BATTERY REPLACEMENT	29
8.2.1 RE-PAIRING THE SENSOR(S) MANUALLY	30
8.3 RESET AND FACTORY RESET	30
8.4 WIRELESS 7-IN-1 SENSOR ARRAY MAINTENANCE	30
9. TROUBLESHOOT	31
10. SPECIFICATIONS	32
10.1 CONSOLE	32
10.2 WIRELESS 7-IN-1 SENSOR	34

ABOUT THIS USER'S MANUAL



This symbol represents a warning. To ensure safe use, always adhere to the instructions described in this documentation.



This symbol is followed by a user's tip.



PRECAUTIONS



- Keeping and reading the "User manual" is highly recommended. The manufacturer and supplier cannot accept any responsibility for any incorrect readings, export data lost and any consequences that occur should an inaccurate reading take place.
- Images shown in this manual may differ from the actual display.
- The contents of this manual may not be reproduced without the permission of the manufacturer.
- Technical specifications and user manual contents for this product are subject to change without notice.
- This product is not to be used for medical purposes or for public information
- Do not subject the unit to excessive force, shock, dust, temperature or humidity.
- Do not cover the ventilation holes with any items such as newspapers, curtains etc.
- Do not immerse the unit in water. If you spill liquid over it, dry it immediately with a soft, lint-free cloth.
- Do not clean the unit with abrasive or corrosive materials.
- Do not tamper with the unit's internal components. This invalidates the warranty.
- Placement of this product on certain types of wood may result in damage to its finishing for which manufacturer will not be responsible. Consult the furniture manufacturer's care instructions for information.
- Only use attachments / accessories specified by the manufacturer.
- This product is not a toy. Keep out of the reach of children.
- The console is intended to be used only indoors.
- Place the console at least 20cm from nearby persons.
- Console working temperature: -5°C ~ 50°C

WARNING

- Do not ingest the battery. Chemical Burn Hazard.
- This product contains a coin/button cell battery. If the coin/button cell battery is swallowed, it can cause severe internal burns in just 2 hours and can lead to death.
- Keep new and used batteries apart. If battery door does not close securely, stop using the product and keep it away from children.
- If you think batteries might have been swallowed or placed inside any part of the body, seek immediate medical attention.
- An appliance is only suitable for mounting at height ≤ 2m. (Equipment mass ≤1kg)
- This product is intended for use only with the adaptor provided.
- This device is only suitable for mounting at height < 2m.
- When disposing of this product, ensure it is collected separately for special treatment.
- The AC/DC adaptor is used as disconnect device.

- The AC/DC adaptor of apparatus should not be obstructed OR should be easily accessed during intended used.
- To be completely disconnect the power input, the AC/DC adaptor of apparatus shall be disconnected from the mains.

CAUTION

- Danger of explosion if battery is incorrectly replaced. Replace only with the same or equivalent type.
- Battery cannot be subjected to high or low extreme temperatures, low air pressure at high altitude during use, storage or transportation.
- Replacement of a battery with an incorrect type can result in an explosion or the leakage of flammable liquid or gas.
- Disposal of a battery into fire or a hot oven, or mechanically crushing or cutting of a battery, can result in an explosion.
- Leaving a battery in an extremely high temperature surrounding environment can result in an explosion or the leakage of flammable liquid or gas.
- A battery subjected to extremely low air pressure may result in an explosion or the leakage of flammable liquid or gas.

1. INTRODUCTION

Thank you for your purchase of 4-Day Forecast WI-FI Weather Station. This system gathers many advance features for weather observer, such as ProWeatherLive (PWL) cloud service which provide online weather forecast and condition of your area onto your console while at the same time receiving your personal weather data upload to be viewed on PWL website or PWL App anytime. The 7-in-1 professional wireless sensor-array integrates temperature, humidity, wind, rain, UV and light sensors together, to continually monitoring your local weather conditions at all time and transmit these data to your console through wireless radio frequency technology. This system also support up to 7 thermo-hygro sensor(s) and other advance optional sensor(s) such as water leak sensors that also allow you to monitor all your environment condition in one system, one app.

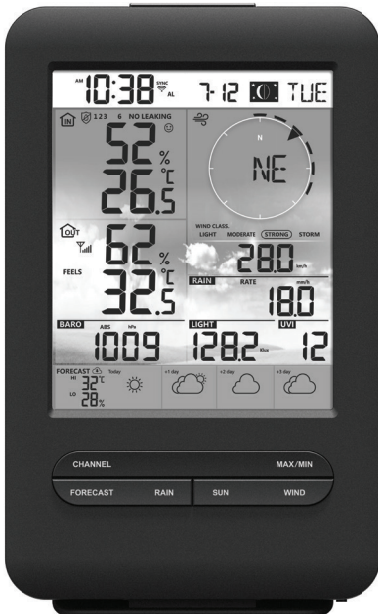

WARNING – KEEP BUTTON BATTERIES OUT OF REACH OF CHILDREN

- If swallowed a lithium button battery may lead to serious or fatal injury in as little as 2 hours, due to chemical burns and potential perforation of the oesophagus
- All button batteries must be kept away from children regardless if they are new or used.
- If you suspect your child has swallowed or inserted a button battery immediately call the 24-hour Poisons Information Centre on 13 11 26 (Australia) or 0800 764 766 (New Zealand) for fast, expert advice.
- If your child is having difficulty breathing contact 000 (Australia) or 111 (New Zealand).
- Dispose of used button batteries immediately and safely out of the reach of children. A battery can still be dangerous even when it can no longer operate the device.
- As soon as you have finished using a button battery, put sticky tape around both sides of it. This will make it harder for children to swallow the button battery and avoid the risk of the battery catching fire.
- Immediately dispose of button batteries immediately out of reach of children, or recycle using a child resistant container and take used cells to your local battery collection centre.

1.1 QUICK START GUIDE

The following Quick Start Guide provides the necessary steps to install and operate the weather station, and upload to the Internet, along with references to the pertinent sections.

Step	Description	Section
1	Power up the 7-in-1 sensor array	3.1.3
2	Power up the display console and pair with sensor array	3.4
3	Manually set date and time (This part is unnecessary if the weather station is connected to PWL later)	4.4.1
4	Reset the rain to zero	4.3.10.2
5	Create account and register weather station at PWL	5
6	Connect weather station to WiFi	6.1, 6.2, 6.3

2. PRE INSTALLATION

2.1 CHECKOUT

Before permanently install your weather station, we recommend the user to operate the weather station at a location which is easy to access to. This will allow you to get familiar with the weather station functions and calibration procedures, to ensure proper operation before installing it permanently.

2.2 SITE SELECTION

Before installing the sensor array, please consider the followings;

1. Rain gauge must be clean every few months
2. Batteries must be changed every 2 to 2.5 years
3. Avoid radiant heat reflected from any adjacent buildings and structures. Ideally, the sensor array should be installed at 1.5m (5') from any building, structure, ground or roof top.
4. Choose an area of open space in direct sunlight without any obstruction of rain, wind, and sunlight.
5. Transmission range between sensor array and display console could reach a distance of 150m (or 450 feet) at line of sight, providing there are no interfering obstacles in between or nearby such as trees, towers, or high voltage line. Check the reception signal quality to ensure good reception.
6. Household appliance such as fridge, lighting, dimmers may pose Electro-magnetic interference (EMI), while Radio Frequency Interference (RFI) from devices operating in the same frequency range may cause signal intermittent. Choose a location at least 1-2 meter (3-5 feet) away from these interference sources to ensure best reception.

3. GETTING STARTED

3.1 WIRELESS 7-IN-1 SENSOR

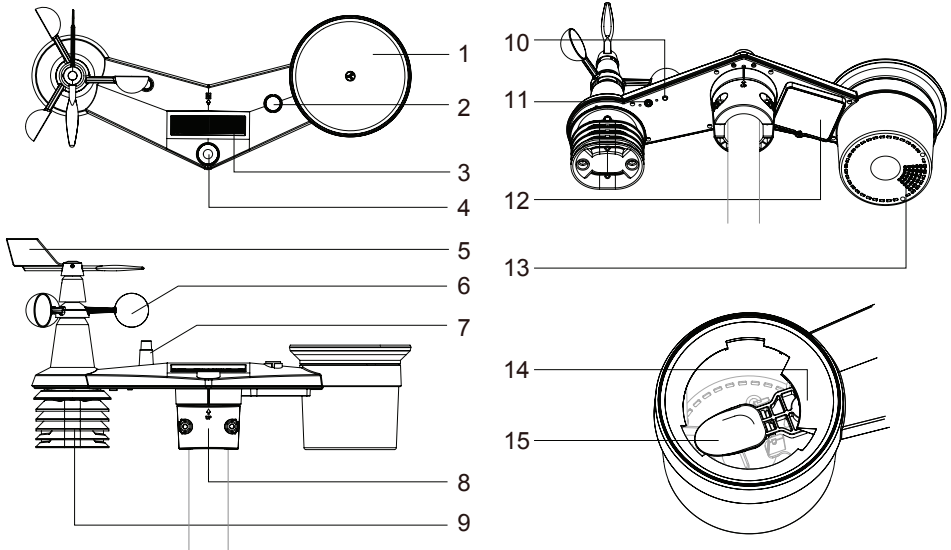

- 1. Rain collector
- 2. Balance indicator
- 3. Solar panel
- 4. UVI / light sensor
- 5. Wind vane
- 6. Wind cups
- 7. Antenna
- 8. Mounting clamp
- 9. Radiation shield and thermo-hygro sensor
- 10. Red LED indicator
- 11. [RESET] key
- 12. Battery door
- 13. Drain holes
- 14. Rain sensor
- 15. Tipping bucket

3.1.1 INSTALL WIND VANE

With reference to photo below, (a) locate and align the flat are on the wind vane shaft to the flat surface on the wind vane and push the vane onto the shaft. (b) tighten the set screw with a precision screwdriver.

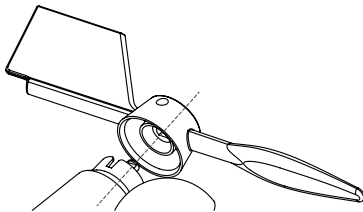

Step 1

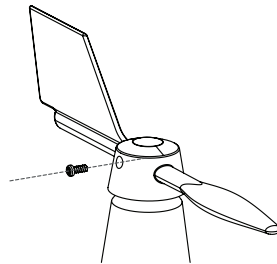

Step 2

3.1.2 INSTALL RAIN GAUGE FUNNEL

Install the rain gauge funnel and rotate clockwise to lock the funnel to the sensor array

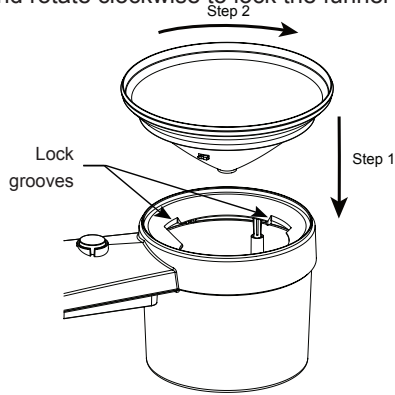

3.1.3 INSTALL BATTERIES

Unscrew the battery door at bottom of unit. Insert the 3 AA batteries (non-rechargeable) according to the +/- polarity indicated. The red LED indicator on the back of the sensor array will turn on, and then begin flashing every 12 seconds.

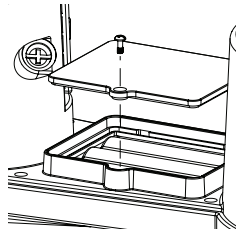

NOTE:

We recommend using non-rechargeable Lithium AA batteries for cold weather climate, but normally Alkaline batteries are sufficient for use in most weather condition.

3.1.4 INSTALL MOUNTING POLE

1. Stick the 2 rubber pads (provided) onto the inner sides of the mounting part
2. Insert the 2 screws into the sensor array mounting base and hand tighten the screws
3. Place the sensor array over the mounting pole and align the sensor array to North direction
4. Tighten the screws to fit the size of your mounting pole

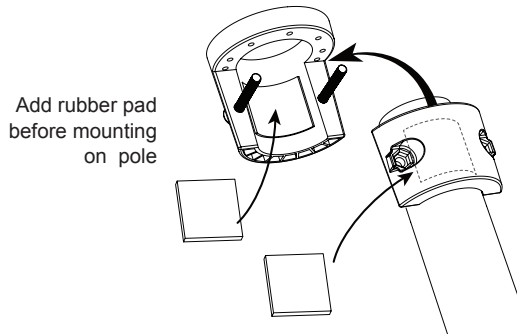

NOTE:

- Any metal object can attract lightning strikes, including your sensor-array mounting pole. Never install sensor-array in stormy days.
- If you want to install a sensor-array on a house or building, consult a licensed electrical engineer to ensure proper grounding. Direct lightning impact on a metal pole can damage or destroy your home.
- Installing the sensor at high location may result in personal injury or death. Perform as many initial inspections and operations as possible on the ground and in buildings or houses. Only install the sensor-array on clear, dry days.

3.1.5 DIRECTION ALIGNMENT

 Install the wireless 7-in-1 sensor in an open location with no obstructions above and around the sensor for accurate rain and wind measurement.

Locate the North (N) marker on top of the 7-in-1 sensor and align the marker to point North upon final installation with a compass or GPS. Tighten the mounting bracket around a 30 to 40 mm diameter pole (not included) using two screw and nuts provided.

Use the bubble level on the 7-in-1 sensor to make sure the sensor is completely level for proper measurement of rainfall, UV and light intensity.

3.1.6 POINTING THE WIRELESS 7-IN-1 SENSOR TO SOUTH

The outdoor 7-IN-1 sensor is calibrated to point to North for the maximum accuracy. However, for the user's convenience (e.g. users in the Southern hemisphere), it is possible to use the sensor with the wind vane pointing to South.

1. Install the 7-IN-1 wireless sensor with its wind meter end pointing to South. (Please refer to **section 3.1.4** for mounting details)
2. Select "S" in hemisphere section of the setup UI setup page. (Please refer to **section 6.3** for setup details)
3. Press  icon to confirm and exit.

 NOTE: Changing the hemisphere setting will automatically switch the direction of the moon phase on the display.

3.1.7 PAIRING THE WIRELESS SENSORS WITH THE CONSOLE



The console will automatically search and connect to your wireless sensor(s). Once your sensor(s) pair up successful, the sensor(s) signal strength indication and weather. information will appear on your console display.

 NOTE: Every reading transmission, the symbol of signal transmission,  will flash at once.

3.2 SYNCHRONIZING ADDITIONAL SENSOR(S) (OPTIONAL)

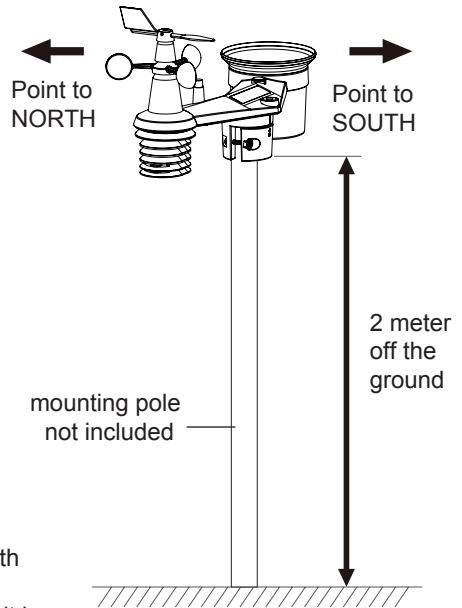
This console can display the data from additional sensors and upload to ProWeatherLive (PWL) cloud server for user to view the data in PWL website and App. Please contact your local retailer for details of difference sensors. Some of these sensors are multi-channel. Before inserting the batteries, set the channel number if channel slide switch is located at back of sensors (inside battery compartment). For their operations please refer to the manuals that come with the products.

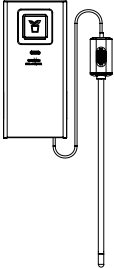
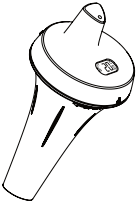
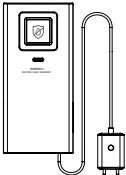

Model	No of channel	Description	Image
C3130A	Up to 7 sensors	Thermo-Hygrometer sensor	
C3133A		High Precision Thermo-Hygrometer sensor	
C3127A		Soil Moisture and Temperature Sensor	
C3107B		Pool Sensor	
C3128A		Water leak sensor	

3.3 RECOMMENDATION FOR BEST WIRELESS COMMUNICATION

Effective wireless communication is susceptible to noise interference in the environment, and distance and barriers between the sensor transmitter and the display console.

1. Electromagnetic interference (EMI) – these may be generated by machinery, appliances, lighting, dimmers and computers, etc. So please keep your display console 1 or 2 meters away from these items.
2. Radio-frequency interference (RFI) – if you have other devices operating on 868 / 915 / 917 MHz, you might experience communication intermittent. Please re-located your transmitter or display console to avoid signal intermittent problem.
3. Distance. Path loss occurs naturally with distance. This device is rated to 150m (450 feet) by line of sight (in interference free environment and without barriers). However, typically you will get 30m (100 feet) maximum in real life installation, which includes passing through barriers.

- Barriers. Radio signal are blocked by metal barriers such as aluminum cladding. Please align the sensor array and display console to get them in clear line of sight through window if you have metal cladding.

The table below show a typical level of reduction in signal strength each time the signal passed through these building materials

Materials	Signal strength reduction
Glass (untreated)	10 ~ 20%
Wood	10 ~ 30%
Plasterboard / drywall	20 ~ 40%
Brick	30 ~ 50%
Foil insulation	60 ~ 70%
Concrete wall	80 ~ 90%
Aluminum siding	100%
Metal wall	100%

Remarks: RF signal reduction for reference

3.4 SETUP THE CONSOLE

Follow the procedure to setup the console connection with sensor(s) and WI-FI.

3.4.1 POWER UP THE DISPLAY CONSOLE

- Install the back-up CR2032 battery

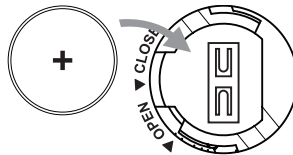

- Connect the display console power jack to AC power with the adaptor included.

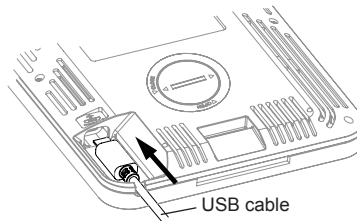

NOTE:

- The backup battery can backup: Time & Date & Max/Min weather records, rainfall records, Alert setting values, offset value of weather data and sensor(s) channel history.
- The built-in memory can backup: WI-FI setting, Hemisphere setting, Calibration values, and Sensor ID of paired sensor(s).
- Please always remove the back-up battery if the device is not going to be used for a while. Please keep in mind that even when the device is not in use, certain settings, such as the clock, alert settings and records in its memory, will still drain the back-up battery.

3.4.2 SETUP DISPLAY CONSOLE

1. Once the console power up, all the segments of the LCD will be shown.
2. The console will automatically start AP mode and show the "AP" icon on the screen, you can follow the section 6 to setup the WI-FI connection.

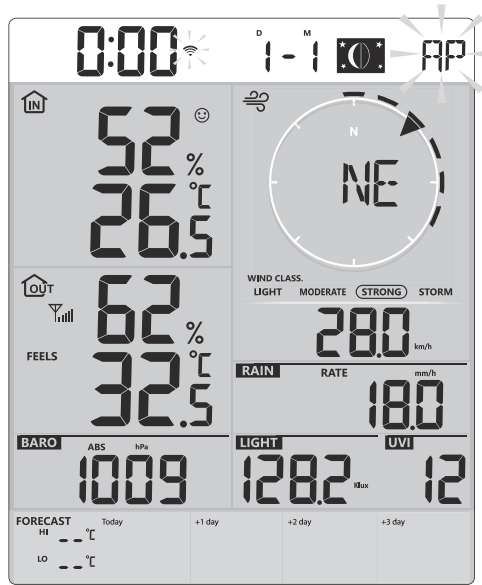

Start up screen (with 7-in-1 sensor connected)

NOTE:

If no display appears when power up the console, you can press [RESET] key by using a pointed object. If this process still not work, you can remove the backup battery and unplug the adapter then re-power up the console again.

3.4.3 SYNCHRONIZING WIRELESS 7-IN-1 SENSOR

Immediately after power up the console, while still in synchronization mode, the 7-in-1 sensor can be paired to the console automatically (as indicated by the flashing antenna Υ). User may also manually restart the synchronization mode by pressing the [SENSOR / WI-FI] key. Once they are paired up, the sensor signal strength indicator and weather reading will appear on your console display.

3.4.4 DATA CLEARING

During installation of the wireless 7-in-1 sensor, the sensors were likely to be triggered, resulting in erroneous rainfall and wind measurements. After the installation, user may clear out all the erroneous data from the display console. Simply press the [RESET] key once to re-start the console.

3.5 TABLE STAND INSTALLATION

The unit is designed for desktop or wall mount for easy viewing. Follow the steps to hook the table stand on the bottom of the console.

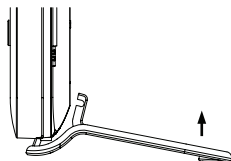

Step 1

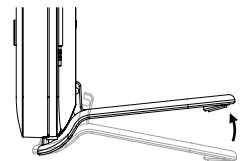

Step 2

4. DISPLAY CONSOLE FUNCTIONS AND OPERATION

4.1 SCREEN DISPLAY

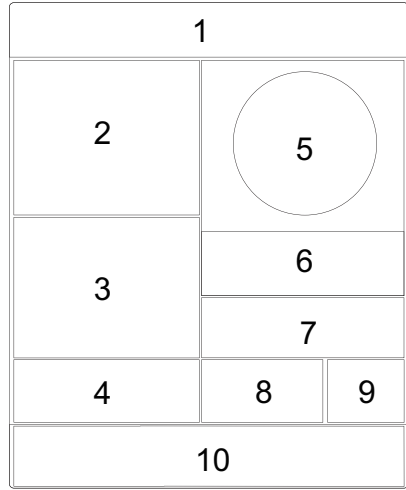
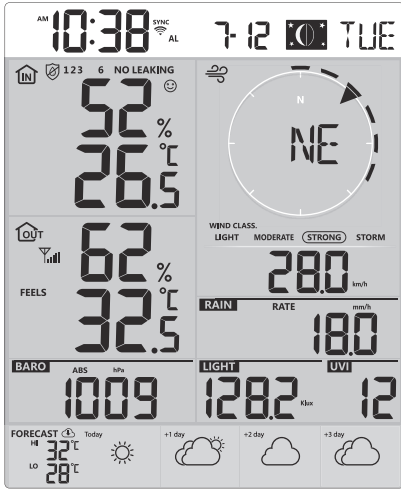

1. Time & Data, moon phase
2. Indoor / CH temperature & humidity
3. Outdoor temperature & humidity
4. Barometer
5. Wind direction
6. Wind speed
7. Rainfall & Rain rate
8. Light intensity
9. UV index
10. Today and 3 days Weather forecast

4.2 DISPLAY CONSOLE KEYS

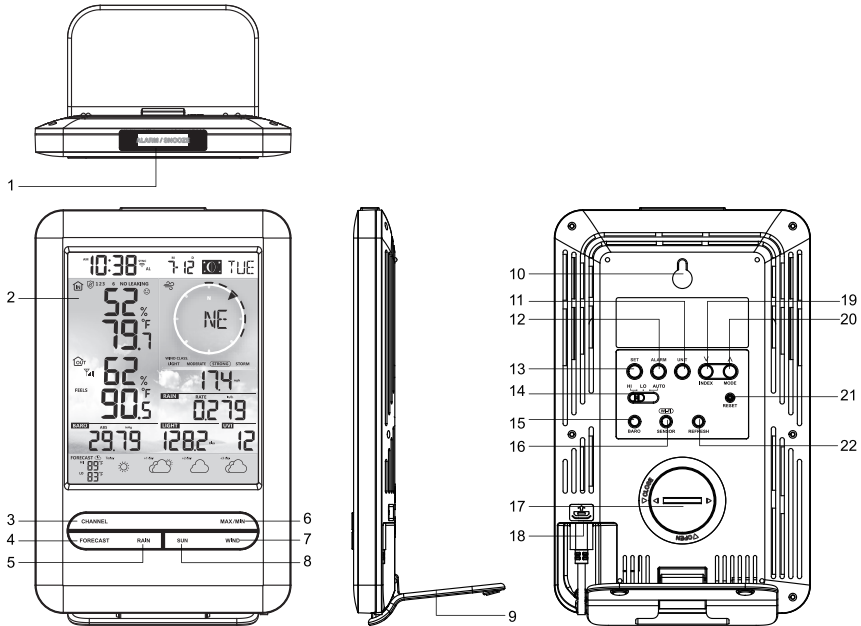















No.	Key / Part Name	Description
1	ALARM/SNOOZE/	During alarm, press to stop the alarm, press and hold for 2 seconds to stop current snooze.
2	Display screen	

3	CHANNEL	Press this button to switch between indoor and channels readings
4	FORECAST	Press to view the HI/LO temperature from today to next 3 days
5	RAIN	Press to switch between Rain Rate, rainfall
6	MAX / MIN	Press to switch between maximum and minimum values of Daily and Since last reset
7	WIND	Press to switch between average wind speed, wind gust and Beaufort Scale Press and hold 2 seconds to switch wind direction between language and 360 bearing
8	SUN	Press to switch between Solar Light Intensity and Sunburn time
9	Table stand	
10	Wall mount hole	
11	UNIT	Hold to enter unit of measurements setting
12	ALARM	Hold to enter alarm setting
13	SET	Hold to enter time and date setting
14	HI / LO / AUTO	Sliding to select the back light level mode
15	BARO	Switch between relative and absolute air pressure reading
16	SENSOR / WIFI	Press to start sensor synchronization (paring) Press and hold 6 seconds to enter AP mode, vice versa
17	Battery compartment	
18	Power jack	
19	∨ / INDEX	To switch between outdoor temperature, feels like, heat index, dew point and wind chill reading Decrease the value in setting
20	∧ / MODE	To switch between predicted HI & LO temperature, or predicted average temperature & chance of rain Increase the value in setting
21	RESET	Press to reset the console Press and hold 6 seconds to factory reset the console
22	REFRESH	Press to update the upload and download data

4.3 CONSOLE FEATURES

4.3.1 MULTI-DAY WEATHER FORECAST FOR TODAY & NEXT 3 DAY

Up to 15 different weather icons are provided according to the weather conditions forecasted:

				
Sunny	Partly cloudy	Cloudy / Foggy	Overcast	Windy
				
Light rain	Heavy rain	Partly cloudy with light rain	Partly cloudy with heavy rain	Thundery
				
Thundery showers	Stormy rain	Snowy	Snowy rain	Heavy Snowy rain

Based on the longitude and latitude of the device in your ProWeatherLive account, (refer to PWL setup), the console indicates the weather forecasts of today and next 3 days.



Multi day weather forecast section

Weather forecast with High (HI) and Low (LO) temperatures is default mode in this section, if update is normal, the icon will appear and update interval is per hour.

4.3.2 HIGH / LOW TEMPERATURE FORECAST FOR TODAY & NEXT 3 DAYS

By default, the console shows the High (HI) and Low (LO) temperatures of current day. To view the HI and LO temperatures from today to the next 3 days, simply press the [**FORECAST**] key as shown below.

Press 1 time to view today readings	FORECAST Today HI 32°C LO 28°C 	+1 day	+2 day	+3 day
Press again to view next day readings	FORECAST Today HI 30°C LO 27°C	+1 day	+2 day	+3 day
Press again to view second day readings	FORECAST Today HI 31°C LO 26°C	+1 day	+2 day	+3 day

4.3.3 AVERAGE TEMPERATURE FORECAST WITH CHANCE OF RAIN FOR TODAY & NEXT 3 DAYS

Instead of HI and LO temperatures, users can change to display Average temperature (AVG) and Chance of Rain of current day, by simply pressing the [**^ / MODE**] key.

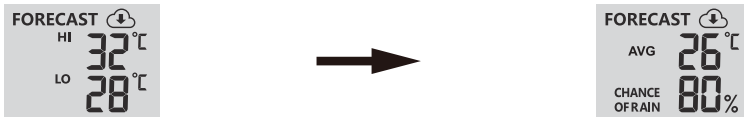

High / Low temperature mode

Avg temperature / chance of rain mode

To view the Average temperatures and Chance of Rain from today to the next 3 days, simply press the [**FORECAST**] key

Press 1 time to view today readings	FORECAST Today AVG 30°C CHANCE OF RAIN 0% 	+1 day	+2 day	+3 day
Press again to view next day readings	FORECAST Today AVG 29°C CHANCE OF RAIN 0%	+1 day	+2 day	+3 day
Press again to view second day readings	FORECAST Today AVG 29°C CHANCE OF RAIN 40%	+1 day	+2 day	+3 day

NOTE:

- This is on-line weather forecast service, please keep the console connected to ProWeatherLive, you can refer to section 5 and 6 for the WI-FI and PWL setup.
- Please input correct location for your device in ProWeatherLive "Edit device" page.
- If the Wi-Fi connectivity is not stable for over 3 hours, the weather forecast will not be shown and the icon will disappear.

4.3.4 OUTDOOR TEMPERATURE, HUMIDITY & TEMPERATURE INDEX

1. Outdoor sensor signal indicator to show the signal receiving strength
2. Outdoor sensor low battery indicator
3. Temperature index mode indicator
4. Outdoor Humidity reading
5. Outdoor Temperature reading

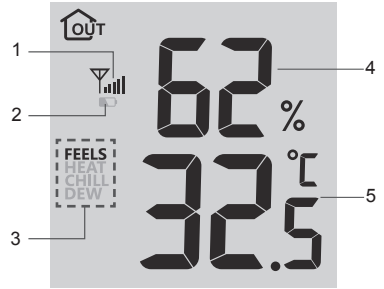

NOTE:

- If temperature / humidity is below the measurement range, the reading will show "Lo". If temperature / humidity is above the measurement range, the reading will show "Hi".
- Press [\checkmark / INDEX] key to switch between Outdoor temperature, Feels Like, Heat Index, Wind Chill, and Dew Point.

4.3.4.1 FEELS LIKE

Feels Like Temperature shows what the outdoor temperature will feel like. It's a collective mixture of Wind Chill factor (18°C or below) and the Heat Index (26°C or above). For temperatures in the region between 18.1°C to 25.9°C where both wind and humidity are less significant in affecting the temperature, the device will show the actual outdoor measured temperature as Feels Like Temperature.

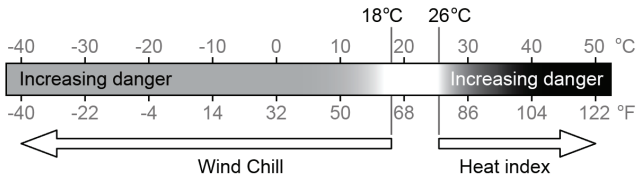

4.3.4.2 HEAT INDEX

The heat index which is determined by the wireless 7-IN-1 sensor's temperature & humidity data when the temperature is between 26°C (79°F) and 50°C (120°F).

Heat Index range	Warning	Explanation
27°C to 32°C (80°F to 90°F)	Caution	Possibility of heat exhaustion
33°C to 40°C (91°F to 105°F)	Extreme Caution	Possibility of heat dehydration
41°C to 54°C (106°F to 129°F)	Danger	Heat exhaustion likely
≥55°C (≥130°F)	Extreme Danger	Strong risk of dehydration / sun stroke

4.3.4.3 WIND CHILL

A combination of the wireless 7-IN-1 sensor's temperature and wind speed data determines the current wind chill factor. Wind chill number are always lower than the air temperature for wind values where the formula applied is valid (i.e. due to limitation of formula, actual air temperature higher than 10°C with wind speed below 9km/h may result in erroneous wind chill reading).

4.3.4.4 DEW POINT

- The dew point is the temperature below which the water vapor in air at constant barometric pressure condenses into liquid water at the same rate at which it evaporates. The condensed water is called *dew* when it forms on a solid surface.
- The dew point temperature is determined by the temperature & humidity data from wireless 7-IN-1 sensor.

4.3.5 INDOOR / CHANNELS TEMPERATURE & HUMIDITY

This section can show reading and status of the indoor, optional hygro-thermo sensor(s) and water leak sensor(s).

4.3.5.1 OVERVIEW

1. Auto loop icon
2. Indoor icon
3. Channel number and sensor signal strength icon
4. Channel sensor low battery indicator
5. Floating pool sensor icon
6. Soil moisture sensor icon
7. Water leak sensor status section
8. Comfort indication icons
9. Humidity reading section
10. Temperature reading section

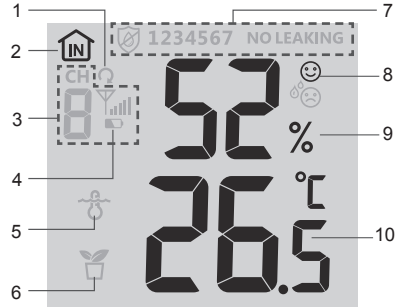

4.3.5.2 INDOOR TEMPERATURE & HUMIDITY

The indoor reading is default mode of the console.

This mode shown below information:

- Comfort indication
- Temperature and humidity reading of indoor



4.3.6 MULTI-CHANNEL AND SCROLL MODE FOR OPTIONAL SENSORS

You can add up to 7 additional Thermo-Hygrometer sensor (optional, refer to **section 3.2**). Press the [CHANNEL] key to switch between indoor and Channels 1 to 7.

For auto-scroll function, just press and hold the [CHANNEL] key for 3 seconds and the  icon will appear next to CH. The console will scroll the readings of all the sensors every 3 seconds.

This mode shown below information:

- Channel number of the current sensor
- Comfort indication of this sensor
- Temperature and humidity reading of this sensor
- Signal strength of this sensor.
- Sensor type icon (for water pool or soil moisture sensor)



4.3.7 WATER LEAK (OPTIONAL LEAK SENSOR)

You can add up to 7 additional Water Leak sensors (optional, refer to **section 3.2**)

The channel number(s) of the corresponding water leak sensor(s) added to the console will be shown with the NO LEAKING icon.



When water leaking is detected, the channel number of the sensor detecting the leaking will flash together the LEAKING icon.



NOTE:

When low battery is detected, the channel number of the sensor detecting the low battery condition will flash once every 4 seconds.

4.3.8 WIND

4.3.8.1 WIND SPEED AND DIRECTION SECTION OVERVIEW

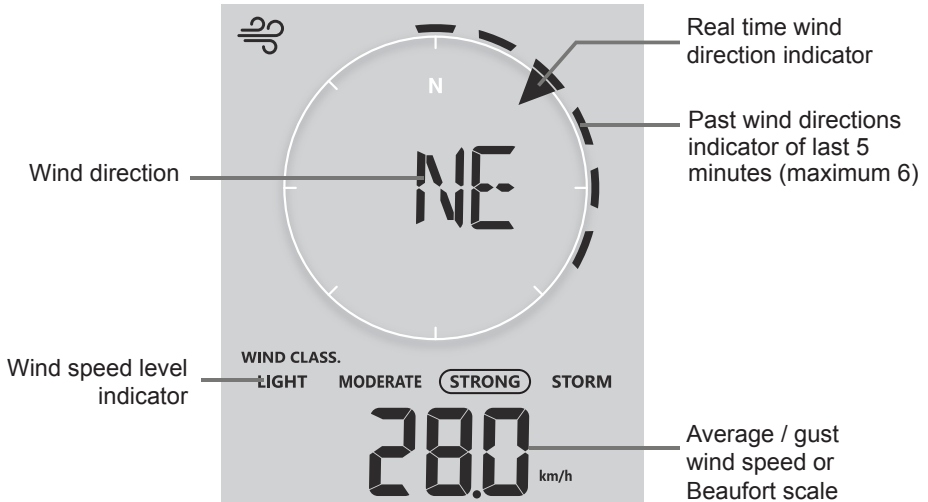

A solid arrow indicates the current real-time wind direction, whereas the bars indicate up to six different wind direction of the past 5 minutes.

4.3.8.2 WIND SPEED, GUST AND BEAUFORT SCALE DISPLAY

Press **[WIND]** key to switch display between Average wind speed, Gust, and Beaufort scale. The wind level provides a quick reference on the wind condition and is indicated by a series of text icons

Level	LIGHT	MODERATE	STRONG	STORM
Speed	2-8 mph 3-13 km/h	9-25 mph 14-41 km/h	26-54 mph 42-87 km/h	≥ 55 mph ≥ 88 km/h

NOTE:

- Windspeed is defined as the average wind speed in the 12 second update period
- Gust is defined as the peak wind speed in the 12 second update period

4.3.8.3 WIND DIRECTION IN 16-POINT DIRECTIONS AND DEGREES

By default, wind direction is displayed by a 16-point compass, which include N, E, S, W, NE, NW, SE, SW, NNE, ENE, SSE, ESE, NNW, WNW, SSW, WSW.

User can change to wind direction shown in 360 degrees.

Press and hold [**WIND**] key for 2 seconds until the wind direction is flashing. Press [**√ / INDEX**] or [**∧ / MODE**] key to select the display format between 16-point direction and 360 degrees.

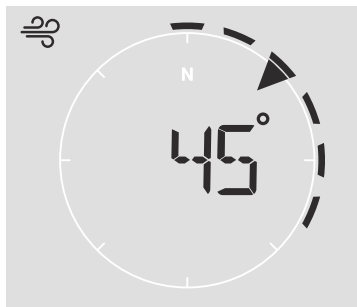

4.3.8.4 BEAUFORT SCALE TABLE

The Beaufort scale is an international scale of wind velocities ranging from 0 (calm) to 12 (Hurricane force).

Beaufort Scale	Description	Wind Speed	Land Condition
0	Calm	< 1 km/h	Calm. Smoke rises vertically.
		< 1 mph	
		< 1 knots	
		< 0.3 m/s	
1	Light air	1.1 ~ 5km/h	Smoke drift indicates wind direction. Leaves and wind vanes are stationary.
		1 ~ 3 mph	
		1 ~ 3 knots	
		0.3 ~ 1.5 m/s	
2	Light breeze	6 ~ 11 km/h	Wind felt on exposed skin. Leaves rustle. Wind vanes begin to move.
		4 ~ 7 mph	
		4 ~ 6 knots	
		1.6 ~ 3.3 m/s	
3	Gentle breeze	12 ~ 19 km/h	Leaves and small twigs constantly moving, light flags extended.
		8 ~ 12 mph	
		7 ~ 10 knots	
		3.4 ~ 5.4 m/s	
4	Moderate breeze	20 ~ 28 km/h	Dust and loose paper raised. Small branches begin to move.
		13 ~ 17 mph	
		11 ~ 16 knots	
		5.5 ~ 7.9 m/s	
5	Fresh breeze	29 ~ 38 km/h	Branches of a moderate size move. Small trees in leaf begin to sway.
		18 ~ 24 mph	
		17 ~ 21 knots	
		8.0 ~ 10.7 m/s	
6	Strong breeze	39 ~ 49 km/h	Large branches in motion. Whistling heard in overhead wires. Umbrella use becomes difficult. Empty plastic bins tip over.
		25 ~ 30 mph	
		22 ~ 27 knots	
		10.8 ~ 13.8 m/s	
7	High wind	50 ~ 61 km/h	Whole trees in motion. Effort needed to walk against the wind.
		31 ~ 38 mph	
		28 ~ 33 knots	
		13.9 ~ 17.1 m/s	

8	Gale	62 ~ 74 km/h	Some twigs broken from trees. Cars veer on road. Progress on foot is seriously impeded
		39 ~ 46 mph	
		34 ~ 40 knots	
		17.2 ~ 20.7 m/s	
9	Strong gale	75 ~ 88 km/h	Some branches break off trees, and some small trees blow over. Construction / temporary signs and barricades blow over.
		47 ~ 54 mph	
		41 ~ 47 knots	
		20.8 ~ 24.4 m/s	
10	Storm	89 ~ 102 km/h	Trees are broken off or uprooted, structural damage likely.
		55 ~ 63 mph	
		48 ~ 55 knots	
		24.5 ~ 28.4 m/s	
11	Violent storm	103 ~ 117 km/h	Widespread vegetation and structural damage likely.
		64 ~ 73 mph	
		56 ~ 63 knots	
		28.5 ~ 32.6 m/s	
12	Hurricane force	≥ 118 km/h	Severe widespread damage to vegetation and structures. Debris and unsecured objects are hurled about.
		≥ 74 mph	
		≥ 64 knots	
		≥ 32.7m/s	

4.3.9 BAROMETRIC PRESSURE

The atmospheric pressure is the pressure at any location of the earth caused by the weight of the column of air above it. One atmospheric pressure refers to the average pressure and gradually decreases as altitude increases. Meteorologists use barometers to measure atmospheric pressure. Because absolute atmospheric pressure decreases with altitude, meteorologist correct the pressure relative to sea-level conditions. Hence, your ABS pressure may read 1000 hPa at altitude of 300m, but the REL pressure is 1013 hPa.

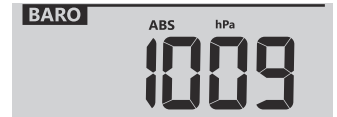

To obtain accurate REL pressure for your area, consult your local official observatory or check weather website on internet for real time barometer conditions, and then adjust the relative pressure in SETUP (section 6.4.1)

4.3.9.1 ABSOLUTE OR RELATIVE BAROMETRIC PRESSURE MODE

In normal mode, press [**BARO**] key to switch between ABSOLUTE and RELATIVE barometric pressure.

4.3.10 RAIN

The **RAINFALL** section shows the rainfall or rain rate information.

4.3.10.1 THE RAINFALL DISPLAY MODE

Press [**RAIN**] key to toggle between:

- RATE** - Current rainfall rate (base on 10 min rain data)
- HOURLY** - the total rainfall in the past hour
- DAILY** - the total rainfall from midnight (default)
- WEEKLY** - the total rainfall of the current week
- MONTHLY**- the total rainfall of the current calendar month
- TOTAL** - the total rainfall since the last reset

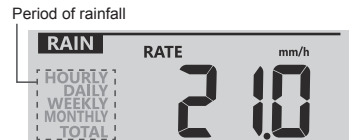

4.3.10.2 TO RESET THE TOTAL RAINFALL RECORD

In normal mode, press and hold [**RAIN**] key for 2 seconds to reset all the rainfall record.

NOTE:

Erroneous readings may occur during the installation of the 7-in-1 sensor array. Once the installation is completed and functioning correctly, it's advisable to clear all the data and start afresh.

4.3.11 LIGHT INTENSITY, UV INDEX & SUNBURN TIME

This section of display show the sunlight intensity, UV index and sunburn time.

4.3.11.1 LIGHT INTENSITY & SUNBURN TIME MODE:

During light intensity mode, press [SUN] key to switch between sunlight intensity and sunburn time

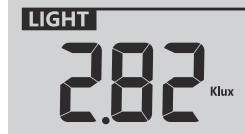

Light intensity mode

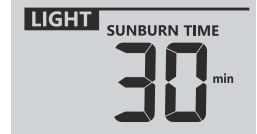

Sunburn time mode

UV INDEX VS SUNBURN TIME TABLE

Exposure level	Low		Moderate			High		Very high			Extreme	
UV index	1	2	3	4	5	6	7	8	9	10	11	12~16
Sunburn time	N/A		45 minutes			30 minutes		15 minutes			10 minutes	
Recommended protection	N/A		Moderate or high UV level! Suggest to wear sunglasses, broad brim hat and long-sleeved clothing.				Very high or Extreme UV level! Suggest to wear sunglasses, broad brim hat and long-sleeved clothing. If you have to stay outdoors, make sure to seek shade.					

NOTE:

- The sunburn time is based on normal skin type, it is just a reference of UV strength. In general, the darker one's skin is, the longer (or more radiation) it takes to affect the skin.
- The light intensity function is for sunlight detection.

4.3.11.2 UV INDEX MODE

To show the current UV index detected by the outdoor sensor.



4.3.12 MAXIMUM / MINIMUM RECORDS

The console can record MAX / MIN readings both daily and since last reset.

MAX 10	MIN 10	MAX 5	MIN 5
Daily MAX reading	Daily MIN reading	MAX reading since last reset	MIN reading since last reset

4.3.12.1 DAILY AND SINCE MAX / MIN RECORDS

In normal mode, press [MAX / MIN] key to check the records of the on screen reading in the following display sequence: daily MAX records → daily MIN records → since MAX records → since MIN records.

4.3.12.2 TO CLEAR THE MAX/MIN RECORDS

Press and hold [MAX / MIN] key for 2 seconds to reset all the MAX and MIN records.

4.3.13 MOON PHASE

The moon phase is determined by time and date of the console. The following table explains the moon phase icons of the Northern and Southern Hemispheres. Please refer to **section 6.3** web interface about how to setup for the Southern Hemisphere.

Northern Hemisphere	Moon Phase	Southern Hemisphere
	New Moon	
	Waxing Crescent	
	First quarter	
	Waxing Gibbous	
	Full Moon	
	Waning Gibbous	
	Third quarter	
	Waning Crescent	

4.3.14 WIRELESS SENSOR SIGNAL RECEIVING

1. The console display signal strength for the wireless sensor(s), as per table below:

	No signal	Weak signal	Good signal
Outdoor 7-in-1 sensor			
Hydro-thermal sensor channel	CH 	CH 	CH
Other optional sensor			

- If the signal has discontinued and does not recover within 15 minutes, the signal icon will disappear. The temperature and humidity will display “Er” for the corresponding channel.
- If the signal does not recover within 48 hours, the “Er” display will become permanent. You need to replace the batteries and then press [**SENSOR / WI-FI**] key to pair up the sensor again.

4.3.15 TIME SYNCHRONIZE STATUS

After the console has connected to the PWL, it can get the time from PWL that according to your selected time zone in PWL. The “**SYNC**” icon will appear on the LCD.



The time will automatically synchronize per hour. You can also press the [**REFRESH**] key to get the Internet time manually within 1 minute.

4.3.16 WI-FI CONNECTION STATUS

WI-FI icon on the console display indicates the console's connection status with WI-FI router.

Stable: Console is in connection with WI-FI router	Flashing: Console is trying to connect to WI-FI router

4.4 OTHER SETTING

4.4.1 TIME, DATE AND GENERAL SETTING

Press and hold the [**SET**] button for 2 seconds to enter the setting mode. Press [**∨ / INDEX**] or [**∧ / MODE**] button to adjust, and press [**SET**] to proceed with next step of the setting. Please refer to following setting procedures.

Step	Mode	Setting procedure
1	Hour	Press [∨ / INDEX] or [∧ / MODE] key to adjust the hour
2	Minute	Press [∨ / INDEX] or [∧ / MODE] key to adjust the minute
3	12/24 hour format	Press [∨ / INDEX] or [∧ / MODE] key to select 12 or 24 hour format
4	Year	Press [∨ / INDEX] or [∧ / MODE] key to adjust the year
5	Month	Press [∨ / INDEX] or [∧ / MODE] key to adjust the month
6	Day	Press [∨ / INDEX] or [∧ / MODE] key to adjust the day
7	M-D/D-M format	Press [∨ / INDEX] or [∧ / MODE] key to select "Month / Day" or "Day / Month" display format
8	Time sync ON/OFF	Press [∨ / INDEX] or [∧ / MODE] key to enable or disable Time Sync function. If you want to set the time manually, you should set Time Sync OFF
9	Weekday language	Press [∨ / INDEX] or [∧ / MODE] key to select weekday display language

NOTE:

- In normal mode, press [**SET**] key to switch between year and date display.
- During the setting, you can back to normal model by press and hold [**SET**] key for 2 seconds.

4.4.2 SETTING ALARM TIME

1. In normal time mode, press and hold [**ALARM**] key for 2 seconds until the alarm hour digit flashes to enter alarm time setting mode.
2. Press [**∨ / INDEX**] or [**∧ / MODE**] key to change the value. Press and hold the key for quick-adjust.
3. Press [**ALARM**] key again to step the setting value to Minute with the Minute digit flashing.
4. Press [**∨ / INDEX**] or [**∧ / MODE**] key to adjust the value of the flashing digit.
5. Press [**ALARM**] key to save and exit the setting.

NOTE:

- In alarm mode, the "  " icon will display on the LCD.
- The alarm function will turn on automatically once you set the alarm time.

4.4.2.1 ACTIVATING ALARM AND TEMPERATURE PRE-ALARM FUNCTION

1. In normal mode, press [**ALARM**] key to show the alarm time for 5 seconds.
2. When the alarm time displays, press [**ALARM**] key again to activate the alarm function. **Or** press [**ALARM**] key twice to activate the alarm with ice pre-alarm function.

		
Alarm off	Alarm on	Alarm with ice-alert

NOTE:

Once the ice pre-alert activates, the pre-set alarm will sound and ice-alert icon will flash 30 minutes earlier if the outdoor temperature is below -3°C.

When clock reach the alarm time, alarm sound will start.

Where it can be stopped by following operation:

- Auto-stop after 2 minutes alarming if without any operation and the alarm will activate again in the next day.
- By pressing [**ALARM / SNOOZE**] key to enter snooze that the alarm will sound again after 5 minutes.

- By pressing and hold [ALARM / SNOOZE] key for 2 seconds to stop the alarm and will activate again in the next day
- By pressing [ALARM] key to stop the alarm and the alarm will activate again in the next day.

NOTE:

- The snooze could be used continuously in 24 hours.
- During the snooze, the alarm icon "🔔" will keep flashing.

4.4.3 UNIT SETTING

Use the [UNIT] key to change the unit of measure of the reading on the console display.

Below is the operation step:

- Press and hold [UNIT] key for 2 seconds to enter the unit setting mode.
- Short press [UNIT] key to proceed to the next setting step.
- Press [∨ / INDEX] or [∧ / MODE] key to change the value. Press and hold the key for quick-adjust.
- Press and hold [UNIT] key for 2 seconds to exit the unit setting mode at any time.

Setting items table:

Step	Mode	Setting procedure
1	Temperature unit	Press [∨ / INDEX] or [∧ / MODE] key to select °C or °F
2	Rain unit	Press [∨ / INDEX] or [∧ / MODE] key to select mm or in
3	Wind speed unit	Press [∨ / INDEX] or [∧ / MODE] key to select m/s, km/h, knots or mph
4	Baro pressure unit	Press [∨ / INDEX] or [∧ / MODE] key to select hPa, inHg or mmHg
5	Light intensity	Press [∨ / INDEX] or [∧ / MODE] key to select Klux, Kfc or W/m ²

4.4.4 BACK LIGHT

The main unit back light can be adjust, using the [HI / LO / AUTO] sliding switch to select the appropriate brightness:

- Slide to the [HI] position for the brighter back light.
- Slide to the [LO] position for the dimmer back light.
- Slide to the [AUTO] position for the auto adjust back light that according to environment light level.

5. CREATE PWL ACCOUNT & SETUP WI-FI CONNECTION OF CONSOLE

The console can upload /download weather data in ProWeatherLive (PWL) cloud server through WI-FI router, you can follow the step below to setup your device.

NOTE:

ProWeatherLive (PWL) website and APP are subjected to change without notice.

5.1 CREATE PWL ACCOUNT AND ADD NEW DEVICE IN PWL

1. In <https://proweatherlive.net> click the "Create Your Account" then follow the instructions to create your account.

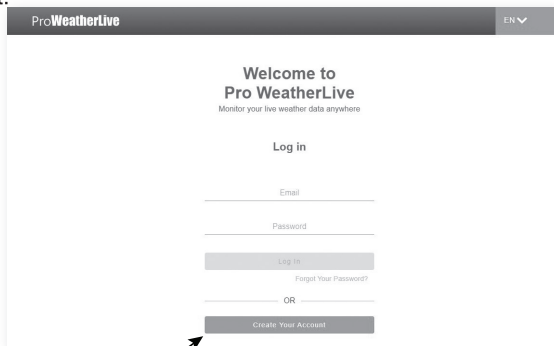

2. Log in the ProWeatherLive and then click the **"Edit Devices"** in the pull down menu.

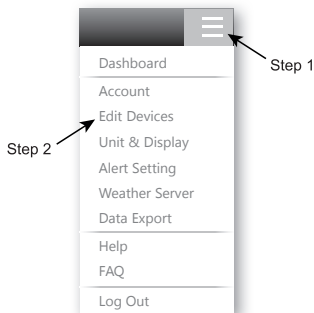

3. In "Edit Devices" page, click the **"Add"** on the top right corner to create a new device, it will generate the station ID and Key instantly, jot down both and then click **"FINISH"** to create the station tab.

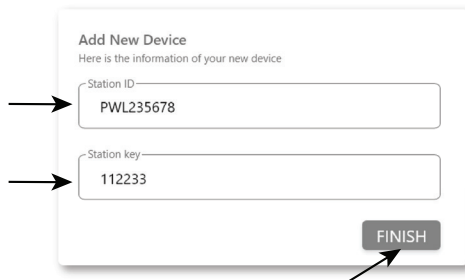

4. Click the **"Edit"** on the top right corner of the station tab.

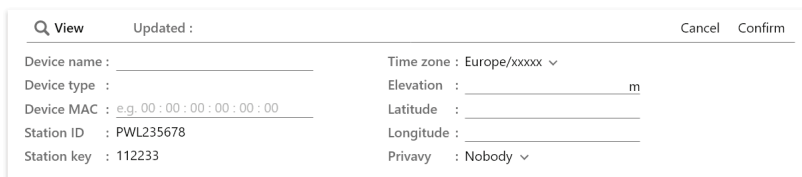

5. Key-in the "Device name", "Device MAC address", "Elevation", "Latitude", "Longitude" and select your time zone in the station tab, them click "confirm" to save the setting.



NOTE:

Enter a negative sign for Latitudes or Longitudes when it's South or West respectively.

For example,

33.8682 South is "-33.8682"; 74.3413 West is "-74.3413"

The device Mac address can be found on the backside of the console or in the "SETUP" page mentioned in **section 6.3**.

The weather forecast and weather condition will be based on the Latitudes and Longitudes entered, which are also used for calculations of sunrise, sunset, moon rise and moon set times.



Mac address of the device

6. In the "SETUP" page mentioned in **section 6.3**, enter the Station ID and key assigned by ProWeatherLive.

Weather server setup

ProWeatherLive

Station ID: PWL2345678

Station key: 112233

6. CONNECT CONSOLE TO WI-FI

6.1 CONSOLE IN ACCESS POINT MODE

- When you power up the console for the first time, the console LCD will show flashing "AP" and "📶" icon to signify that it has entered AP (Access Point) mode, and is ready for WI-FI settings. User can also press and hold the [**SENSOR / WI-FI**] key for 6 seconds to enter AP mode manually.

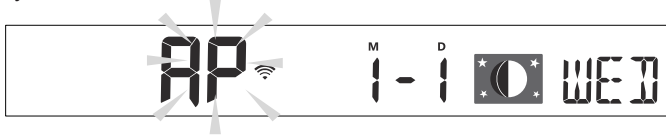

6.2 CONNECT TO THE CONSOLE

- Use PC/Mac, smart phone or tablet to connect with the console through WI-FI network setting.
- In PC/Mac WI-FI network settings, or In Android / iOS smart phones setting → connect WI-FI to the console's PWS WI-FI network as shown in figures below (console WI-FI network name will always begin with PWS-) :

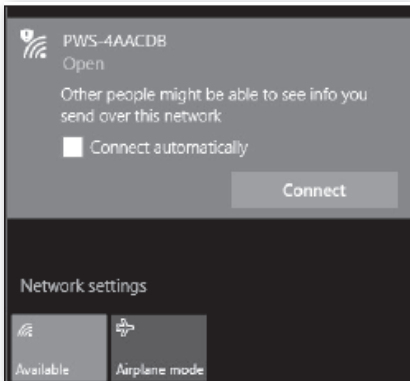

E.g. PC WI-FI network interface

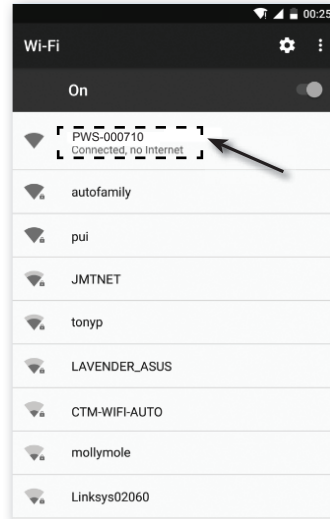

E.g. Android smart phone WI-FI network interface

- Once connected, enter the following IP address into your Internet browser's address bar, to access the console's SETUP web interface:

<http://192.168.1.1>

NOTE :

- Some browsers will treat **192.168.1.1** as a search, so make sure you include header **http://**.
- If you cannot enter the console's web interface, please turn off the mobile data / network in your smart phone and try again.
- Recommended browsers include the latest version of Chrome, Safari, Edge, Firefox or Opera.
- WI-FI network interface of PC/Mac or smart phone may be subject to change.

6.3 SETUP THE WEATHER SERVER CONNECTION

Enter the information into the following web interface "SETUP" page. Ensure all information is entered prior to pressing  to connect the console to ProWeatherLive.

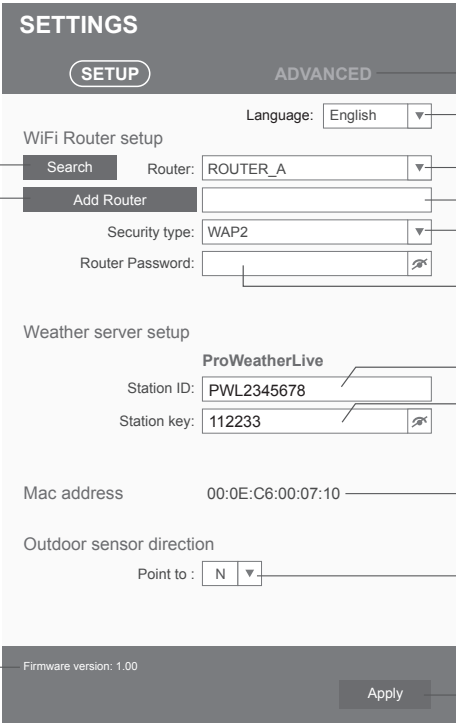

The screenshot shows the "SETTINGS" page with the "ADVANCED" tab selected. The "WiFi Router setup" section includes a "Search" button, a "Router" dropdown menu (set to "ROUTER_A"), an "Add Router" button, a "Security type" dropdown menu (set to "WAP2"), and a "Router Password" field with a visibility icon. The "Weather server setup" section includes a "Station ID" field (set to "PWL2345678"), a "Station key" field (set to "112233"), and a "Mac address" field (set to "00:0E:C6:00:07:10"). The "Outdoor sensor direction" section includes a "Point to:" dropdown menu (set to "N"). At the bottom, the "Current firmware version" is displayed as "Firmware version: 1.00" and an "Apply" button is present.

Annotations:

- Press "ADVANCED" icon to advanced page
- Select setup UI display language
- Press to search router
- Press to allow add router manually
- Select router (SSID) for connection
- Manually enter the SSID if not on list
- Select router's security type
- Router password (leave blank if the security type is "Open")
- Enter station ID and key assigned by the ProWeatherLive (PWL)
- Device Mac address
- Select the sensor located hemisphere (e.g. US and EU countries are "N" Australia is "S")
- Current firmware version
- Press to complete the WI-FI related setting

SETUP page

NOTE:

- If you don't have station ID and station key available for the upload, you need to first create an account at ProWeatherLive (PWL), followed by registering the product to obtain the ID and key. For details, please refer to "Create PWL account and add new device in PWL" in **section 5**.
- When WI-FI setup is completed, your PC/Mac or smart phone will resume its default WI-FI connection.
- During AP mode, you can press and hold the [**SENSOR / WI-FI**] key for 6 seconds to stop AP mode and the console will restore your previous setting.
- Changing the hemisphere setting will automatically switch the direction of the moon phase on the display.

6.4 ADVANCE SETTING IN WEB INTERFACE

Press **"ADVANCED"** key at the top of web interface to enter the advance setting page, this page allow you to set and view the calibration data of the console, as well as update the firmware version on PC/Mac web browser.

The screenshot shows the 'ADVANCED' settings page. At the top, there are 'SETUP' and 'ADVANCED' buttons. Below this, there are sections for Temperature, Humidity, Pressure, and various gain/offset settings. At the bottom, there is a 'Firmware version' section with 'Browse' and 'Upload' buttons.

Annotations:

- Press "SETUP" icon to setup page
- Select setting unit
- In/Outdoor & CH 1~7 temperature calibration section
- In/Outdoor & CH 1~7 humidity calibration section
- Select setting unit
- Pressure calibration section
- Current offset value is the value that you set before to offset the pressure reading
- The rain, wind speed, UV and light calibration use gain method. The wind direction is +/- 90 offset
- The PM2.5 and PM10 is +/-99 offset (PM2.5 /10 calibration setting is for optional sensor only)
- Current firmware version
- The firmware update function only available in PC/Mac web browser

ADVANCED page

6.4.1 CALIBRATION

1. User can input the offset and/or gain values for different parameters while current offset and gain values are shown next to their corresponding blank.
2. Once completed, press **Apply** at the bottom of the SETUP page.

The current offset value will show the previous value that you entered, please input the new value in the blank if any changes needed, the new value will effective once you press **Apply** icon in SETUP page.



NOTE:

Calibration of most parameter is not required, with the exception of Relative Pressure, which must be calibrated to sea-level to account for altitude effects.

7. PROWEATHERLIVE (PWL) LIVE DATA & OPERATION

7.1 VIEW LIVE DATA

Login your ProWeatherLive account.

Once your device is connected, your device's live weather data will show on the dashboard page.

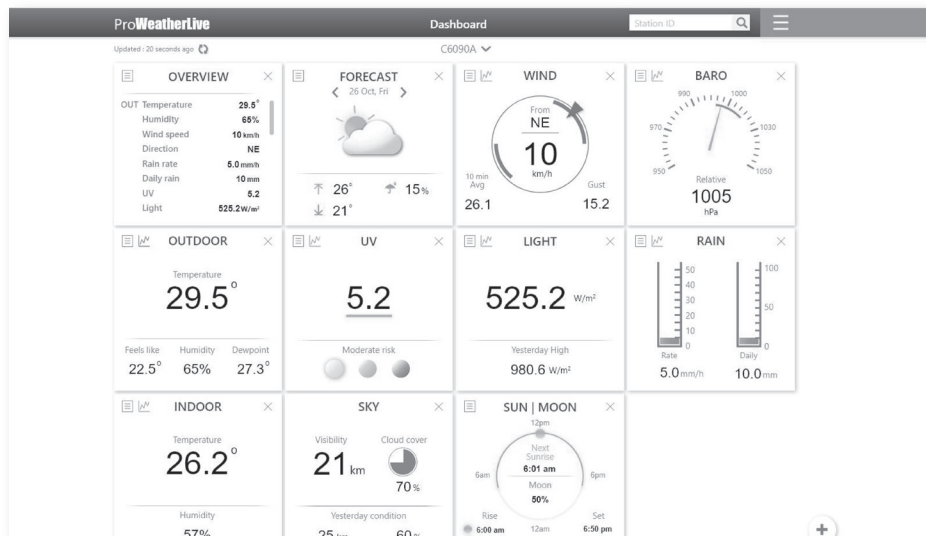

NOTE:

Please press "Help" in the **☰** should you have any query on the PWL operation.

7.2 UPLOAD TO OTHER WEATHER SERVERS

The ProWeatherLive.net service allows data from each weather station to be upload to other 2 weather servers, such as WeatherUnderground, WeatherCloud, PWSWeather, or AWEKAS. For more information about their setup (e.g. creation of account, station ID and key), please refer to the HELP menu on ProWeatherLive.net.

8. MAINTENANCE

8.1 FIRMWARE UPDATE

The console supports OTA firmware update capability. Its firmware may be updated over the air anytime (whenever necessary) through any web-browser on a PC/Mac with WI-FI connectivity. Update function, however, is not available through mobile/smart devices.



8.1.1 FIRMWARE UPDATE STEP

1. Download the latest version firmware to your PC/Mac.
2. Set the console into AP (access point) mode then connect the PC/Mac to the console (refer to **section 6.1** and **6.2**).
3. From the SETUP page, press ADVANCED to enter advance setting
4. Under the firmware upload section, press **Browse** to locate the firmware file saved on your PC/Mac.
5. Press **Upload** to start firmware update.

The update time is around 5 ~ 10 minutes. While updating, the progress will be displayed (i.e. 100 is completion).



6. The console will restart once the update is completed.
7. The console will stay in **AP mode** for you to check the firmware version and all the current setting. Simply press and hold [**SENSOR / WI-FI**] key for 6 seconds to exit AP mode.

IMPORTANT NOTE:

- Please keep connecting the power during the firmware update process.
- Please make sure your PC/Mac's WI-FI connection is stable.
- When the update process start, do not operate the PC/Mac and console until the update finished.
- During firmware update the console will stop upload data to the cloud server. It will reconnect to your WI-FI router and upload the data again once the firmware update succeed. If the console cannot connect to your router, please enter the SETUP page to setup again.
- After the firmware update, If the setup informations are missing, please input the setup information again.
- Firmware update process have potential risk, which cannot guarantee 100% success. If the update fail, please redo the above step to update again.

8.2 BATTERY REPLACEMENT

When low battery indicator “” is displayed near the antenna icon of the sensor(s), it indicates that the outdoor 7-IN-1 sensor and/or current channel sensor(s) battery power is low respectively. Please replace with new batteries.

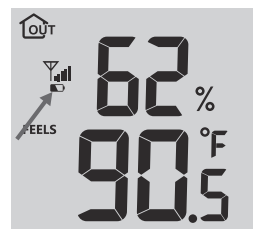

8.2.1 RE-PAIRING THE SENSOR(S) MANUALLY

Whenever you changed the batteries of the 7-in-1 weather sensor array or other additional sensors, re-synchronization must be done manually.

1. Change all the batteries to new ones in the low battery sensor(s).
2. Press [**SENSOR / WI-FI**] key on the console to enter sensor synchronization mode (as indicated by the flashing antenna Υ).

8.3 RESET AND FACTORY RESET

To reset the console and start again, press the [**RESET**] key once or remove the backup battery and then unplug the adapter.

To resume factory settings and remove all data, press and hold the [**RESET**] key for 6 seconds.

8.4 WIRELESS 7-IN-1 SENSOR ARRAY MAINTENANCE

REPLACE THE WIND VANE

Unscrew and remove the wind vane for replacement

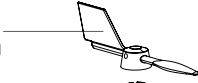

REPLACE THE WIND CUP

1. Unscrew and remove the top cap
2. Remove the wind cup for replacement



CLEANING HYGRO-THERMO SENSOR

1. Remove the 2 screws at the bottom of the radiation shield.
2. Gently pull out the shield.
3. Carefully remove any dirt or insects on the sensor (do not let the sensors inside get wet).
4. Clean the shield with water to remove any dirt or insects.
5. Install all the parts back when they are clean and fully dried.

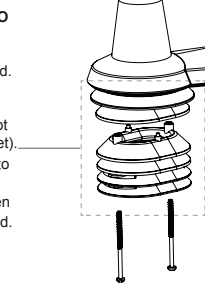

CLEANING THE RAIN COLLECTOR

1. Rotate the rain collector by turning it 30° anti-clockwise.
2. Gently remove the rain collector
3. Clean and remove any debris or insects.
4. Install the collector when it is clean and fully dried.

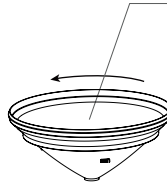

CLEANING THE UV SENSOR AND CALIBRATION

- For precision UV measurement, gently clean the UV sensor cover lens with damp micro-fiber cloth.
- Over time, the UV sensor will naturally degrade. The UV sensor can be calibrated with a utility grade UV meter, please refer to Calibration section in previous page for about the UV sensor calibration.

9. TROUBLESHOOT

Problems	Solution
7-in-1 wireless sensor is intermittent or no connection	<ol style="list-style-type: none"> 1. Make sure the sensor is within the transmission range 2. If it still does not work, reset the sensor and resynchronize with console
Additional wireless sensor(s) is/are intermittent or no connection	<ol style="list-style-type: none"> 1. Make sure the sensor(s) is/are within the transmission range 2. Make sure the channel displayed match to the channel selection on sensor 3. If it still does not work, reset the sensor and resynchronize with console
No WI-FI connection	<ol style="list-style-type: none"> 1. Check the WI-FI icon on the display, it should be on if connectivity is successful 2. In the console SETUP page, make sure the WI-FI settings (router's name, security type, password) are correct 3. Make sure you connect to 2.4G band of the WI-FI router (5G not supported)
Data not reporting to ProWeatherLive	<ol style="list-style-type: none"> 1. In the console SETUP page, ensure your Station ID and Station Key are correct 2. In the "Edit Devices" of the console on PWL, ensure the Device Mac address is entered correctly
Multi-day forecast, cloud cover, visibility, sunrise/sunset, moon rise/moon set times are not accurate	<ol style="list-style-type: none"> 1. Ensure your console is connected to PWL 2. Ensure latitude, longitude & time zone in "Edit Devices" of the console on PWL are correct 3. Press the [REFRESH] key to update the data instantly
Sunrise/sunset, moon rise/moon set times are different to that of PWL	<ol style="list-style-type: none"> 1. Ensure your console is connected to PWL 2. Ensure the console Time Sync is set to ON
Rainfall is not correct	<ol style="list-style-type: none"> 1. Make sure the rain collector is clean for the tipping bucket to tip smoothly 2. Make sure the sensor has stable and level mounting to ensure correct tipping
Temperature reading too high in the day time	<ol style="list-style-type: none"> 1. Place the sensor in open area and at least 1.5m off the ground. 2. Ensure that the sensor is placed away from heat generating sources or structures, such as buildings, pavement, walls or air conditioning units.
Some condensation beneath the UV sensor may occur overnight	This will disappear when temperature rises up under the sun and will not affect the performance of the unit.

10. SPECIFICATIONS

10.1 CONSOLE

General Specification

Dimensions (W x H x D)	118 x 192.5 x 21mm (4.6 x 7.6 x 0.8 in) without attach table stand
Weight	269g (with battery)
Main power	DC 5V, 1A adapter
Backup battery	CR2032
Operating temperature range	-5°C ~ 50°C

WI-FI Communication Specification

Standard	802.11 b/g/n
Operating frequency :	2.4GHz
Supported router security type	WPA/WPA2, WPA3, OPEN, WEP (WEP only support Hexadecimal password)
Supported device for setup UI	Built-in WI-FI with AP mode function smart devices or laptops e.g.: Android smart phone, Android pad, iPhone, iPad or PC/ Mac computer.
Recommended web browser for setup UI	Web browsers that support HTML 5, such as the latest version of Chrome, Safari, Edge, Firefox or Opera.

Online Platform

Website	https://proweatherlive.net
App name	ProWeatherLive
App platform	Google play and Apple Store

Wireless Sensor side Communication Specification

Support sensors	- 1 Wireless 7-IN-1 weather outdoor sensor - Up to 7 Wireless hygro-thermo sensors / soil moisture sensor / pool sensor (optional) - Up to 7 Wireless water leak sensors (optional)
RF frequency	917Mhz
RF transmission range	150m

Time Related Function Specification

Time display	HH: MM
Hour format	12hr AM / PM or 24 hr
Date display	DD / MM or MM / DD
Time synchronize method	Through PWL to get the local time of the console location
Weekday languages	EN / DE / FR / ES / IT / NL / RU

Barometer (Note: Data detected by console)

Barometer unit	hPa, inHg and mmHg
Measuring range	540 ~ 1100hPa
Accuracy	(700 ~ 1100hPa ± 5hPa) / (540 ~ 696hPa ± 8hPa) (20.67 ~ 32.48inHg ± 0.15inHg) / (15.95 ~ 20.55inHg ± 0.24inHg) (525 ~ 825mmHg ± 3.8mmHg) / (405 ~ 522mmHg ± 6mmHg) Typical at 25°C (77°F)
Resolution	1hPa / 0.01inHg / 0.1mmHg

Memory modes	Historical data of past 24 hours, daily Max / Min
Indoor Temperature (Note: Data detected by console)	
Temperature unit	°C and °F
Accuracy	5.1 ~ 60°C ± 0.4°C (41.2 ~ 140°F ± 0.7°F) -19.9 ~ 5°C ± 1°C (-3.8 ~ 41°F ± 1.8°F) -40 ~ -20°C ± 1.5°C (-40 ~ -4°F ± 2.7°F)
Resolution	°C / °F (1 decimal place)
Indoor Humidity (Note: Data detected by console)	
Humidity unit	%
Accuracy	1 ~ 20% RH ± 6.5% RH @ 25°C (77°F) 21 ~ 80% RH ± 3.5% RH @ 25°C (77°F) 81 ~ 99% RH ± 6.5% RH @ 25°C (77°F)
Resolution	1%
Memory modes	Historical data of past 24 hours, Max / Min
Outdoor Temperature (Note: Data detected by 7-in-1 sensor)	
Temperature unit	°C and °F
Weather index mode	Feels like, Wind Chill, Heat Index and Dew point
Feels like display range	-65 ~ 50°C
Dew point display range	-20 ~ 80°C
Heat index display range	26 ~ 50°C
Wind chill display range	-65 ~ 18°C (wind speed >4.8km/h)
Accuracy	5.1 ~ 60°C ± 0.4°C (41.2 ~ 140°F ± 0.7°F) -19.9 ~ 5°C ± 1°C (-3.8 ~ 41°F ± 1.8°F) -40 ~ -20°C ± 1.5°C (-40 ~ -4°F ± 2.7°F)
Resolution	°C / °F (1 decimal place)
Outdoor Humidity (Note: Data detected by 7-in-1 sensor)	
Humidity unit	%
Accuracy	1 ~ 20% RH ± 6.5% RH @ 25°C (77°F) 21 ~ 80% RH ± 3.5% RH @ 25°C (77°F) 81 ~ 99% RH ± 6.5% RH @ 25°C (77°F)
Resolution	1%
Wind Speed & Direction (Note: Data detected by 7-in-1 sensor)	
Wind speed unit	mph, m/s, km/h and knots
Wind speed display range	0 ~ 112mph, 50m/s, 180km/h, 97knots
Resolution	mph, m/s, km/h and knots (1 decimal place)
Speed accuracy	< 5m/s: +/- 0.5m/s; > 5m/s: +/- 10% (whichever is greater)
Display mode	Gust / Average
Wind direction display mode	16 directions or 360 degree
Rain (Note: Data detected by 7-in-1 sensor)	
Unit for rainfall	mm and in
Unit for rain rate	mm/h and in/h
Accuracy	± 7% or 1 tip
Range	0 ~ 19999mm (0 ~ 787.3 in)
Resolution	0.254mm (3 decimal place in mm)
Rain display mode	Rate / Hourly / Daily / Weekly / Monthly / Total rainfall
UV index (Note: Data detected by 7-in-1 sensor)	
Display range	0 ~ 16

Resolution	1 decimal place
LIGHT INTENSITY (Note: Data detected by 7-in-1 sensor)	
Light intensity unit	Klux, Kfc and W/m ²
Display range	0 ~ 200Klux
Resolution	Klux, Kfc and W/m ² (2 decimal place)

10.2 WIRELESS 7-IN-1 SENSOR

Dimensions (W x H x D)	390 x 217 x 165 mm (15.3 x 8.5 x 6.5in)
Weight	543g (with Batteries)
Main power	3 x AA size 1.5V batteries (Lithium batteries recommended)
Weather data	Temperature, Humidity, Wind speed, Wind direction, Rainfall, UV and light intensity
RF transmission range	150m
RF frequency	917Mhz
Transmission interval	- 12 seconds for UV, light intensity, wind speed and wind direction data - 24 seconds for temperature, humidity and rain data
Operating temperature range	-40 ~ 60°C (-40 ~ 140°F) Lithium batteries required for low temperature
Operating humidity range	1 ~99% RH non-condensing

10.3 SENSOR SPECIFICATIONS

Dimensions (W x H x D)	125 x 58 x 19 mm (4.9 x 2.2 x 0.7 in)
Weight	144g (with batteries)
Main power	2 x AA size 1.5V batteries (Lithium battery recommended for low temperature environment)
Weather data	Temperature and humidity
RF frequency	917MHz
RF transmission range	150m (492 feet) straight distance
Temperature Accuracy	5.1 ~ 60°C ± 0.4°C (41.2 ~ 140°F ± 0.7°F) -20 ~ 5°C ± 1°C (-4 ~ 41°F ± 1.8°F)
Humidity Accuracy	1 ~ 20% RH ± 6.5% RH @ 25°C (77°F) 21 ~ 80% RH ± 3.5% RH @ 25°C (77°F) 81 ~ 99% RH ± 6.5% RH @ 25°C (77°F)
Number of channels	7 (CH1 ~ 7)
Transmission interval	60 seconds
Operating temperature range	-20 ~ 60°C (-20 ~ 140°F)
Operating humidity range	RH 1% to 99 %

Distributed by:
Electus Distribution Pty Ltd
46 Eastern Creek Dr,
Eastern Creek NSW 2766 Australia
Ph 1300 738 555

www.electusdistribution.com.au