

User's Manual

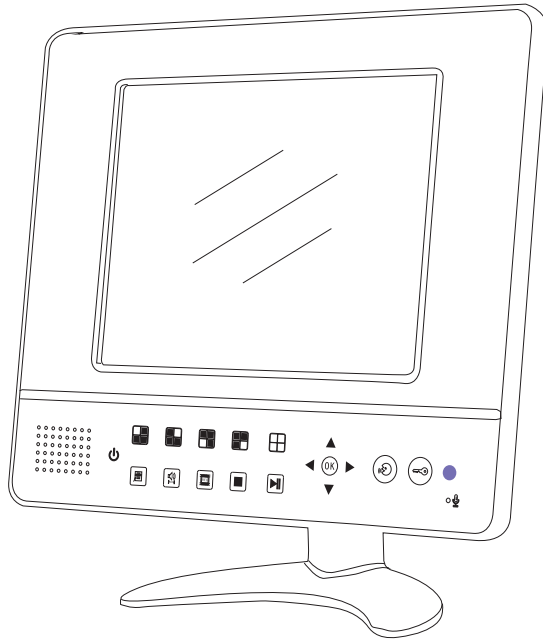

**8" LCD QUAD MONITOR / DVR COMBO
WITH VIDEO DOOR PHONE FUNCTION**

LIST

CHAPTER 1 BRIEF INTRODUCTION	
1.1 Features	1
CHAPTER 2 INSTALLATION GUIDE	
2.1 What is included?	2
2.2 Description	3
2.3 Preparation before installation	4
2.4 Insert the hard disk	4
2.5 Installation	5
CHAPTER3 OPERATION	
3.1 How to turn on/off	8
3.2 Operation buttons	10
CHAPTER 4 SETUP	
4.1 Camera on/off	11
4.2 Record on/off	12
4.3 Covert function	13
4.4 Audio port	13
4.5 Recording frame rate	14
4.6 Video quality	14
4.7 Recording schedule	15
4.8 Motion detection	16
4.9 Alarm setup	18
4.10 Hard disk drive	19
4.11 General	20
4.12 Default	23
CHAPTER 5 NETWORK	
5.1 Basic setting of network	24
5.2 Open HTTP port	28
5.3 Remote monitoring and control	29
5.4 DDNS setup	33
CHAPTER 6 VIDEO PLAYBACK	
6.1 Playback on monitor	35
6.2 Playback with PC	37

CHAPTER 1 BRIEF INTRODUCTION

1.1 Features

- Inputs & Outputs: 4-channel CCTV video input, 2-channel video door phone input, 2-channel audio input, 2-channel alarm input, 1-channel alarm output, 1-channel audio/video output.
- High resolution video display.
- Support PAL/NTSC system.
- Linux operating system.
- 24-hour scheduled recording: no recording, always recording, and sensor(alarm/motion detection) recording.
- Get recorded video from events list or by time.
- Covert camera function.
- Password protection function.
- Remote control / Touch button operation.
- Support max 500G hard disk drive.

CHAPTER 2 INSTALLATION GUIDE

2.1 What is included?

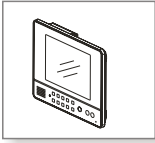

Monitor



Remote Controller

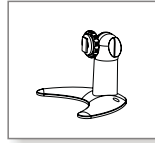

Desktop Bracket

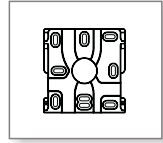

Wall-mounted
Bracket

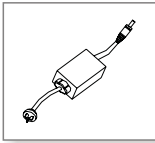

AC Power Adaptor



User's
Manual

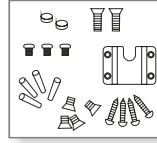

Screws

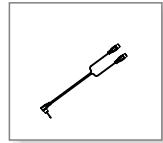

A/V
Output Line

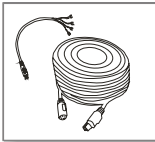

4P Connector

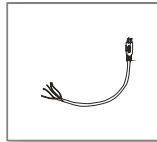

5P Connector

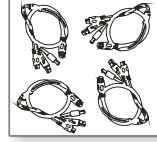

6P BNC
Connector

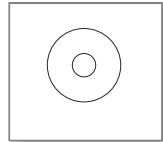

CD

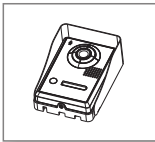

Door Station

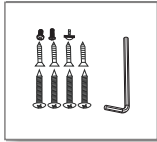

Screw and others

Fig.1

2.2 Description

• Monitor

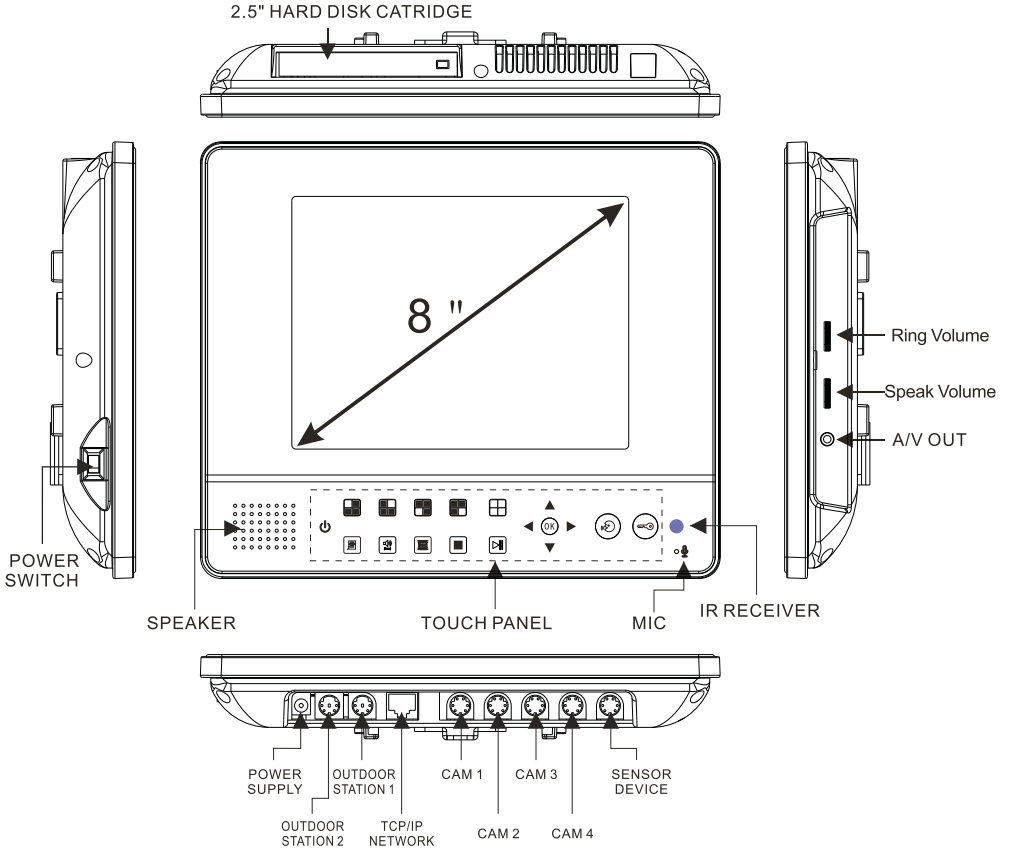

Fig.2

• Camera

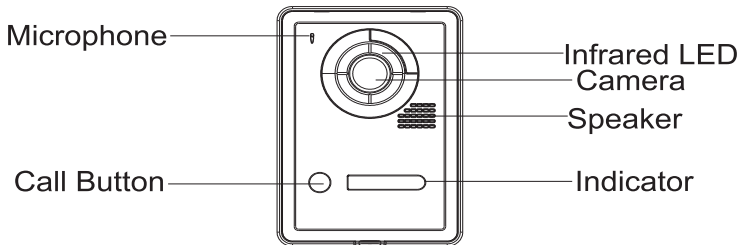

Fig.3

2.3 Preparation before installation

1. Please prepare necessary cables for connection and a 2.5" SATA hard disk.
2. Please ensure for safe operation of the device with required ventilation and keep it away from humid environment.
3. Make sure there is enough space for all connection cables. Cable bending radius should not be less than 5 times of the cable diameter.

2.4 Insert the hard disk

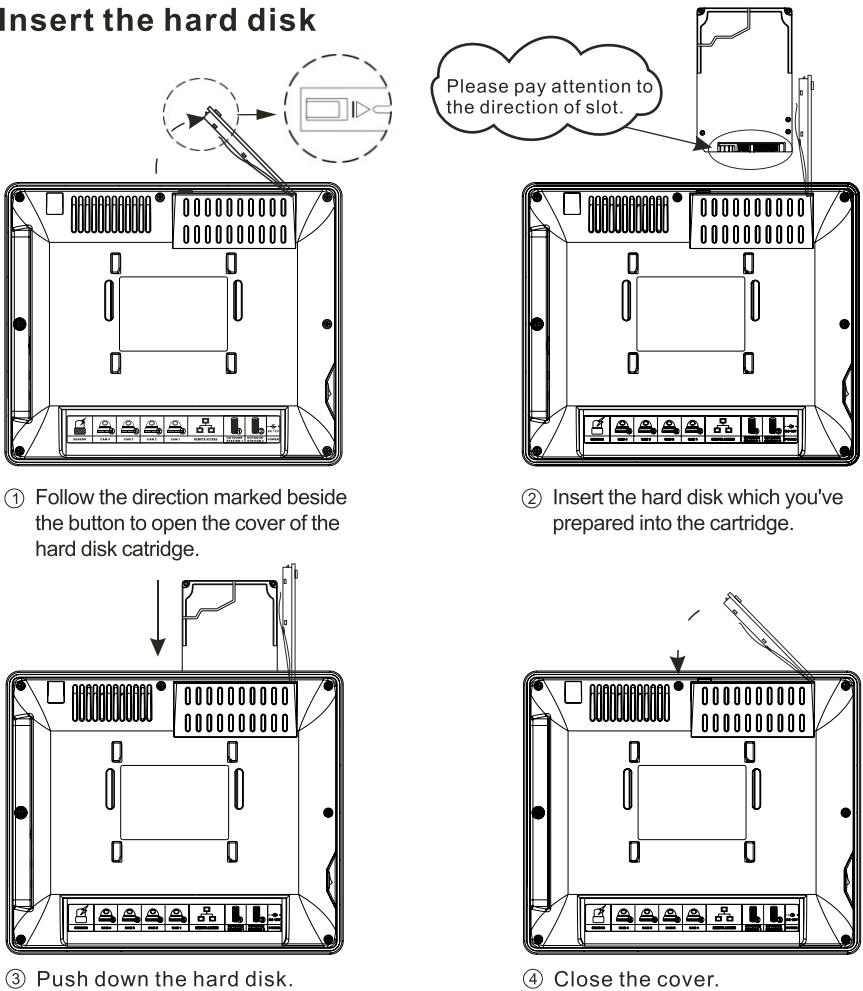
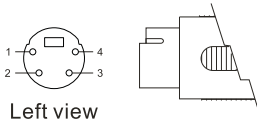

Fig.4

2.5 Installation

• Connectors

4-pin connector for outdoor station



- | | |
|------------------|---------------------|
| 1---- GND(Black) | 2---- Video(Yellow) |
| 3---- B+(Red) | 4---- Audio(White) |

5-pin connector for alarm device

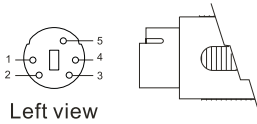

- | | |
|-----------------------|-----------------------|
| 1---- Alarm Out(Blue) | 2---- Alarm In(Brown) |
| 3---- Sensor 2(White) | 4---- Sensor 1(Red) |
| 5---- GND(Black) | |

6-pin connector for camera

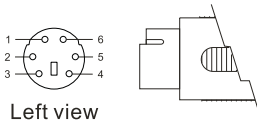

- | | |
|------------------------------------|------------------------|
| 1---- GND for Video(Black) | 2---- Control(Blue) |
| 3---- GND for Audio & Power(Brown) | |
| 4---- VDD(Red) | 5---- Video In(Yellow) |
| 6---- Audio In(White) | |

Fig.5

• Wiring

One monitor to two cameras

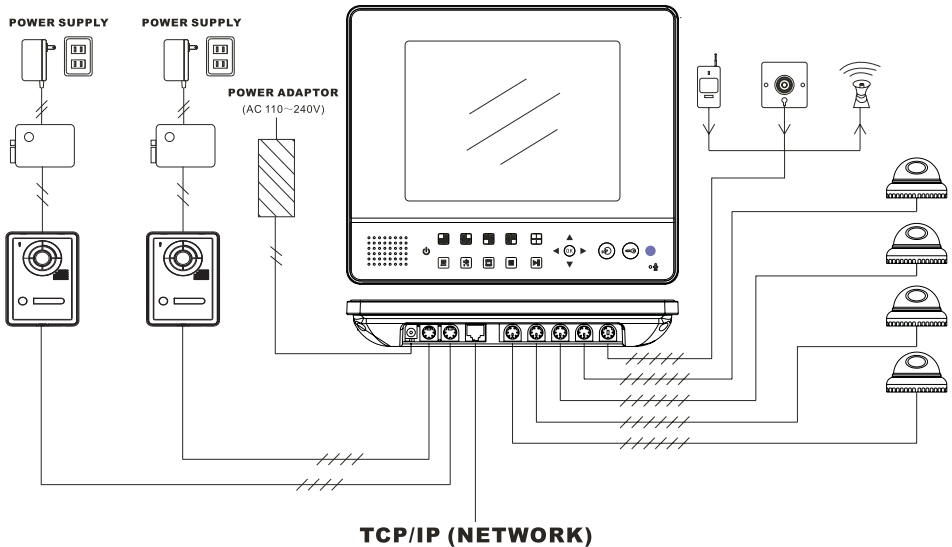

Fig.6

- **Wall-mounted installation of the monitor**

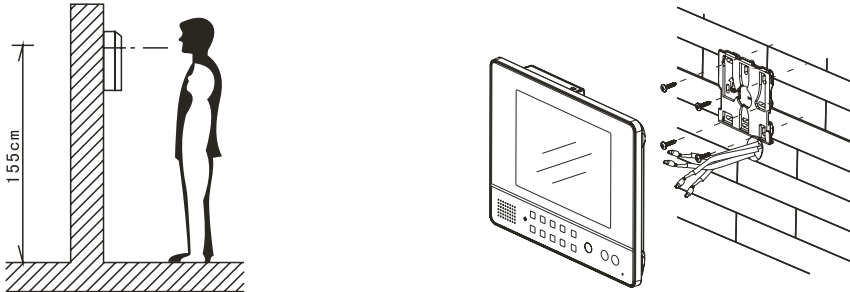
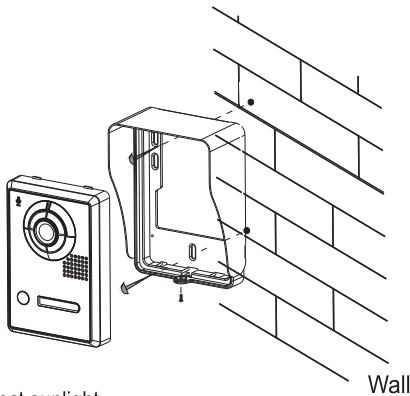
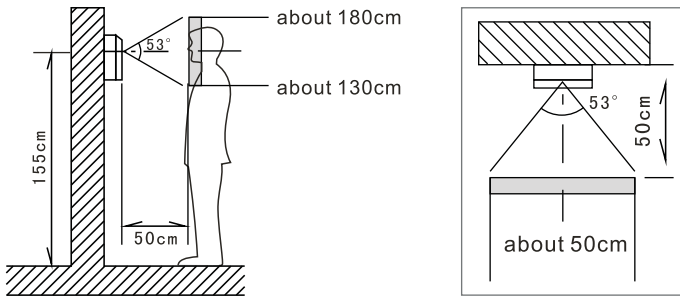

Fig.7

- > Fix the wall-mounted bracket on the wall with 4 screws, then hang up the monitor on the bracket.
- > The optimum height for the monitor to be installed is 130cm~150cm from the ground.

- **Installation of the outdoor unit**



Notice:

Keep the camera away from direct sunlight and the effects of poor weather .

Fig.8

Notice:Please keep the outdoor unit away from snow, rain and direct sunlight.

CHAPTER 3 OPERATION

3.1 How to turn on/off

• Turn On

1. Push the power switch on the left side of the indoor unit, the monitor will start.
2. The monitor shows quad monitoring at start up as shown in Fig.10 after system check.







Fig.9

3. If the time is within schedule recording time, the system will automatically start the schedule recording approximately 10 seconds after the boot up as shown in Fig.11.



Fig.10

5. Description of display

C1,C2, C3,C4	Channel number of CCTV cameras.
D1,D2	Channel number of doorstation cameras.
	Video recording status. Red dot means recording.
	Channel with audio input. Red icon means recording and white one means no recording. The recording status can be changed in the SETUP->AUDIO PORT->RECORDING.
	Outputting audio information. One channel audio can be outputted by the microphone of the monitor. The user can press  to select one channel audio to be outputted or close the audio outputting.
A-REC	Always recording.
S-REC	Sensor recording.
N-REC	No recording.
75%	Used space of hard disk. "" means that the disk is in overwriting status.
DATE/TIME	System date/time.

Note: Your previous settings of the monitor will remain the same when it's restarted from power cut or shut off.

• Turn Off

1. Press the stop button  to stop recording.
2. Push the power switch on the left side of the indoor unit, the monitor will turn off.

3.2 Operation buttons

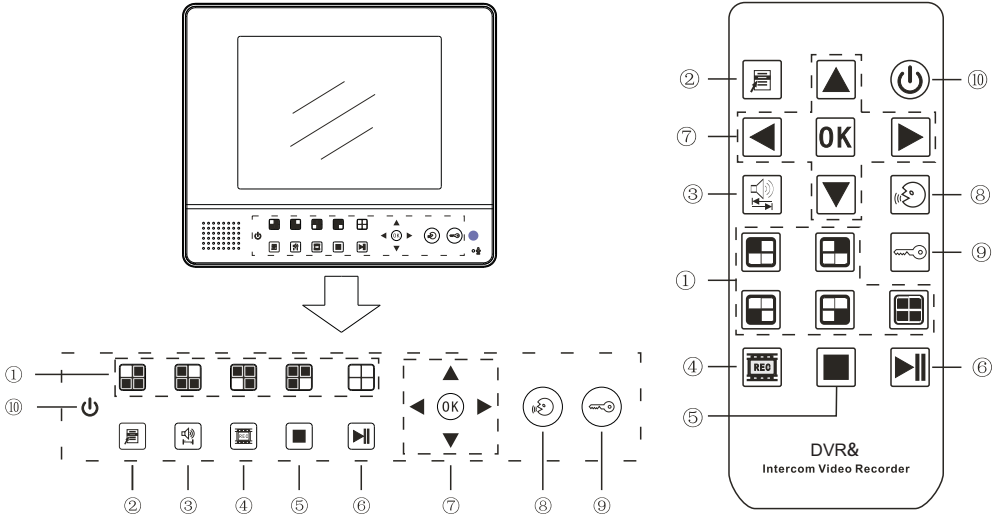



Fig.11

NO.	NAME	ICON	OPERATION	NO.	NAME	ICON	OPERATION		
1	Display		Full Screen Display of Channle 1/Number 1	6	Play		Play/Pause		
			Full Screen Display of Channle 2/Number 2			7	Move/ Confirm		Up
			Full Screen Display of Channle 3/Number 3						Down
			Full Screen Display of Channle 4/Number 4						Left/Backward
			Quad Display						Right/Forward
2	Setup		Enter/Exit Setup				Choose/Confirm		
3	Audio Channel		Switch/Close Audio Output	8	Talk/ Monitoring		Talk/Monitoring		
4	REC		Start Recording	9	Unlock		Unlock		
5	Stop		Stop	10	Display On/Off		Turn On/Off Monitor Display		

Note: Buttons on the remote controller are same functions as on monitor buttons.

CHAPTER 4 SETUP

To enter SETUP menu, press the stop button  , then press  . The following screen will display:

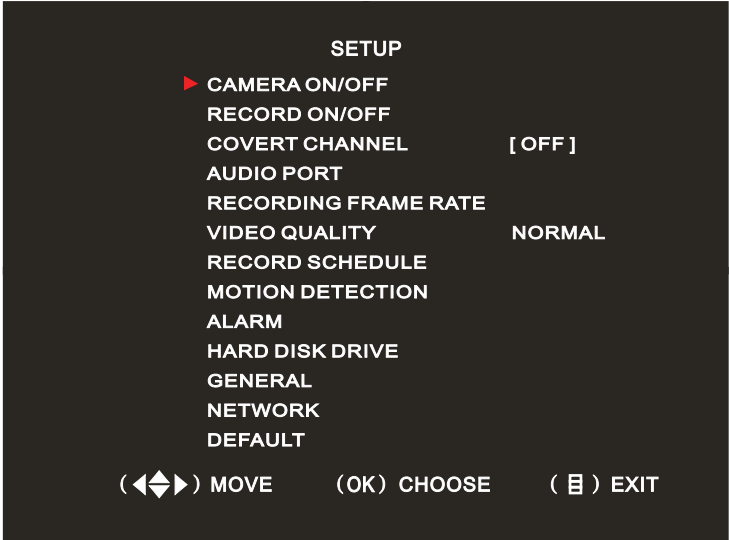

Fig.12

4.1 CAMERA ON/OFF

Each channel can be set ON or OFF. If set to OFF, the corresponding screen goes black and recording function is disabled. Default is ON.

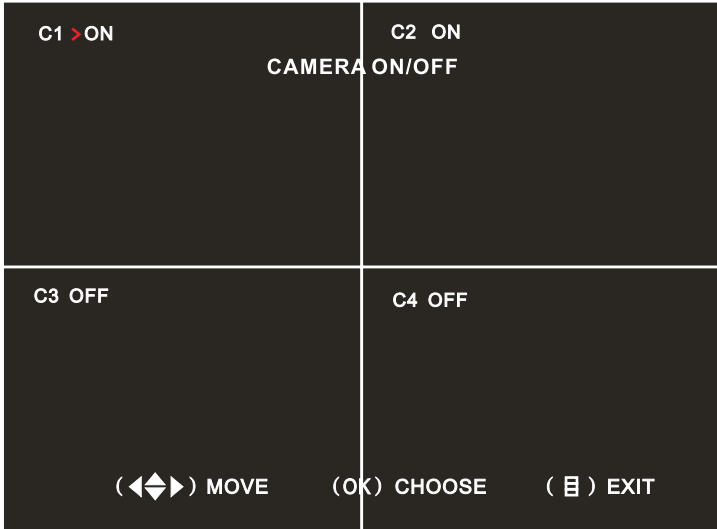

Fig.13

Press ▲、▼、◀、▶ to move the red ► to select the channel, then press OK to set the camera connected to this channel to be ON or OFF.

4.2 RECORD ON/OFF

Video recording function of each channel can be enabled or disabled separately. If it is set to OFF, the screen will keep showing the surveilled scene, but it will not be recorded.

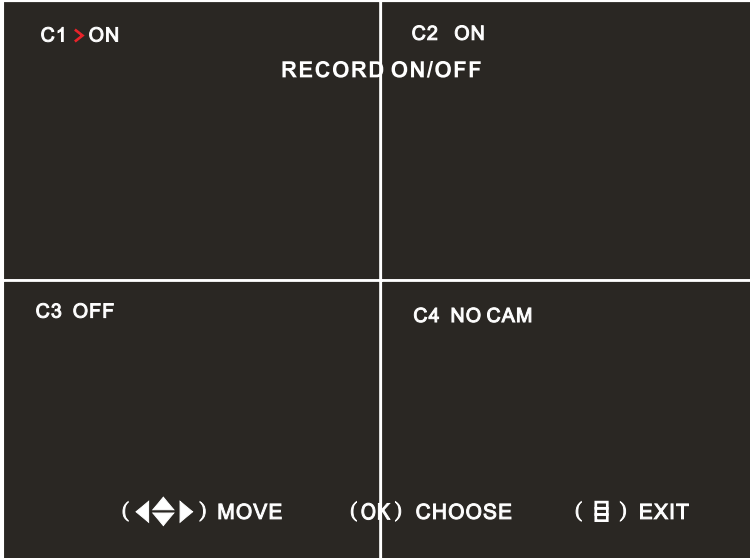

Fig.14

Press ▲、▼、◀、▶ to move the red ► to select the channel, then press OK to set recording function ON or OFF.

NO CAM means there is no camera being connected with the corresponding channel of the monitor.

4.3 COVERT FUNCTION

You can choose one channel to be covert. This covert channel will not be shown on the screen, but it can be recorded.

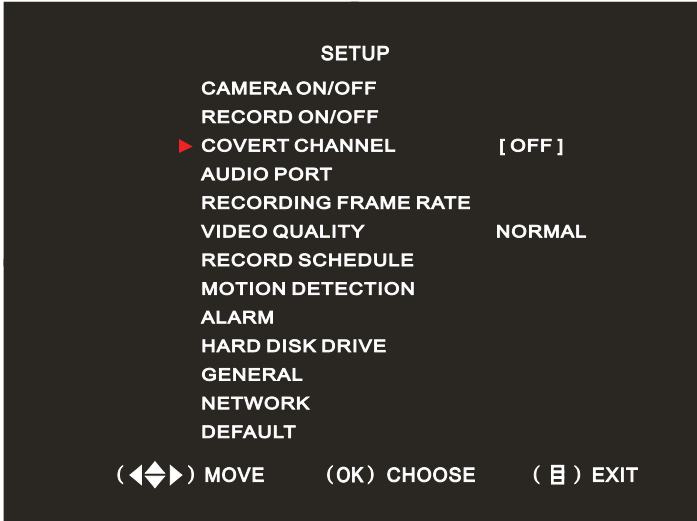

Fig.15

4.4 AUDIO PORT

Two channels of audio input are available. Audio acquisition devices can be connected to any two video channels. Users can enable or disable recording of audio separately by setting the RECORDING.

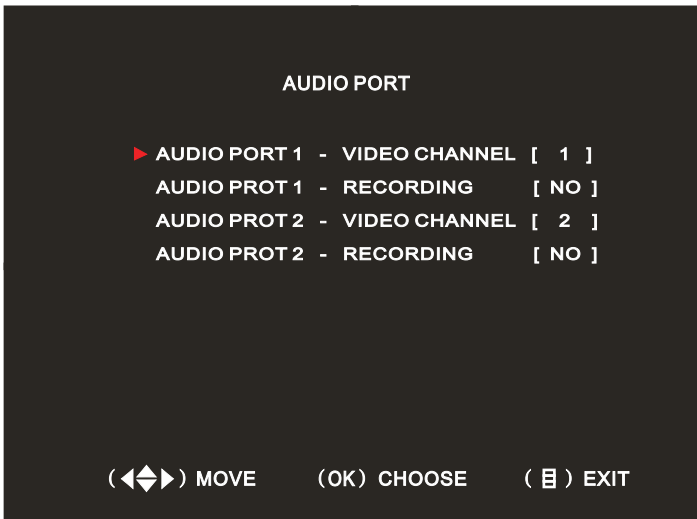

Fig.16

4.5 RECORDING FRAMET RATE

Frame rate of each channel can be separately set to 1,2,3,4,5,6,12,16,25 FPS. Total frame rate of four channels is 50 FPS for PAL TV system and 60FPS for NTSC TV system. For example, if you set 16FPS for channe 1, channel 2 and channel 3 for a monitor in PAL TV system, you can choose 1FPS or 2FPS for channel 4 and keep the selected recording frame rate of other channels same, however, if you want to set the frame rate of channel 4 to a option more than 2FPS, the frame rate of other channels will be reduced automatically.

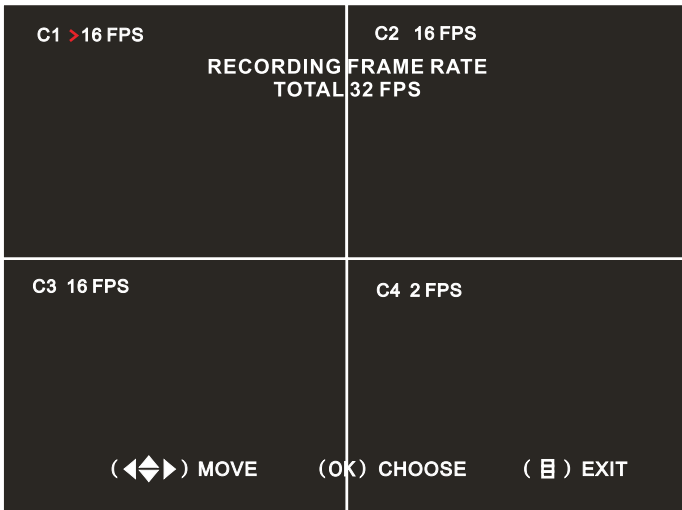

Fig.17

Press 、、、 to move the red to the channel to be set, then press to set the recording frame rate of this channel to a proper value.

4.6 VIDEO QUALITY

There are three options(HIGH, NORMAL and LOW) for video quality of recording. The better recording quality you choose, the more disk space it takes.

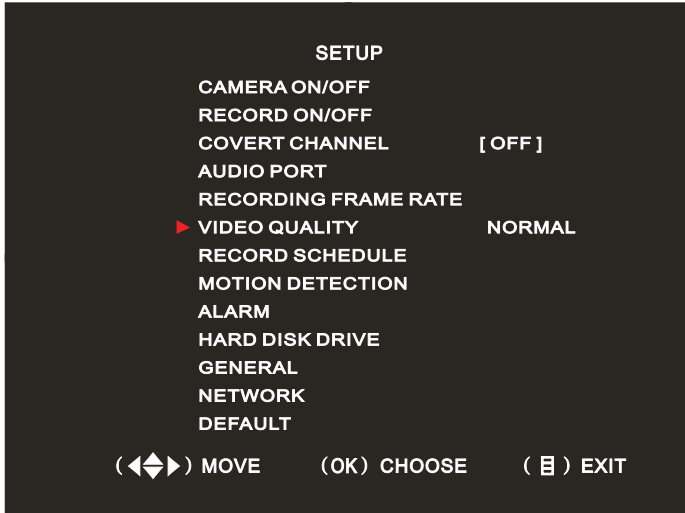

Fig.18

Press **OK** button to select a preferred video quality of recording .

4.7 RECORDING SCHEDULE

Users can schedule the recording hour by hour for the whole day. The three options of recording are as following,

- > **NO RECORDING:** Video will not be recorded.
- > **ALWAYS RECORDING:** Video will be always recorded.
- > **SENSOR RECORDING:** Video will be recorded when motion is detected or an alarm event occurs.

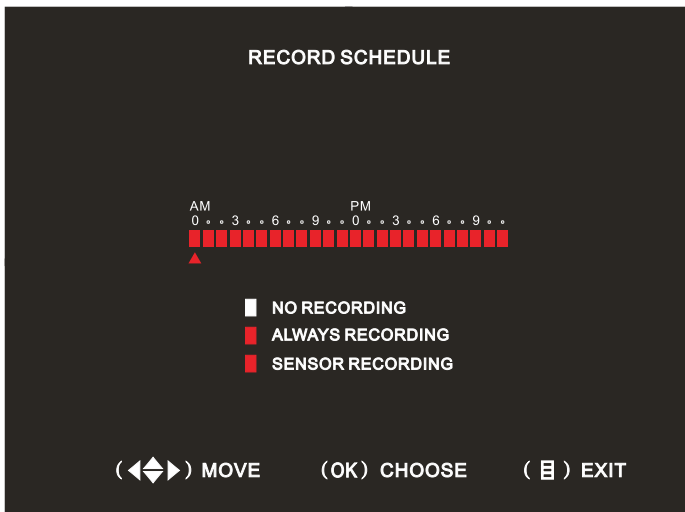

Fig.19

Press ▲、▼、◀、▶ to move the red ▲ to select the time frame, then press OK to set the recording mode.

4.8 MOTION DETECTION

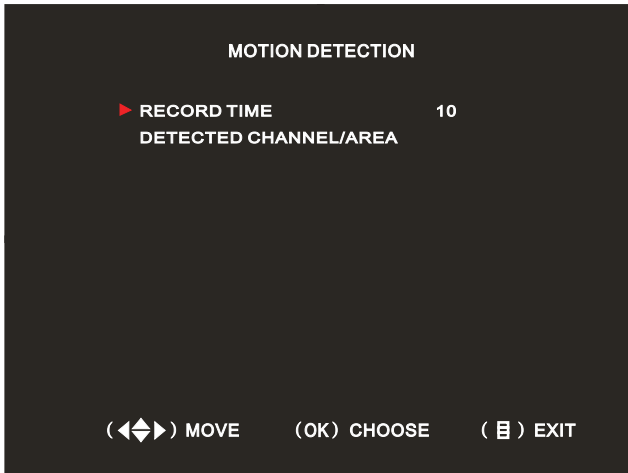

Fig.20

- **RECORD TIME**

Set the recording time when a motion event occurs in the SENSOR RECORDING mode.

- **DETECTED CHANNEL/AREA**

Users can turn ON or OFF the motion detection function of each channel . Press ▲ or ▼ to move the red ▶ to select the channel, then press OK to set the motion detection ON or OFF.

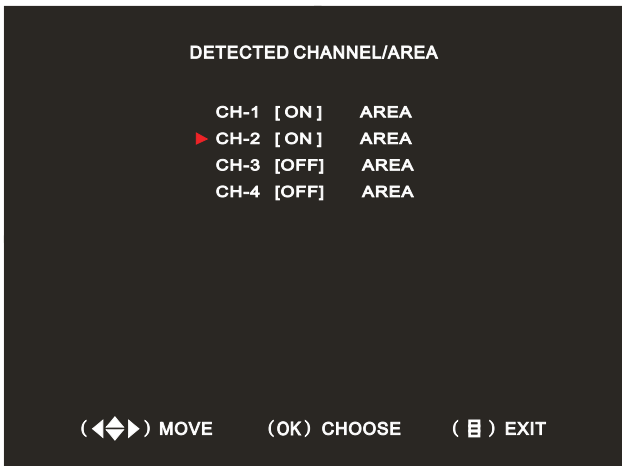

Fig.21

4.9 ALARM SETUP

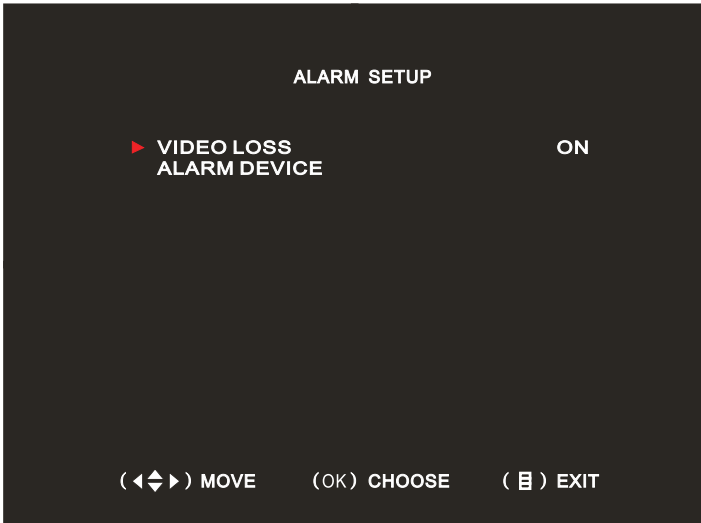

Fig.24

- **VIDEO LOSS**

In the monitoring status, if the video cable connection is not good, the indoor unit will alarm with beep sound. Users can set it ON or OFF.

- **ALARM DEVICE**



Fig.25

> **Alarm sensor setting:** You can connect 2 alarm sensors with the monitor and set them to be bonded with 2 of the 4 CCTV channels. If an external alarm sensor is connected and it's triggered by an event, the monitor will alarm with beep sound and also activate the recording if it's in SENSOR RECORDING schedule. If you have connected with an external alarm output device, it will send an alarm. Users can also enable or disable the connected alarm sensors by setting them OPEN or CLOSE.

> **Alarm Time:** It's for setting the time of alarm outputting when an alarm event occurs. OFF means no response to the alarm event and CONT means constantly response to the alarm event till someone stop it manually.

4.10 HARD DISK DRIVE



Fig.26

- **HDD information**

- > **ST9408221AS:** Hard disk model. It is different from model to model.

- > **HDD CAPACITY:** The capacity of current hard disk.

- > **HDD USED:** The occupation of hard disk space.

- **OVERWRITE ENABLED**

- If it is set to YES, the system will automatically overwrite the earlier footage when the storage is full.

- **FORMAT HDD**

Format the current hard disk. Password set in the GENERAL is required for formatting the hard disk and the initial password is 111111 (press  6 times).

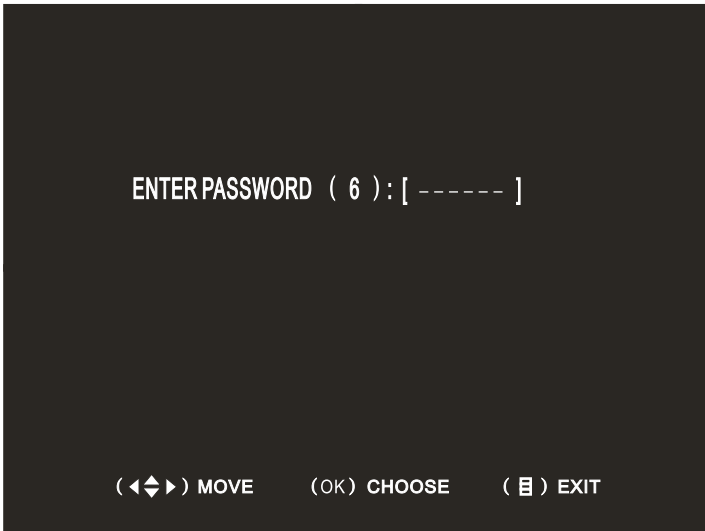

Fig.27

4.11 GENERAL

To set system-related issues.

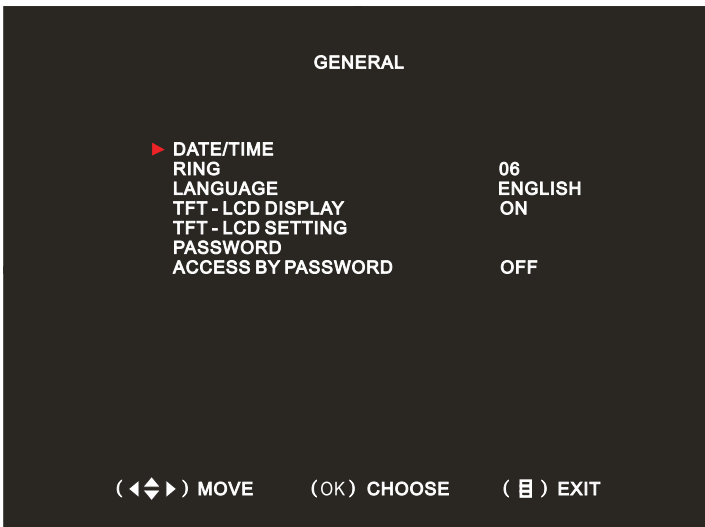

Fig.28

- **DATE/TIME:** Set the system time.

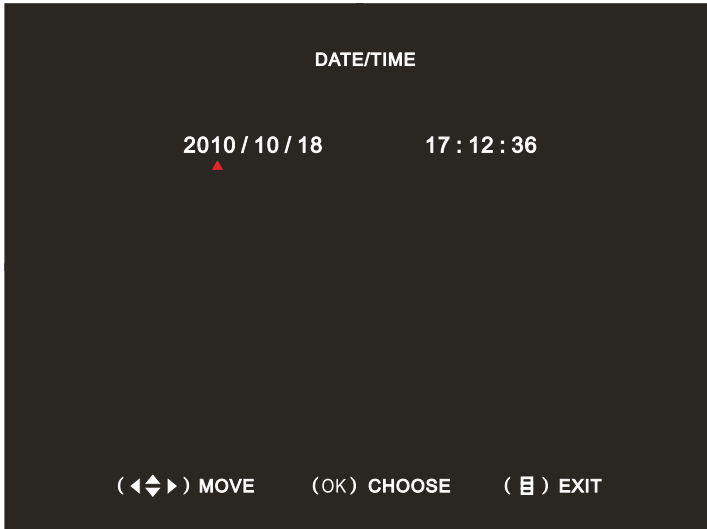

Fig.29

Press ◀ or ▶ to move the red ▲ to the digit which you are going to change, then press OK to change the numbers.

- **RING:** You can choose a preferred ring for visitors calling. There are total 8 options.
- **LANGUAGE:** Chinese and English are available.
- **TFT-LCD DISPLAY:** When it's set to ON, the screen will be always lighting, and if it's set to OFF, the screen will be turned off in normal, but it will be activated when there is a call. Users can press button ⏏ to change the status.
- **TFT-LCD SETTING:** Users can adjust **BRIGHTNESS**, **CONTRAST** and **SATURATION** of the screen display to a proper value.

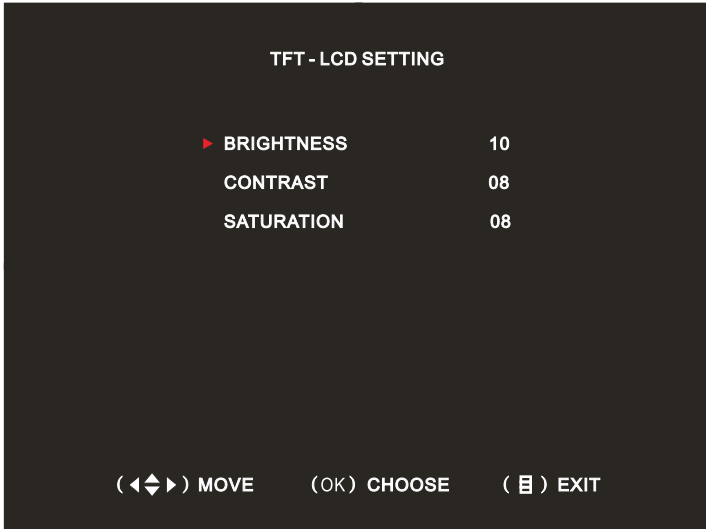







Fig.30

- **PASSWORD:** Users can change password. The length is fixed to 6 digits,  stands for 1,  stands for 2,  stands for 3,  stands for 4. The initial password is 111111 (press  6 times).

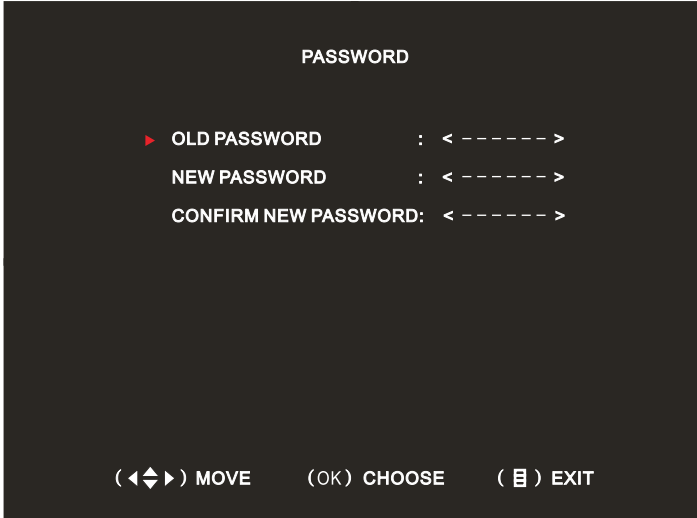

Fig.31

Note: You can press  to delete it when you enter a wrong digit.

- **ACCESS BY PASSWORD:** The user must enter the password before any further operation. Default setting is OFF.

4.12 DEFAULT

The initial password is "111111". The password and network setting will not be changed after default setting.

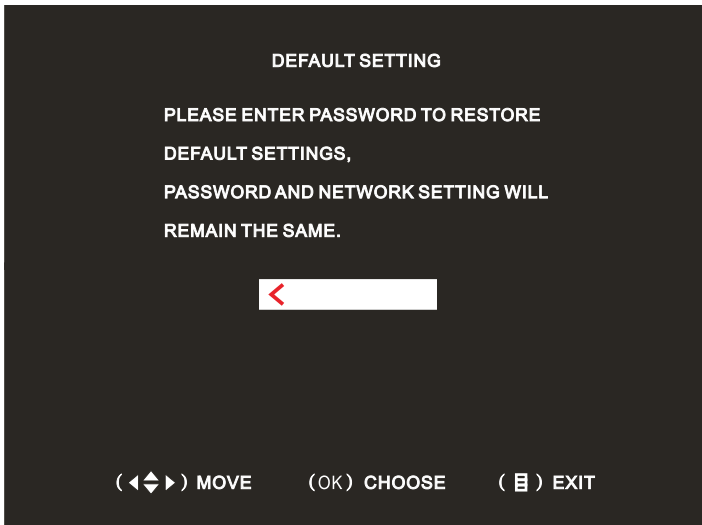





Fig.32

CHAPTER 5 NETWORK

5.1 Basic setting of Network

Connect the monitor to the network. Press  to enter the SETUP menu. Use  and  button to select NETWORK, then press  to enter the NETWORK menu. The screen will display as Fig. 34.

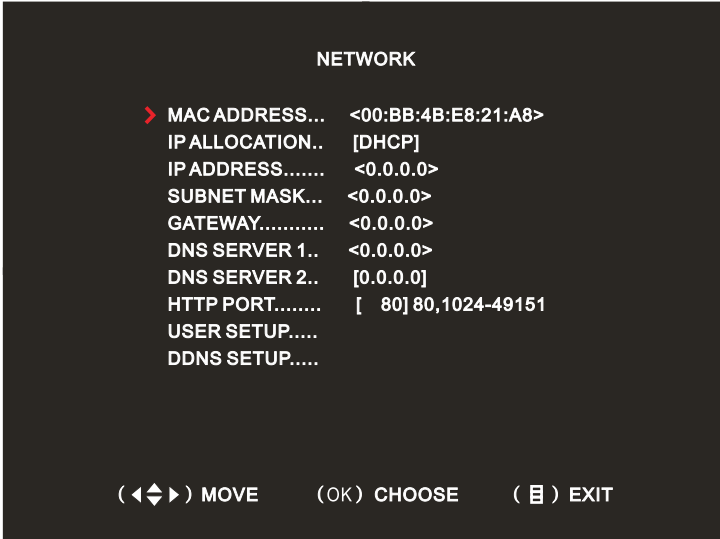









Fig.33

- **MAC ADDRESS:** It is a unique identifier assigned to network interfaces for communications on the physical network segment.
- **IP ALLOCATION:** Supports both DHCP(dynamic) and STATIC IP.

1) DHCP IP SETTING

If DHCP is selected, **IP ADDRESS**, **SUBNET MASK**, **GATEWAY** and **DNS SERVER 1** will be obtained from the DHCP server automatically. Users can set the **DNS SERVER 2** optionally.

- **DNS SERVER 2**

Press  or  to move  to the digit to be set, then press  or  to move  to the corresponding digit and press  to choose it. Repeat this step until the **DNS SERVER 2** is set correctly.

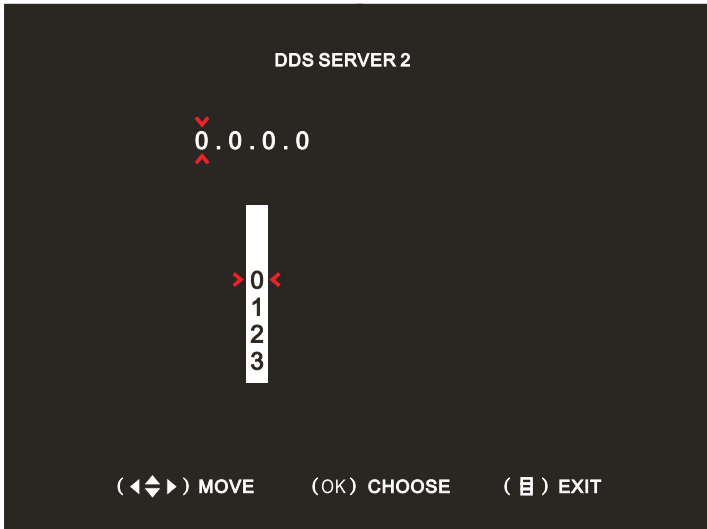

Fig.34

Note: To guarantee the stability of the IP address in the LAN. It's recommended to obtain the IP automatically by DHCP mode and write down your current IP address, then change IP allocation to static and enter IP information in the network setting.

2) STATIC IP SETTING

If **STATIC IP** is selected, users should set **IP ADDRESS**, **SUBNET MASK**, **GATEWAY** and **DNS SERVER 1** manually. **DNS SERVER 2** can be set optionally.

• IP ADDRESS

Press or to move **X** to the digit to be set, then press or to move **> X** to the corresponding digit and press to choose it. Repeat this step until the **IP ADDRESS** is set correctly.

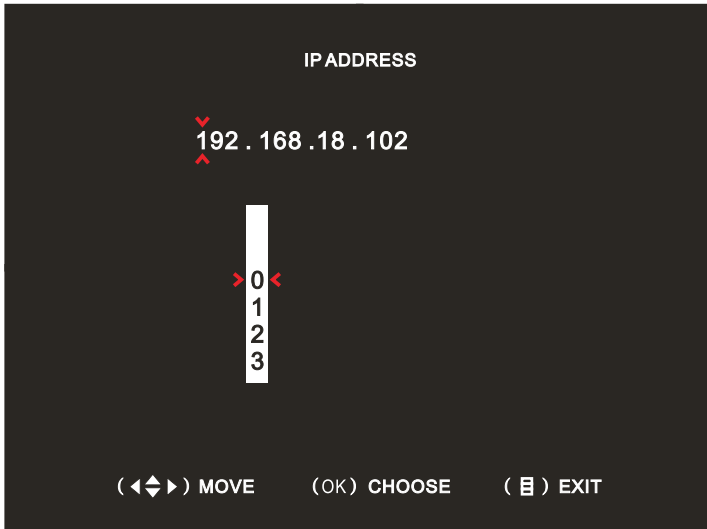

Fig.35

• SUBNET MASK

Press or to move **X** to the digit to be set, then press or to move **><** to the corresponding digit and press to choose it. Repeat this step until the **SUBNET MASK** is set correctly.

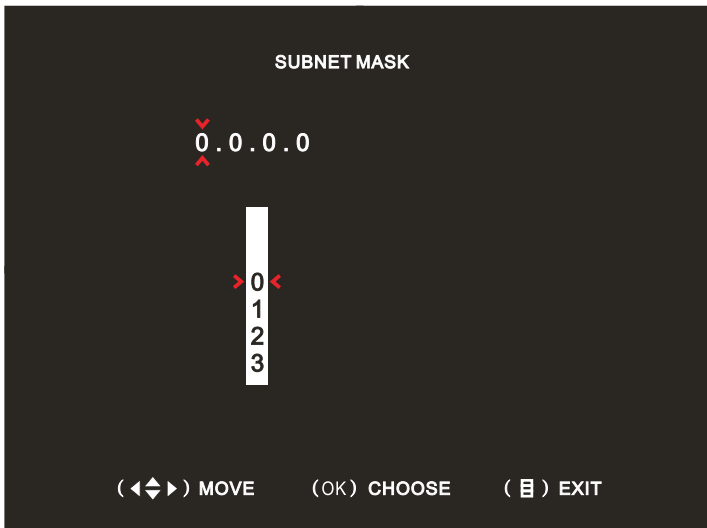

Fig.36

- **GATEWAY**

Press or to move to the digit to be set, then press or to move to the corresponding digit and press to choose it. Repeat this step until the **GATEWAY** is set correctly.

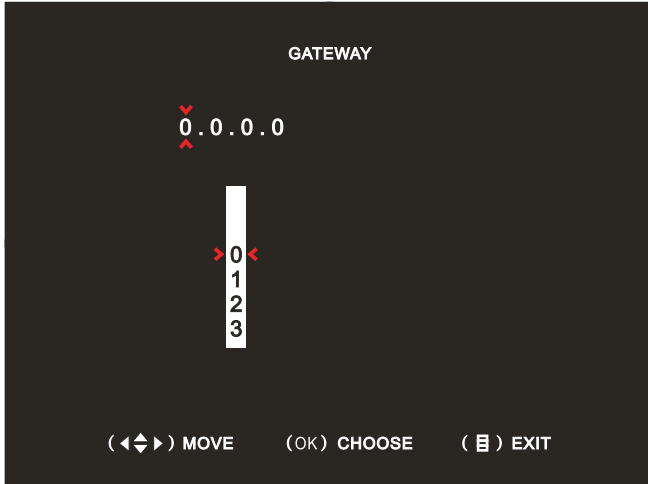

Fig.37

- **DNS SERVER 1**

Press or to move to the digit to be set, then press or to move to the corresponding digit and press to choose it. Repeat this step until the **DNS SERVER 1** is set correctly.

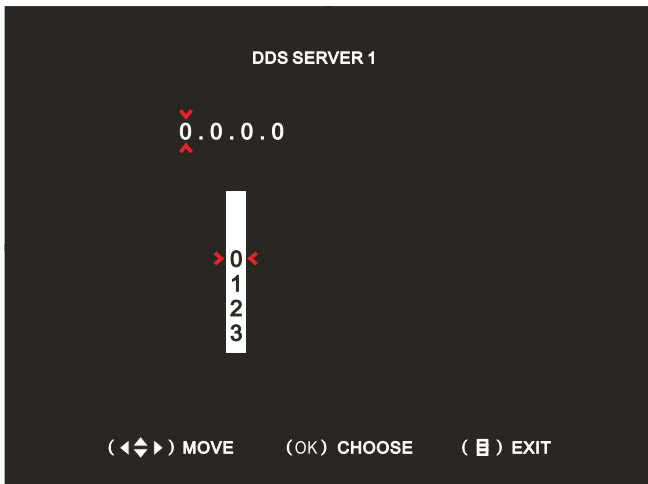

Fig.38

• DNS SERVER 2

Press ◀ or ▶ to move ✕ to the digit to be set, then press ▲ or ▼ to move >< to the corresponding digit and press OK to choose it. Repeat this step until the **DNS SERVER 2** is set correctly.

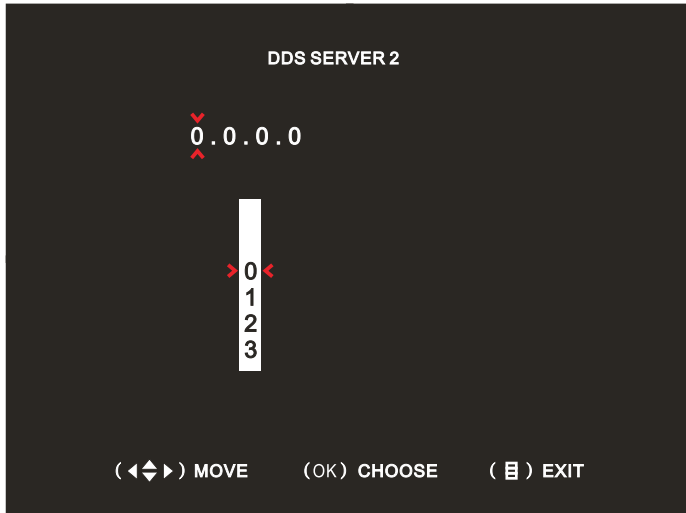

Fig.39

Note: Please restart your monitor after network setup.

5.2 Open HTTP port

It's necessary to open the HTTP port of the monitor before the users can get remote access to it.

1. Assign a port number to be opened

Optional HTTP PORT is 80,1024 to 49151. Press ▲ or ▼ to move >< to the digit to be set, then press ◀ or ▶ to move ✕ to the corresponding digit and press OK to choose it. Repeat this step until the **HTTP PORT** is set correctly. The default port is 80.

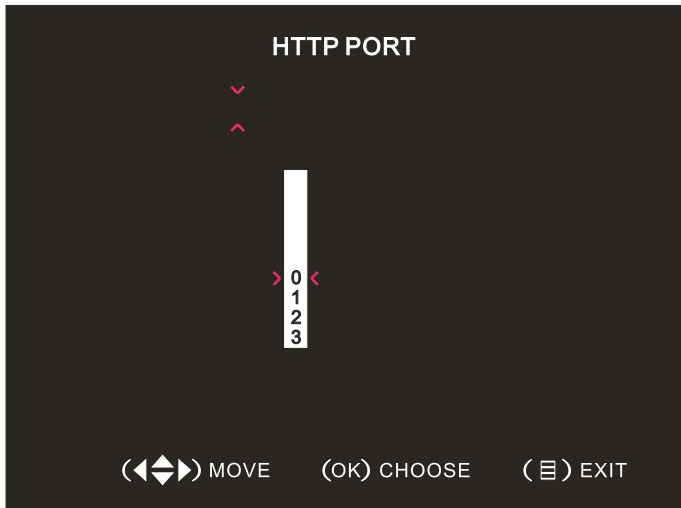

Fig.40

2. Open the HTTP PORT on a router

It might be done in different way to open an HTTP PORT on different types of routers. For a specific router, please contact the vendor to get the detail.

5.3 Remote monitoring and control

1. Open an IE browser, enter the monitor's IP address such as `http://192.168.18.101:6666` in the LAN or your WAN IP such as `http://113.110.152.49:6666` in the address bar. First visit will be prompted to install plugin, select "Yes" to install it. Installation will begin automatically after downloading. If the plugin does not download automatically, please click "Download" in "If the plugin can not download, click here". Double click the downloaded file to install it when the download is finished.

Note: The port number can be omitted if you use the default port 80, for example `http://192.168.18.101`.

2. After the plug-in installation, it will pop-up a "Remote Client" window as Fig.42 shows. If not, please close and restart IE then input the network address correctly.

Remote Client

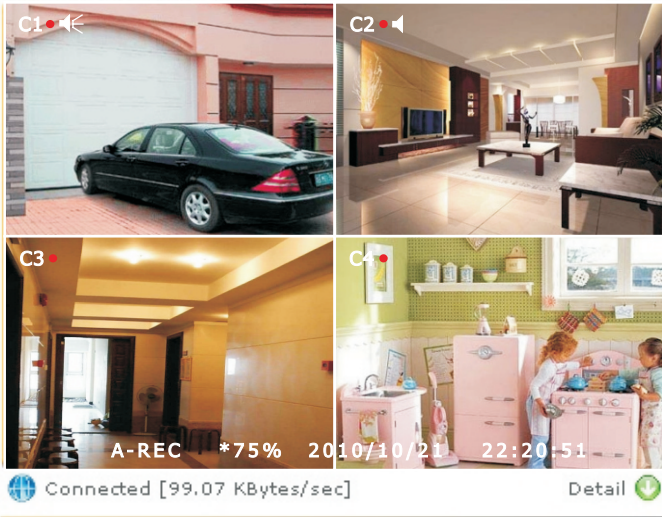

Remote Client - ver. 3.0.0

Fig.41

3. If the remote client does not show the monitored scene, please lower the security level of your browser. Open Internet Explorer browser, select "Tools" - "Internet Options" - "Security" - "Internet" - "Custom Level". In the popup window, open all the ActiveX plugins and controls.

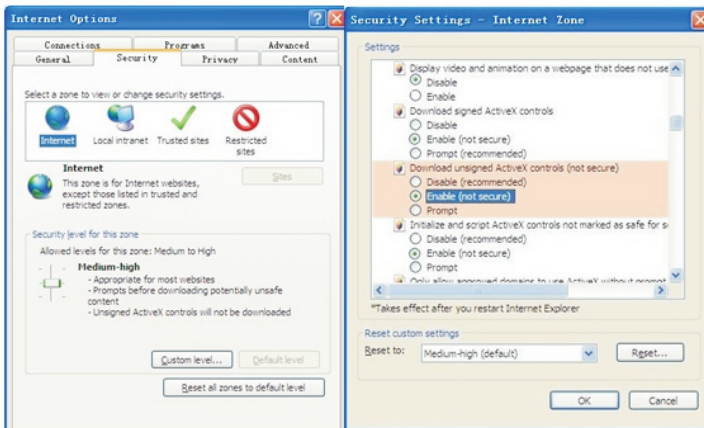

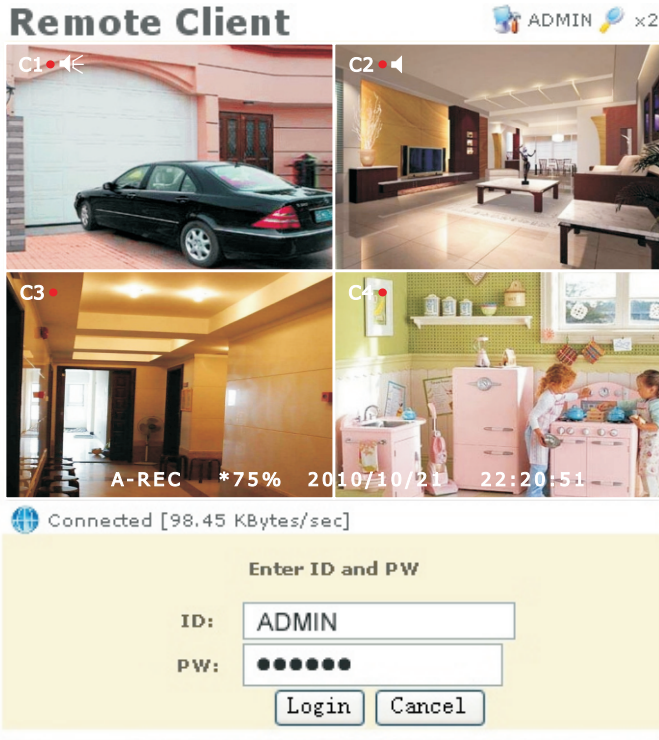

Fig.42

4. Click  x2 to enlarge the preview screen two times.

5. Click  , input user ID and password will appear at the bottom of the Remote Client window. Users can log in for further control. There are two types of users for remote access. One is administrator which has full operating rights and another is normal user which can view the monitored scene only.



Remote Client - ver. 3.0.0

Fig.43

Note: The user name and password are all in capital letters. Both default ID and default password are ADMIN.

6. Tools and control of the Remote Client

Remote Client



Remote Client - ver. 3.0.0

Fig.44

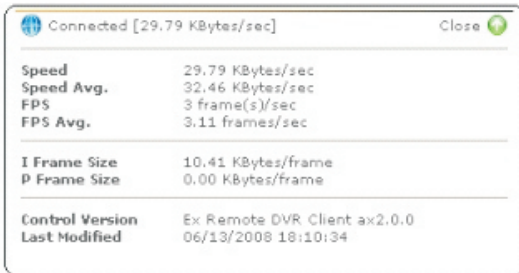

Fig.45

- **Connected**
Current connection status.

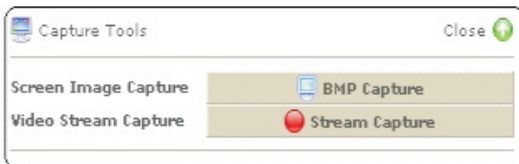

Fig.46

- **Capture Tools**
For capturing images and video.



- Remote IVR Control Panel
Remote control to your monitor.

Fig.47

5.4 DDNS setup

To setup Dynamic Domain Name Service. The user is required to register and create a host name from the DDNS service provider WWW.DYNDNS.COM. Then enter user ID(user name), password and domain name obtained in the DDNS SETUP of the monitor.

1. Visit website [http:// www.dyndns.com](http://www.dyndns.com).

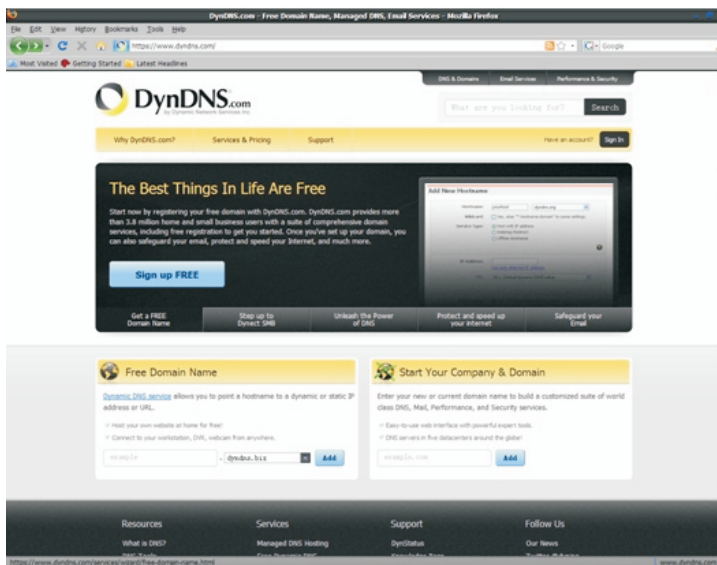

Fig.48

2. Sign up an account and create a host name such as *remoteview.dyndns-free.com*.

3. DDNS Setup in the monitor

Enter the host name, Username and Password you obtained from the DDNS service provider in the DOMAIN NAME, USER ID and PASSWORD of the DDNS SETUP menu as Fig.50 shows.

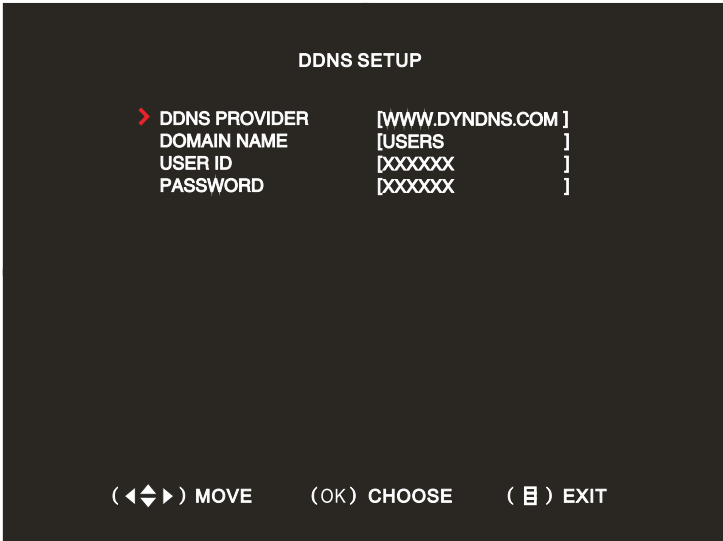
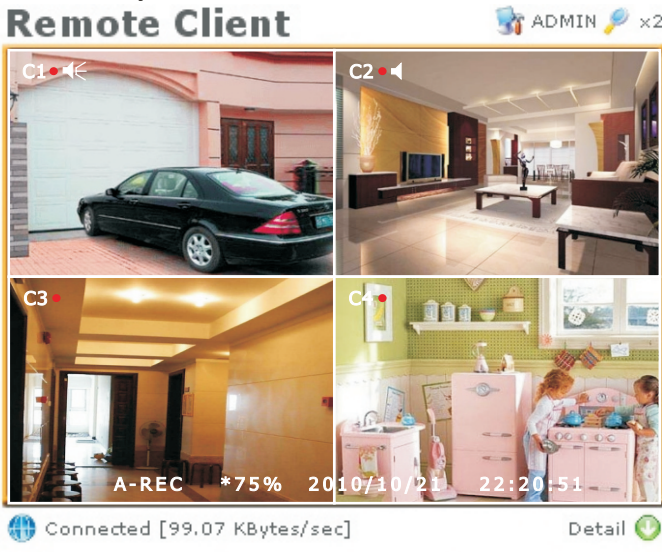

Fig.49

4. Enter <http://remoteview.dyndns-free.com:6666> in your browser to get remote access to your monitor.



Remote Client - ver. 3.0.0

Fig.50

CHAPTER 6 VIDEO PLAYBACK

6.1 Playback on monitor







Press the stop button , then press the play button , the system will automatically play the latest video clip.



Fig.51

Press the menu button  to enter the VIDEO SEARCH menu. Users can search video by event or time.

- **Search video by EVENT**

Press  or  to select the search type EVENT (four options: ALL, D, A, S), then press  to choose it. The display will change to Fig.53 shows.

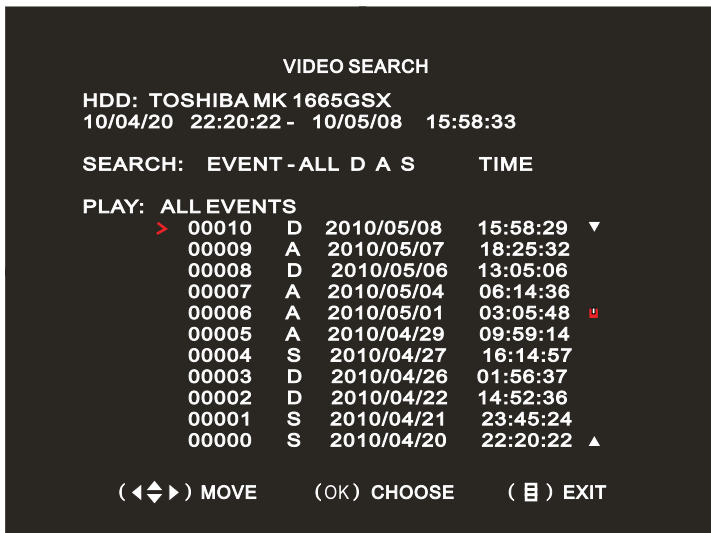

Fig.52

Users can press ▲ or ▼ to select from different events, and press ▶ to play. In the event list, "A" stands for video clip recorded in always recording mode, "S" stands for video clip recorded in sensor recording mode and "D" stands for video clip recorded when a visitor call.

When a ■ appears on an event, it presents that this event is accompanied by power failure.

• **Search video by TIME**

Press ◀ or ▶ to select the search type TIME, then press OK to choose it. The display will change to Fig.54 shows. Users can input the time which he wants to check the video and press ▶ to play.

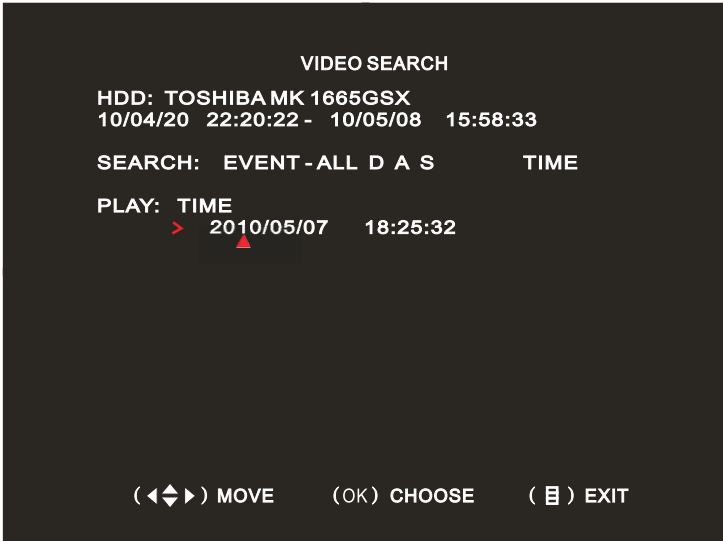





Fig.53

6.2 Playback with PC

Take out the hard disk from your monitor and connect it with a computer. The format of recorded footage is ".MCG". It requires a special software to play it. Insert the CD provided with the package to the CD driver of the computer and open the software . Click  to open the recorded footage. Then click  to play the video.

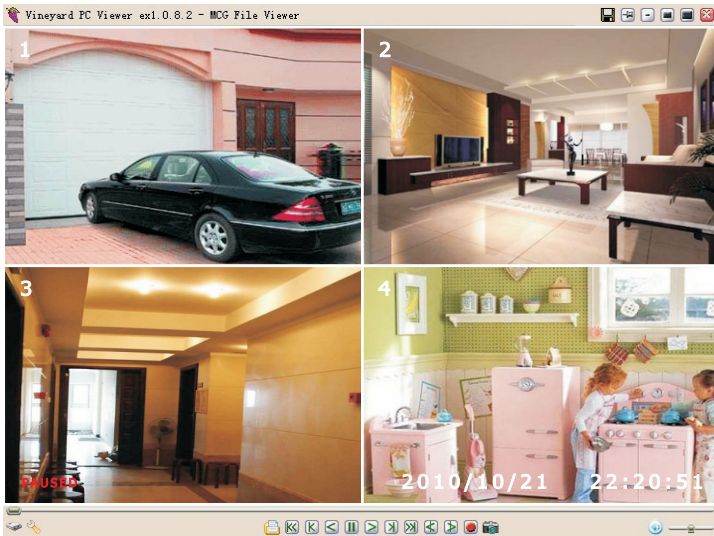





















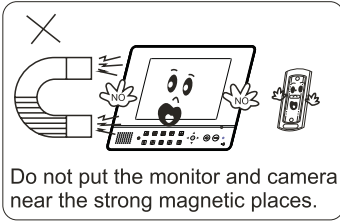

Fig.54

Operation instruction

	MCG file dump		Reverse Playback
	Always Top Window		Pause
	50% Screen		Forward Playback
	100% Screen		Jump forward 10 Sec
	150% Screen		Jump forward 60 Sec
	Close		Play frame by frame backward
	Open another MCG file		Play frame by frame forward
	Jump back 60 Sec		Record
	Jump back 10 Sec		Capture [BMP]
	Switching storage device.		
	Preferences Change the application's default setting.		
	Audio Output Setting / Volume control		
Move the window	Drag the window by its part below title bar to move it.		

CAUTION



1



2

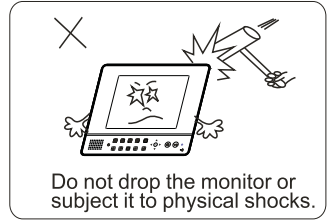

3

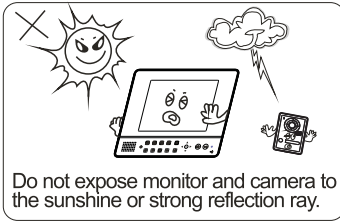

4

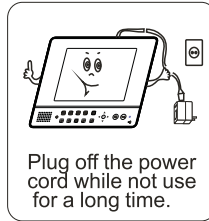

5

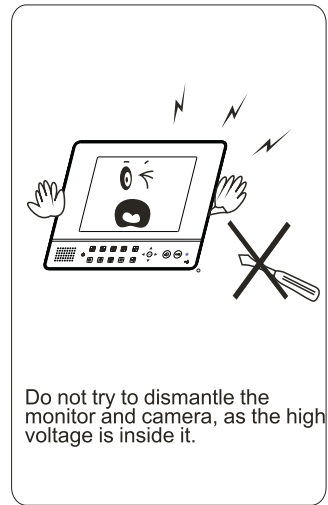

8

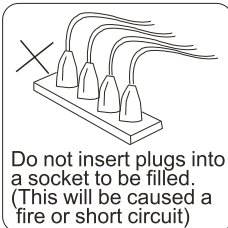

6

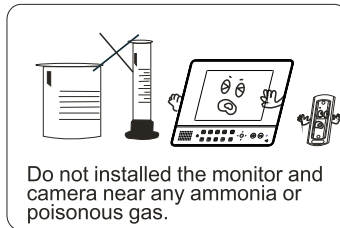

7

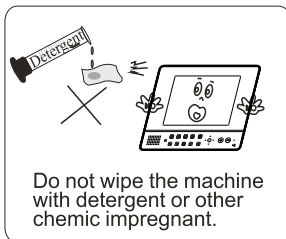

9

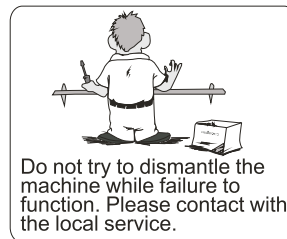

10