

# ***POWERTECH***



## Operating Manual MP-3739

## **About this manual**

These operating instructions come with the product and should be kept for the life of the product for proper installation and usage.

- Read these operating instructions carefully before use,
- Keep them for the entire life of the product,
- And pass them on to any future owner or user of this product.

This manual describes the installation, function, operation and maintenance of the solar system controller MP-3739. These operating instructions are intended for end customers. A technical expert must be consulted in cases of uncertainty.

## **Safety**

1. The solar controller may only be used in PV systems for charging and controlling Lead-Acid batteries.
2. No energy source other than solar photovoltaic modules may be connected to the solar charge controller.
3. Use only with 12V or 24V nominal voltage solar PV array
4. Do not connect any defective or damaged measuring equipment.
5. Follow general, safety and accident prevention regulation.
6. Never alter or remove the factory plates and identification labels.
7. Keep children away from PV systems.
8. Never open the device.
9. Only one solar array can connect with one controller only.
10. Never touch bare cables ends.

## **Other risks**

### **Danger of fire and explosion**

- ◆ Do not use the solar charge controller in dusty environments, in the vicinity of solvents or where inflammable gases and vapour can occur.
- ◆ No open fires, flames or sparks in the vicinity of the batteries.
- ◆ Ensure that the room is adequately ventilated.
- ◆ Check the charging process regularly.
- ◆ Follow the charging instructions of the battery manufacturer.

### **Battery acid**

- ◆ Acid splashes on skin or clothing should be immediately treated with soap suds and rinsed with plenty of water.
- ◆ If acid splashes into the eyes, immediately rinse with plenty of water. Seek medical advice.

## Fault behaviour

Operating the solar charge controller is dangerous in the following situations:

- ◆ The solar charge controller does not appear to function at all
- ◆ The solar charge controller or connected cables are visibly damaged
- ◆ Emission of smoke or fluid penetration
- ◆ When parts are loose

In these cases immediately remove the solar charge controller from the solar panels and battery.

## Function

The solar system controller, MP-3739 carries the following features:

- ◆ Monitors the state of charge of the battery
- ◆ Controls the charging process
- ◆ Controls the connection/disconnection of loads
- ◆ Make sure Solar system works in proper manner
- ◆ Programmable Bulk and Float charge voltage
- ◆ Night-Light Function
- ◆ Manual load switch with automatic re-start.
- ◆ Two timer schedule programmable
- ◆ MPPT technology, capturing more energy from sun

### **What is MPP tracking (MPPT)?**

MPPT stands for "Maximum Power Point Tracking". This describes a process by means of which the solar module is always operated at the point of maximum possible power. The point of maximum power can vary depending on the operating mode, local conditions, and because it changes in the course of the day.

## Operating the controller

The display shows a variety of system data by symbols and digits. The buttons on the front panel control all settings and display windows.

### **Display and operation elements**

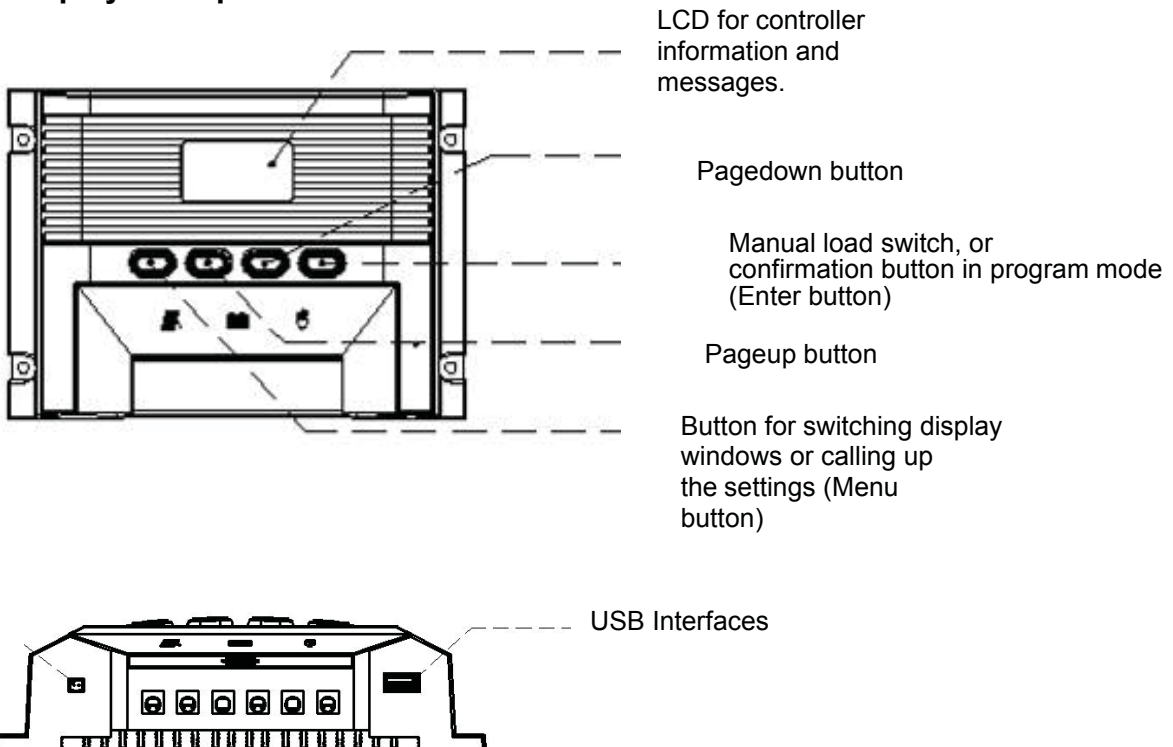

## Display window

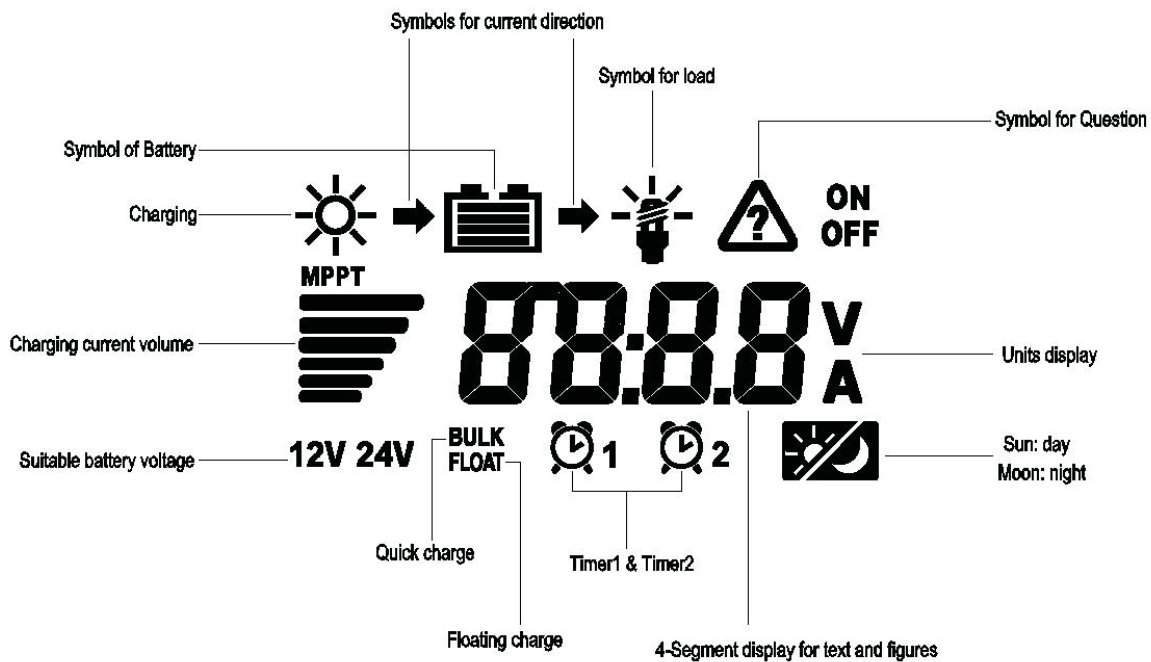

You can change the display windows with the “Menu” button, which provides the following windows:  
**Default window -> Charge current display -> Load current display -> System clock -> Bulk charge voltage -> Float charge voltage -> Night light function (NLF) -> Timer1 -> Timer2 -> Default window**

## Menu Functions and Programming

### Default window

The default window will show battery voltage/capacity volume of the battery, and an overview of the system operation.

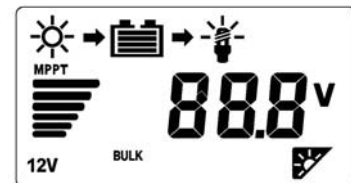

### Manual load control

At the default display window, press the “enter” button to control the load ON or OFF. The load icon will turn display to indicate if the load is turned on or off.



### Charge current

Press “menu” button once to check charging current. (one press from default window)

### Load current

Press” menu” button again to display the load current. (two presses from default window)



When the charging current or load current is less than 0.5Amp, the LCD will always show Min A.

When there is no output for charge current or load current, the display will show 0Amp.



### System clock

From the default display window, press "menu" button 3 times to show controller's system clock.

To set the time, at the system clock window press "enter" button once, the hour will flash. You can adjust the hour via Pageup / Pagedown button. Press "enter" button one more time to confirm the setup for 'Hour' and switch to 'Minute' setup mode. You can adjust the minute via Pageup/Pagedown button. Once it's done, press "enter" button for final confirmation.



### Bulk charge voltage

Press "menu" button 4 times from the default window. Window will switch to BULK voltage programmable setup interface. Press "enter" button once, you can program charge voltage via the Pageup/Pagedown button:

12V Battery(13.8V-14.8V); 24V Battery(27.6V-29.6V)



### Float charge voltage

Press "menu" button 5 times from the default window. Window will switch to FLOAT voltage programmable setup interface. Press "enter" button once, you can program charge voltage via Pageup/Pagedown button:

12V Battery(13.0V-14.2V); 24V Battery(26.0V-28.4V)

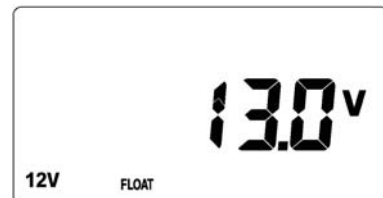

NOTE: When programming the FLOAT voltage, if you press the Pagedown button to go below 13.0V, the LCD will display OFF; meaning that the float voltage is set to ambient temperature control.

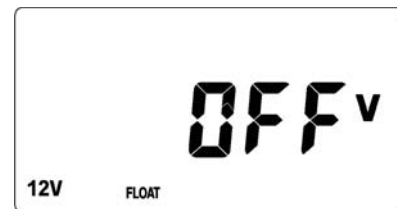

**Night mode**

If solar array can not provide current or the current is less than 1 Amp for 5 minutes or more, the controller will switch to Night mode.

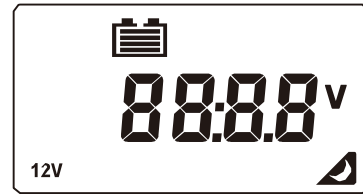

**Night light function**

Press “menu” button 6 times from the default window. Window will switch to NLF setup interface. Press “enter” button once, then using Pageup/Pagedown buttons, choose “ON” or ”OFF” and then confirm with the “enter” button.



**Timer 1, NLF=ON**

With the NLF switched to ON, press “menu” button once from the NLF window, and the window will switch to Timer1 setup interface. Press “enter” button once, you can adjust the “Hour”(1-12hours) via “Pageup/Pagedown” button, and then confirm by “enter”.



**Timer 2, NLF=OFF**

Press”menu” button again from Time1, window will switch to Timer2 setup interface. Press “enter” button once, you can adjust the “Hour”(1-12hours) via “Pageup/Pagedown” button, and then confirm by”enter”.



**NOTE**

Timer1 hour setting controls the time the load is turned ON after entering night mode; Timer2 hour setting controls the time the load is turned OFF after Timer1 has finished. Once Timer2 is finished, the load will turn ON automatically untill dawn.(See below diagram)

**There are 2 modes of night light load control available:** Standard Controller Mode and Evening/Morning Mode. To program standard controller mode, set NLF=OFF.

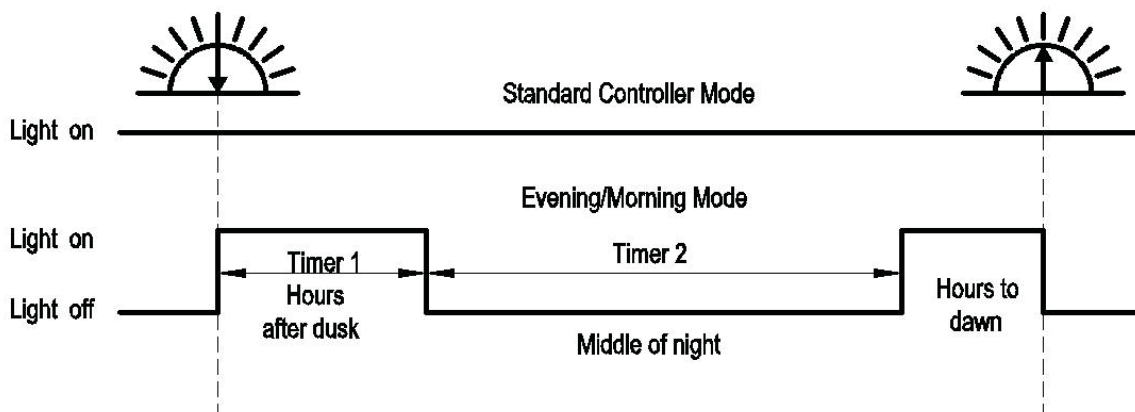

The MP-3739 recognizes days and night based on the solar array voltage. NLF will start when the PV(Voltage) < 10V for a period of time.

### Standard Timer1 & Timer2 setup, with NLF=OFF

If you set NLF=OFF, then you can program the standard load control functionality with Timer1 and Timer2. Press “menu” button 6 times from the default window, taking you to NLF setup interface. Press “enter” button once, choose NFL OFF via ‘Pageup/Pagedown’ button, and then confirm by “enter”.



Press “menu” button once from NLF window, Window will switch to Timer1 setup interface. Press “enter” button once, you can adjust ‘Hour’ via ‘Pageup/Pagedown’ button. After ‘Hour’ setup press ‘enter’ button for confirmation and switch to ‘Minute’ adjustment. You can use ‘Pageup/Pagedown’ button to adjust it. This can be confirmed by pressing ‘enter’ button. Through ‘Pageup/Pagedown’ button, choose ‘ON’ or ‘OFF’ or ‘ON/OFF’ and then confirm by ‘enter’ button.

Press ‘menu’ button again, window will switch to Timer2 setup interface. Similar operation for time and ON/OFF setup as mentioned above.

### NOTE for programming Timer1 & Timer2

Setting either Timer to ON sets the time when you want to turn the load on.

Setting either Timer to OFF sets the time when you want to turn the load off.

Setting either Timer to “ON/OFF” will disable the timer, and the load output will revert to manual load control.

## Functional Explanations

### 1. PWM Charge control

Depending on the actual battery level, various charging procedures, float charging, boost charging and equalization charging are automatically performed.

### 2. Deep discharging protection

If the battery falls below a specified charge level or battery voltage, the load output is disconnected and the discharge of the battery is prevented. The set points of the deep discharging protection are predefined and cannot be reset.

### 3. MPPT function

MP-3739 uses the latest MPPT technology at all times which gives the maximum available output of the solar module.

### 4. 5V USB output

Provide 5Vdc/500mA power supplier.

### 5. 2 timers, control the load output automatically.

## Installation

Danger of explosion from sparking! Danger of electric shock!

- ◆ Only install the controller near the battery on a suitable surface. This surface should be solid, stable, even, dry and nonflammable.
- ◆ The battery cable should be as short as possible (1-2m) and have a suitable cable diameter size for minimum loss.(Recommended cable for MP-3739 is 25 sq.mm and 2 m length)
- ◆ Do not install MP-3739 outdoors, the unit should be installed so that it is protected against humidity, dripping, rainwater as well as direct and indirect warming from sunlight.
- ◆ To ensure proper air circulation for cooling MP-3739, an area of 15cm on each side of the MP-3739 must be kept free.
- ◆ The LCD display should be protected against UV rays(e.g. sunlight). Long time exposure to UV rays can permanently discolor the LCD
- ◆ The solar charge controller may only be connected to the local loads and the battery by qualified personnel and in accordance with the applicable regulations.
- ◆ Follow the installation and operating instructions for all components of the PV system.
- ◆ Ensure that no cables are damaged.
- ◆ Ensure that polarity of Solar panel/battery/load is connected in proper way.
- ◆ Ensure all terminations are secure and clean.



## Warning

The controller may only be connected to the local loads and the battery by trained personnel and in accordance with the applicable standards and regulations.

Ensure that no cables are damaged.

At a voltage of 65V, particularly with regard to module open circuit voltage, the entire solar energy system must be installed with protection class II. Cover solar modules during installation

Use only insulated tools.

### 1. Mounting the solar charge controller

1.1 Do not mount the solar charge controller outdoors or in wet rooms

1.2 Do not subject the solar charge controller to direct sunshine or other source of heat.

1.3 Protect the solar charge controller from dirt and moisture.

1.4 Maintain a minimum clearance of 15cm below and around the device to ensure unhindered air circulation

1.5 Mount the solar controller as close as possible to the batteries (with a safety clearance of at least 35cm).

2. Fix the solar charge controller

2.1 Mark the position of controller fix holes on the walls;

2.2 Drill 4pcs Ø6mm holes and insert dowels.

2.3 Fix the controller to the wall with the cable openings facing downwards, using 4 oval head screws M4x35 (DIN 7996).

## Grounding

Grounding MP-3739 is not technically required when installing a stand alone solar system. However, if required, common grounding of the negative of the PV array, battery and load control output is OK for negative earth electrical systems (such as a caravan or motor-home).

**Caution: MP-3739 can ground the negative only.**

## Install the solar system and operating mode

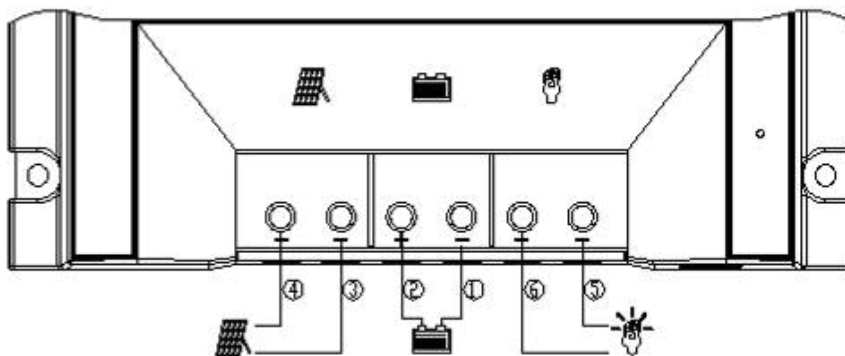

- Connect the wires in the sequence from 1 to 6 according the above diagram.  
Disconnect the wires in the REVERSE sequence from 6 to 1 according the above diagram.
- Use with 12V or 24V batteries, controller will detect voltage of battery automatically.
- Never exceed the nominal ratings for solar panel array: 360 Watts with 12 Volt battery/ 720 Watts with 24 Volt battery (see below technical data for reference).
- Suggested cable length, 10m solar panel connection cable/2m battery connection cable/5m load connection cable

## TECHNICAL INFORMATION

Max PV Array Size	180W-12V battery, 360W-24V battery
PV Array Voltage	12V or 24V nominal only
Max. Input Current	15ADC
Max. Input Open Circuit Voltage (OCV)	50VDC
Max. Load Current	15ADC
Charge Voltage(Bulk)	13.8V-14.8V/27.6V-29.6V
Charge Voltage(Float)	13.0V-14.2V/26.0V-28.4V
Deep Discharge Protection Voltage	11.0/22.0VDC $\pm$ 2%
Output Voltage	12/24VDC
Typical Idle Consumption	<50mADC
Operating temperature	-20°C/+50°C

### Charging Curve

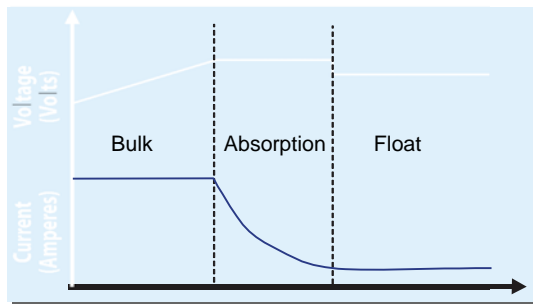

**Bulk:** This is the first stage where the battery is in a low charge state, where it receives the majority of its charge. During this stage the battery brought to about 85-95% capacity getting 100% of the available solar power.

**Absorption:** In this stage the controller charge at a constant voltage and the battery is allowed to absorb current at a constant voltage. The constant voltage regulation prevents overheating and battery gassing; this stage terminates when the battery current is below 3 Amp or after 3 hours entered in absorption mode.

**Float (Maintenance):** After the battery is fully charged, the controller reduces the battery voltage to a float charge, providing minimal current.

### Protection functions

- ◆ Overcharge protection
- ◆ Deep discharge protection
- ◆ Battery under-voltage protection
- ◆ Solar panel reverse current protection

The following faults will not destroy the controller. After correcting the fault, the device will continue to operate normally:

- ◆ Overcharge protection
- ◆ Deep discharge protection
- ◆ Reverse polarity protection of load, panel and battery
- ◆ Automatic electronic fuse
- ◆ Short circuit protection of load and panel
- ◆ Over voltage protection for solar panel input and battery voltage
- ◆ Open circuit protection without battery
- ◆ Reverse current protection at night
- ◆ Overload protection

## **Maintenance**

The controller is maintenance-free. We strongly suggest that all components of the PV system are checked at least annually,

- ◆ Ensure adequate ventilation of the cooling element or body of the controller.
- ◆ Check any cable strain reliefs
- ◆ Check that all cable connections are secure
- ◆ Tighten screws if necessary
- ◆ Check and remove any terminal corrosion

## **Error Messages**

Caution! Please do not open the controller or attempt to replace components when troubleshooting. Improper maintenance can be hazardous to the user and the system.

If the controller detects errors or unauthorized operating states, it shows error codes on the display. Error codes can generally be differentiated, whether there is a temporary malfunction, e.g. regulator overload or a more serious system error that can be remedied by appropriate external measures.

Since not all errors can be simultaneously displayed, the error with the highest error number (priority) is displayed. If several errors are present, the second error code is displayed after remedying the more significant error.

The following meaning is assigned to the different error codes:

1.  Meaning: Battery polarity reverse warning

Remedy: Reconnect cable of battery in proper way.

2.  Meaning: Battery is wrong.

Remedy: Check battery voltage it might be too low or too high. Recharge battery manually if necessary. If battery can't be recharged, it might be deeply discharged. Replace battery if necessary.

3.  Meaning: Module current too high.

Remedy: Reduce the load current or module power.

4.  Meaning: Over current at the load output.

Remedy: Reduce load current.

If reducing load current does not work, one of the two situations occurred:

- 1) No load connected, press "Enter" button, LCD showing E4.
- 2) If the load is over 50W, press "Enter" button, load current showing 0.00A.

Reset: Remove all connections in Reverse sequence from 6 to 1(as advised on page 6), then follow the reset procedure:

- i. While holding down the "Menu" button, connect the Battery terminals
- ii. Release the "Menu" button, this will prompt the LCD to show "FFFF"
- iii. First connect the PV then the Load terminals

**NOTE:** Always connect the Negative first, then the Positive for all connections

5.



Meaning: Over voltage on the battery. Which means the battery is abnormally over charged.

Remedy: replace the battery.

Generally with an aged battery system, it gets higher voltage when charging due to the depreciation of the capacity. Replace the battery system to see if the problem still exists.



Electrical products should not be disposed with household waste

Please recycle where available

Check with your local authority or retailer for recycling advice

Specifications are subject to change without prior notice

Distributed by:  
Electus Distribution Pty Ltd  
320 Victoria Rd  
Rydalmere NSW 2116 Australia  
Ph: 1300 738 555  
Fax: 1300 738 500  
[www.electusdistribution.com.au](http://www.electusdistribution.com.au)