

**POWERTECH PLUS**



**POWERTECH PLUS**

**9STEP**

**SWITCH MODE  
BATTERY CHARGER**









For Lead-acid rechargeable batteries  
50-500Ah (12V), 25-250Ah (24V)  
& Lead-calcium rechargeable batteries  
25-100Ah (12V)



**MB-3608**

**User's Manual And  
Guide To  
Professional Battery Charger**

Distributed by:  
Electus Distribution Pty Ltd  
320 Victoria Road  
Rydalmere NSW 2116 Australia  
Tel: 1300 738 555  
Fax: 1300 738 500  
[www.electusdistribution.com.au](http://www.electusdistribution.com.au)

For Your Safety.....	2
Product Feature.....	2
Product Safety Feature.....	2
Contents.....	2
Safety Information.....	2-3
Locate Charger.....	3
Battery Type & Settings.....	3
Operation.....	4
Charging.....	4
Equipment Description.....	4
Indication.....	4-5
Component Description.....	6
Select Charging Mode.....	6
Reset/Deleting Settings.....	6
Identification of Overlap Voltage.....	6
Charging Status Indication.....	7
Switching Over between different Modes.....	7
MODE 1  (28.8V/12.5A & 29.4V/12.5A).....	7
MODE 2  (32V/1.5A BOOST).....	8
MODE 3  (14.4V/25A & 14.7V/25A).....	8
MODE 4  (14.4V/5A NIGHT).....	8
MODE 5  (16V/1.5A BOOST).....	9
MODE 6  (13.6V/5A MANUAL).....	9
MODE 7  (13.6V/5A SUPPLY).....	9
MODE 8  (16V/5A Ca).....	10
Rescuing Drained Battery.....	10
Abnormality Protection.....	10
Overheating Protection.....	10
Temperature Compensation.....	10
Bulk Charging Time.....	10
Technical Data.....	11
Charging Phases.....	11-14
Diagnosis & Recovery.....	13
Bulk.....	13
Absorption.....	14
Analysis.....	14
Trickle Charge.....	14
Maintenance Charge.....	14

Boost.....	14
Manual Special Maintenance.....	14
Supply.....	14
Error Mode.....	14
Power Mode.....	14
Trouble Shooting.....	15
Maintenance and Cleaning.....	15
Storage Instructions.....	15
Mounting & Product Dimensions.....	16
Application.....	16
Equipment.....	16
Declaration of Compliance.....	16

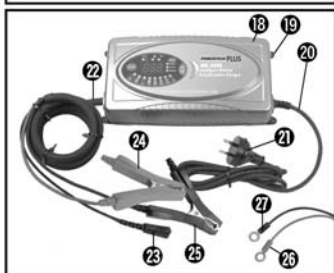
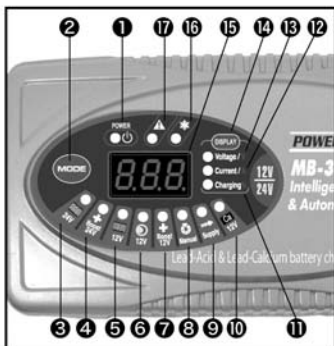

## For Your Safety

This manual contains important safety and operating instructions. Read this manual carefully before using the charger and keep the manual in a safe place for future reference.

## Product Feature

For Lead acid batteries 50-500Ah (12V), 25-250Ah (24V) & Lead-Calcium batteries 25-100Ah (12V) Congratulations on your purchase of the **Powertech MB-3608** 9-Step fully automatic switch mode battery charger and maintainer, designed for charging a variety of 12V and 24V lead-acid and 12V Lead-Calcium rechargeable batteries, widely used in boats, cars, trucks, agriculture and several other vehicles. The batteries may be of various types i.e. WET/Flooded (Liquid Electrolyte), GEL (Gelatin type Electrolyte, absorbed into the plates), AGM (Absorbed Glass Mat), MF, VRLA (Valve Regulated Lead Acid), Lead-Calcium batteries. Their capacity range from 50-500Ah (12V), 25-250Ah (24V); Lead-Calcium batteries 25-100Ah (12V). The **Powertech MB-3608** battery charger also charges batteries in cold conditions. Using state-of-the-art technology, the charger enables the recharging of the batteries to almost 100% of their original capacity. It recovers slightly sulfated batteries. It diagnoses and rescues drained battery. It provides trickle charge and maintenance charging which increases battery life and gives superb performance. The **Powertech MB-3608** battery charger provides ten output options to meet numerous requirements i.e. 28.8V, 29.4V, 14.4V, 14.7V, 16V/CALCIUM, 14.4/NIGHT, 16V/BOOST, 32V/BOOST, 13.6V/MANUAL and 13.6V/SUPPLY. It has 12 Stage charging strategy i.e. Pulse charge, 25.0A, 12.5A, 10.0A, 5.0A, 1.5A, 1.0A (max), Night mode charge, Boost charge (12V battery), Boost charge (24V battery), Manual Special Maintenance charge & Power Supply. The charger also features low back current drain and low ripple.

**Memory Function:** The charger has unique memory function. The charger returns to last selected mode automatically when power is switched on (*this feature is unavailable for SUPPLY and BOOST modes*). For repetitive charging process, this is a very useful feature. However different charging mode could be selected by pressing the "MODE" button.

**Night charge mode:** The **Powertech MB-3608** is provided with Night charge mode. This is silent mode in which charging is performed at reduced current. After remaining in this mode about 9 hours (max), charger returns to normal charge mode. This is important feature for boat and caravan users.

## Product Safety Feature

- Electronically safe against user errors. The charger will not damage vehicle electronics. It is totally safe for months-long connections and maintenance of irregularly or seasonally used batteries even while the charger is still connected to the vehicle. It provides optimal condition without damage. **No risk of over-charging!**
- Full protection against wrong connection and against short circuit ensures safe charging operation.
- Provided with Spark protection mechanism. This feature does not activate when the charger is in Supply mode. The charger will not begin operation upon connection to the battery unless charging mode has been selected. This embedded feature eliminates the possibility of a spark that often appears during connections.
- Fully controlled by internal MCU (Micro-Computer-Unit), which makes it faster, powerful, reliable and smarter. It detects the state of charge of the battery plugged into it and initiates charging.
- Splash proof (IP44).
- Double insulated

## Contents

- 1) **Powertech MB-3608** Charger
- 2) Quick contact 1.8m long battery leads with heavy duty clamps
- 3) 1.85m long Cable with temperature sensor
- 4) User Manual

## Safety Information

- **Powertech MB-3608** charger is designed for charging Lead acid rechargeable batteries 50-500Ah (12V), 25-250Ah (24V) and Lead-Calcium batteries 25-100Ah (12V). Do not use it for any other purposes. It may cause an explosion.
- ⚠ **WARNING! DO NOT ATTEMPT TO CHARGE A NON-RECHARGEABLE BATTERY (PRIMARY CELLS).**
- Before charging make sure the input power is as per rated specifications, otherwise the charging performance may be seriously affected.
- **Do not** use battery charger for charging dry-cell batteries. They may burst and cause injury to persons and damage to property.
- Never charge a frozen battery.
- Never charge a damaged battery.
- **Do not** use the charger with a damaged cable . It must be replaced by the manufacturer, its service agent or similarly qualified technician in order to ensure safety.
- **Do not** operate charger if it appears to be damaged or malfunctioning. Take it to qualified person for inspection and repair.
- **Do not** disassemble charger, incorrect reassembly may result in electric shock or fire. Locate charger as far away from battery as DC cable permit.
- Never place charger above battery being charged, gases from battery will corrode and damage charger.
- While charging always use safety glasses, gloves, protective clothing and keep your face away from the battery.
- Remove metal items such as rings, bracelets, necklaces, and watches when working with a lead-acid battery. A lead-acid battery can produce a short-circuit current high enough to melt such metallic objects, causing a severe burn.







- **Explosion hazard!** A battery being charged could emit explosive gasses. Avoid smoking or open sparks or flames in the vicinity of the battery. Explosive and flammable substances such as fuel or solvents should not be kept in the vicinity of the charger or the battery.
- Disconnect the supply before making or breaking connections to the battery.
- While connecting the charger to the battery, maintain right polarity connection and avoid short-circuiting.
- Connect the appropriate DC clip to the battery post which is not connected to the automobile chassis. (The battery terminal not connected to the chassis has to be connected first.)
- Connect the other DC connector to the chassis, away from the battery and fuel line.
- The connector to be fixed to the positive pole shall be coloured red and that to be connected to the negative pole shall be coloured black.
- Then connect the battery charger to the supply mains.
- Do not cover the charger while charging.
- Do not touch the battery clips together when charger is connected with mains.
- After charging, disconnect the battery charger from supply mains. Remove the chassis connection and the battery connection, respectively. This will reduce back drain current.
- Charging must be ceased immediately if battery is found to be too hot or leaks out liquid during charging.
- In case of malfunction or damage, immediately disconnect the charger from the mains.
- Do not use vehicle when charging permanently installed batteries.
- During charging the battery must be placed in a well ventilated area.
- **Danger of chemical burns!** Battery acid is highly corrosive. If your skin or eyes come into contact with acid, immediately rinse the affected part of the body with excessive water and seek medical advice.
- This appliance is not intended for use by persons (including children) with reduced physical, sensory or mental capabilities, or lack of experience and knowledge, unless they have been given supervision or instruction concerning use of the appliance by a person responsible for their safety.
- Children should be supervised to ensure that they do not play with the appliance.
- Ensure that charger switches to maintenance charge mode, before it is left unattended and connected for long time. If this stage does not arrive within 73 hours (max), the charger must be disconnected manually.





#### Locate Charger

- Locate the charger as far away from battery as the DC cord permits.
- While charging do not place charger directly above or below the battery. Gases or fluids from the battery will corrode and damage the charger.
- Never allow battery acid to drip on the charger when reading electrolyte specific gravity or filling battery.
- Charging should be carried out in a well-ventilated, weather protected facility.

#### Battery Type & Settings

The following recommendations should only be referred to as guidelines. For precise details, you must refer to battery manufacturer for instructions.

Symbol	Mode	Settings	Details
	1	28.8V/12.5A	This mode is normally suitable for 24V WET, MF and GEL batteries.
	1 (Cold Temperature)	29.4V/12.5A	This mode is recommended for several 24V AGM batteries. It is also suitable for charging batteries in sub-zero temperatures.
	2	32V/1.5A BOOST	This mode is mainly applied for recovering 24V batteries with capacity range from 25-250Ah in normal condition. To recover severely discharged batteries due to stratified acid, this mode is useful. High voltage (32V max) at 1.5A is applied for a maximum period of 2 hours. Battery must be fully charged. <b>Caution!</b> High voltage may cause some water loss. For optimal efficiency, battery must be disconnected. <b>NOT SUITABLE TO BOOST LEAD-CALCIUM BATTERY!</b>
	3	14.4V/25A	This mode is normally suitable for 12V WET, MF and GEL batteries.
	3 (Cold Temperature)	14.7V/25A	This mode is recommended for several 12V AGM batteries. It is also suitable for charging batteries in sub-zero temperatures.
	4	14.4V/5A NIGHT	This mode is suitable for 12V WET, MF and GEL batteries during night time. This is normal charge mode, in which charging is performed at reduced 5A current. In order to maintain almost silence, the cooling fan is disabled. 9 Hours after remaining in this mode, charger returns to normal mode. Embedded memory feature enables charger to return in Night charge mode even in event of power failure.



Symbol	Mode	Settings	Details
	5	16V/1.5A BOOST	This mode is mainly applied for recovering 12V batteries with capacity range from 50-500Ah in normal condition. To recover severely discharged batteries due to stratified acid, this mode is useful. High voltage (16V max) at 1.5A is applied for a maximum period of 4 hours. Battery must be fully charged. <b>Caution!</b> High voltage may cause some water loss. For optimal efficiency, battery must be disconnected. <b>NOT SUITABLE TO BOOST LEAD-CALCIUM BATTERY!</b>
	6	13.6V/5A MANUAL	This mode is suitable for manually maintenance of 12V batteries with a capacity range from 50-500 Ah. The charger delivers a constant voltage of 13.6V. This is maintenance mode for applications where maximum capacity from the battery is required such as Golf Carts, Floor Sweepers etc. This mode would not work, if battery is not connected with the charger.
	7	13.6V/5A SUPPLY	<b>Powertech MB-3608</b> battery charger is also used as a <b>power supply</b> , without attaching a battery in this mode. The charger delivers 13.6V/5A. Spark free function is inactivated. Reverse polarity protection still works.
	8	16V/5A Ca	This mode is suitable for 12V Lead-Calcium rechargeable batteries with a capacity range from 25-100Ah. <b>NOT RECOMMENDED TO CHARGE A NON-CALCIUM BATTERY!</b>

**CAUTION!** 24V battery may consist of more than one battery of lower voltage. Therefore apply correct charging mode.

## OPERATION



### Charging

- Charging of a permanently installed battery in a vehicle
  - Before connecting or disconnecting the battery leads, the power cord should be removed from the mains.
  - Check polarity of battery post. A positive (+) battery post usually has a larger diameter than a negative (-) post.
  - Identify the pole of battery which is connected to the chassis (earth). Normally the negative terminal is connected to the chassis.
  - Charging of negative earthed battery:
    - Make sure the black wire **25** (-) pole connection) has not contact with the fuel line or the battery.
    - Connect the red wire **24** (+) to the positive (+) pole of the battery and the black wire (-) to the vehicle chassis.
  - Charging of positive earthed battery:
    - Make sure the red wire **24** (+) pole connection) has no contact with the fuel line or the battery.
    - Connect the black wire **25** (-) to the negative (-) pole of the battery and the red wire **24** (+) to the vehicle chassis.
- Charging of a battery not connected to a vehicle
  - Before connecting or disconnecting the battery leads, the power cord should be removed from the mains.
  - Connect the red wire **24** (+) to the positive (+) pole of the battery and the black wire **25** (-) to the negative (-) pole.

In case of reverse polarity connection red LED  **17** indicates error mode. This function would not work in Supply Mode. Error indication light  **17** would be also shown if charge mode is initiated without connecting the battery to the battery leads.
- Charging with eyelet terminals (Permanent connection to the vehicle battery)
  - Before connecting or disconnecting the battery leads, the power cord should be removed from the mains.
  - Connect the red wire **26** (+) to the positive (+) pole of the battery and the black wire **27** (-) to the negative (-) pole.

## Equipment Description

### a) Indication:

INDICATION	SYMBOL	Description
<b>1</b>		Yellow LED on for "POWER" In case of open circuit or short circuit or reverse connection, LED lights up
<b>2</b>		"Mode" selection button

INDICATION	SYMBOL	Description
3		Red LED on for "Mode 1"(28.8V/12.5A) for 24V battery
3, 11 & 15		Red LED on for "Mode 1"(28.8V/12.5A), charging in progress. Digital display 15 shows charging percentage (%). Upon completion of full charge, digital display 15 shows "100"
3 & 16		Red LED on for "Mode 1" (29.4V/12.5A) for 24V battery (Sub-zero temperature charge mode) or 24V AGM battery (Normal Charge mode)
3, 11, 16 & 15		Red LED on for "Mode 1" (29.4V/12.5A), charging in progress. Digital display 15 shows charging percentage (%). Upon completion of full charge, digital display 15 shows "100"
4		Red LED on for "Mode 2" (32V/1.5A) "Boost" for 24V battery
4 & 15		Boost process in progress, digital display 15 flashes "BOS"
3, 11 & 15		Boost process finishes, returns to normal 24V, digital display 15 shows charging percentage (%)
5		Red LED on for "Mode 3"(14.4V/25A) for 12V battery
5, 11 & 15		Red LED on for "Mode 3"(14.4V/25A), charging in progress. Digital display 15 shows charging percentage (%). Upon completion of full charge, digital display 15 shows "100"
5 & 16		Red LED on for "Mode 3"(14.7V/25A) for 12V battery (Sub-zero temperature charge mode) or 12V AGM battery (Normal Charge mode)
5, 16, 11 & 15		Red LED on for "Mode 3" (14.7V/25A), charging in progress. Digital display 15 shows charging percentage (%). Upon completion of full charge, digital display 15 shows "100"
6		Red LED on for "Mode 4"(14.4V/5A) "Night Charge" for 12V battery
6, 11 & 15		Red LED on for "Mode 4"(14.4V/5A), charging in progress. Digital display 15 shows charging percentage (%). Upon completion of full charge, digital display 15 shows "100"
7		Red LED on for "Mode 5" (16V/1.5A) "Boost" for 12V battery
7 & 15		Boost process in progress, digital display 15 flashes "BOS"
5, 11 & 15		Boost process finishes, returns to normal 12V, digital display 15 shows charging percentage (%)
8		Red LED on for "Mode 6"( 13.6V/5.0A) "Manual Special Maintenance"
8, 11 & 15		Red LED on for "Mode 6"(13.6V/5.0A), charging in progress. Digital display 15 shows charging percentage (%). Upon completion of full charge, digital display 15 shows "100"
9		Red LED on for "Mode 7"( 13.6V/5.0A) "Power Supply"
9, 13 & 15		Red LED on for "Mode 7"(13.6V/5.0A), "Power Supply" in progress. Digital display 15 shows output Voltage.

INDICATION	SYMBOL	Description
10		Red LED on for "Mode 8"(16V/5A) for 12V Lead-Calcium battery
10, 11 & 15		Red LED on for "Mode 8"(16V/5A), charging in progress. Digital display 15 shows charging percentage (%). Upon completion of full charge, digital display 15 shows "100"
11		Red LED indicates "Charging Percentage"
12		Red LED indicates "Charging Current"
13		Red LED indicates "Charging Voltage"
14		"Display" selection button
15		Digital LED display to show Voltage, Current and Charging percentage (%)
16		Sub-zero temperature charging
17		Red LED indicates "Incorrect polarity/Fault"

#### b) Component Description

Indication	Description
18	Charger
19	Mounting Holes
20	1.8m Mains Rubber insulated cable 2x1.00 mm <sup>2</sup> , cable diameter 6.4mm <sup>2</sup>
21	Power plug
22	1.5m TPE Cord sheath, diameter 12mm <sup>2</sup>
23	1.85m Cable with Temperature Sensor
24	1.8m "+" Pole connection cable (red) with quick clamp (red)
25	1.8m "-" Pole connection cable (black) with quick clamp (black)
26	1.8m "+" Pole connection cable (red) with ring terminal
27	1.8m "-" Pole connection cable (black) with ring terminal

Note: 16 & 17 are not standard accessories for MB-3608. They could be specially ordered in place of 13 & 15

#### Select Charging Mode

Powertech MB-3608 battery charger has unique memory function. The charger returns to last selected mode automatically when power is switched on. For repetitive charging process, this is a handy feature. However to charge various batteries at different ambient temperature, charger is supplied with temperature sensor. In case of sub-zero temperature, higher voltage charge mode automatically gets selected. A specific charging mode could be also selected manually by pressing the mode 2 selection button until the LED for respective mode is lit. Within 0.5 second, the charger activates the selected mode.



#### Reset / Deleting Settings

In beginning of charging process after connection to the power supply, the charger automatically resets itself to "Power" basic settings and remains in 20 1 position unless further action is executed by the user. Yellow LED is lit.

#### Identification of Overlap Voltage



To treat a 14.6-21V±0.29V battery if it may be a fully charged 12V battery or deep-discharged 24V battery. Powertech MB-3608 charger smartly identifies correct nature of battery and provides appropriate course of action. Once the selection button mode 2 is pressed, charging LED 11 shall flash "on-off" cycle in 0.5 second. Within 1-2 minutes the embedded MCU would detect change in battery voltage. If battery voltage remains at original value or rises to a higher level, system would treat it as a 24V battery, if voltage falls, it is treated as a 12V battery. After correct identification, system would initiate action as described in "a", "b" or "c" under paragraph "Switching over between different Modes" until the battery is disconnected.







## Charging Status Indication

 15	 15 Reading	Voltage for 12V Battery "V"	Voltage for 24V Battery "V"	Charging Status	Charging Phases
FLASH	25	4.5~10.5	15~21	Below 25%	Diagnosis & Recovery
ON	25	10.5~12	21~24	25~50%	Bulk
ON	50	12~13.8	24~27.5	50~75%	Bulk
ON	75	13.8~14.4	27.6~28.8	75~100%	Absorption
ON	100			FULL	Maintenance

## Switching over between different Modes





### a) For 12V battery:

Once charger is connected with battery, MCU would run internal test and would ascertain if connected battery is 12 volt or 24 volt. It eliminates accidental selection of wrong battery by user. If battery is 12V, upon pressing the selection button  once, red LED of Mode 3\*  will illuminate. By repeatedly pressing the selection button  whole display of charging modes would be in following order-

 1 → "Mode 3\*"  (14.4V/25A) → "Mode 3\*"   (14.7/25A) (for AGM battery or automatic under sub-zero temperature) → "Mode 4\*"  (14.4V/5A) → "Mode 5\*"  (16V/1.5A) → "Mode 6\*"  (13.6V/5A) and repeats this cycle.



### b) For 24V battery:

Once charger is connected with battery, MCU would run internal test and ascertain if connected battery is 12 volt or 24 volt. If battery is 24V, upon pressing the selection button  once, red LED of Mode 1\*  will illuminate. By repeatedly pressing the selection button  whole display of charging modes would be in following order-

 1 → "Mode 1\*"  (28.8V/12.5A) → "Mode 1\*"   (29.4/12.5A) (for AGM battery or automatic under sub-zero temperature) → "Mode 2\*"  (32V/1.5A) and repeats this cycle.

### c) For 12V Supply & 12V Lead-Calcium battery:









Upon pressing the selection button  continuously for 3 seconds, display of various modes would be as under-



 1 → "Mode 7\*"  (13.6V/5A) → "Mode 8\*"  (16V/5A) and repeats this cycle.





\* = Automatic under sub-zero temperature

If selection button  is pressed, charging mode automatically switches to the next operation mode and begins functioning in the selected mode. However after a full charge, if battery is not disconnected from the charger, it remains in trickle charge mode, even if user switches it over to another mode. This protects battery from being damaged.







## MODE 1 (28.8V/12.5A and 29.4V/12.5A)

This mode is suitable for charging 24V batteries with capacity range from 25-250Ah in normal conditions. Connect the output terminals of the charger to the battery with right polarity. Connect the power cord to the power outlet to begin charging. Press the selection button  to select Mode 1 (LED 3). After executing this operation the corresponding red LED display  will light up. If no further process is activated, the electronic system will automatically start the charging with a current of 12.5A ±10%. During charging course, digital display  will show Charging status (%)  by default. However anytime during charging course, Battery Voltage, Charging Current could be also found out. By pressing  button, digital display  will show Battery Voltage, Charging Current and Charging status (%) in following sequence :  →  → 

Charging shall continue until battery is fully charged up to 28.8V±0.58V. At this stage, LED display  will still be in red but digital display  will show 100. Combination of Trickle current of <1.0A and Maintenance charge current of 1.5A is repeatedly applied to keep battery fully charged.









Under sub zero temperature, built-in temperature sensor enables charger to automatically apply higher voltage charge (29.4V/12.5A). In this phase LED  will light up together with LED  in red. Upon completion of charging, digital display  will show 100, however LED display  and LED  will still be in red. Battery is fully charged up to 29.4V±0.59V. Combination of Trickle current of <1.0A and Maintenance charge current of 1.5A is repeatedly applied to keep battery fully charged.















**To charge an AGM battery :** AGM batteries shall also require higher voltage charge even under normal temperature condition. To charge an AGM battery, press the selection button  2 two times to select Mode 1 (LED 3) together with LED 16. After executing this operation the corresponding red LED display  3 and  16 will light up simultaneously. If no further process is activated, the electronic system will automatically start the charging with a current of  $12.5A \pm 10\%$  at 29.4V. Upon completion of charging, digital display  15 would show . However LED display  3 and LED  16 will still be in red. Battery is fully charged up to  $29.4V \pm 0.59V$ . Combination of Trickle current of  $<1.0A$  and Maintenance charge current of 1.5A is repeatedly applied to keep battery fully charged.







#### MODE 2 (32V/1.5A)







To recover severely discharged 24V batteries due to stratified acid with capacity range from 25-250Ah, this mode is applied. A fully charged battery gives faster result. High voltage may cause some water loss. For optimal efficiency, battery must be disconnected.

Connect the output terminals of the charger to the battery with right polarity. Connect the power cord to the power outlet to begin charging. Press the selection button  2 to select Mode 2 (LED 4). After executing this operation the corresponding LED display  4 will illuminate in red. If no further process is activated, the electronic system will automatically begin boost function by delivering voltage  $32.0V \pm 0.64V$  with a output current of 1.5A  $\pm 20\%$ . Digital display  15 will flash and show "BOS" . Recovery attempt of a deep-discharged (16.0V) battery is terminated within 2 hours (max). BOOST process would stop as soon as battery voltage reaches to 27.2V. Now battery could accept normal charging and charger switches to mode 1  3 and follows charging process of mode 1  3. Digital display  15 will stop showing "BOS"  but show Charging status (%)  11 by default.

#### MODE 3 (14.4V/25A and 14.7V/25A)









This mode is suitable for charging 12V batteries with capacity range from 50-500Ah in normal conditions. Connect the output terminals of the charger to the battery with right polarity. Connect the power cord to the power outlet to begin charging. Press the selection button  2 to select Mode 3 (LED 4). After executing this operation the corresponding red LED display  4 will light up. If no further process is activated, the electronic system will automatically start the charging with a current of  $25A \pm 10\%$ . During charging course, digital display  15 will indicate Charging status (%)  11 by default. However anytime during charging course, Battery Voltage, Charging Current could be also found out. By pressing  14 button, digital display  15 will show Battery Voltage, Charging Current and Charging status (%) in following sequence:  13  $\rightarrow$   12  $\rightarrow$   11. Charging shall continue until battery is fully charged up to  $14.4V \pm 0.29V$ . At this stage, LED display  4 will still be in red but digital display  15 will show . Combination of Trickle current of  $<1.0A$  and Maintenance charge current of 1.5A is repeatedly applied to keep battery fully charged.







Under sub zero temperature, built-in temperature sensor enables charger to automatically apply higher voltage charge (14.7/25A). In this phase LED  4 will light up together with LED  16 in red. Upon completion of charging, digital display  15 will show , however LED display  4 and LED  16 will still be in red. Battery is fully charged up to  $14.7V \pm 0.29V$ . Combination of Trickle current of  $<1.0A$  and Maintenance charge current of 1.5A is repeatedly applied to keep battery fully charged.

**To charge an AGM battery :** AGM batteries will also require higher voltage charge even under normal temperature condition. To charge an AGM battery, press the selection button  2 two times to select Mode 3 (LED 5) together with LED 16. After executing this operation the corresponding red LED display  5 and  16 will light up simultaneously. If no further process is activated, the electronic system will automatically start the charging with a current of  $25A \pm 10\%$  at 14.7V. Upon completion of charging, digital display  15 will show . However LED display  5 and LED  16 will still be in red. Battery is fully charged up to  $14.7V \pm 0.29V$ . Combination of Trickle current of  $<1.0A$  and Maintenance charge current of 1.5A is repeatedly applied to keep battery fully charged.

#### MODE 4 (14.4V/5A)









This mode is suitable for 12V WET, MF and GEL batteries during night time. Embedded Memory feature enables charger to return in NIGHT charge mode even in event of power failure.

Connect the output terminals of the charger to the battery with right polarity. Connect the power cord to the power outlet to begin charging. Press the selection button  2 to select Mode 4 (LED 6). After executing this operation the corresponding red LED display  6 will light up. After a short interval, if no further process is activated, the electronic system will automatically start the charging with a current of  $5A \pm 10\%$ . This is silent charge process in which the cooling fan is disabled. During charging course, digital display  15 will show Charging status (%)  11 by default. However anytime during charging course, Battery Voltage, Charging Current could be also found out. By pressing  14 button, digital display  15 will show Battery Voltage, Charging Current and Charging status (%) in following sequence:  13  $\rightarrow$   12  $\rightarrow$   11.

Charging shall continue until battery is fully charged up to  $14.4V \pm 0.29V$ . At this stage, LED display  6 will still be in red but digital display  15 will show **100**. Combination of Trickle current of  $<1.0A$  and Maintenance charge current of  $1.5A$  is repeatedly applied to keep battery fully charged. Once Night mode  6 is activated and comes into action, within 9 hours if battery is not fully charged, it returns to Mode 3  5 which is indicated by red illumination of LED  5. Now charger applies normal charge as per MODE 3  5 ( $14.4V/25A$  and/or  $14.7V/25A$ ). The cooling fan is again activated.













#### MODE 5 5 (16V/1.5A)

To recover severely discharged 12V batteries due to stratified acid with capacity range from 50-500Ah, this mode is applied. A fully charged battery gives faster result. High voltage may cause some water loss. For optimal efficiency, battery must be disconnected.













Connect the output terminals of the charger to the battery with right polarity. Connect the power cord to the power outlet to begin charging. Press the selection button  2 to select Mode 5 (LED 7). After executing this operation the corresponding LED display  7 will illuminate in red. If no further process is activated, the electronic system will automatically begin boost function by delivering voltage  $16.0V \pm 0.32V$  with an output current of  $1.5A \pm 20\%$ . Digital display  15 will flash and show "BOS"  15. Recovery attempt of a deep-discharged (4.5V) battery is terminated within 4 hours (max). BOOST process would stop as soon as battery voltage reaches to 13.6V. Now battery could accept normal charging and charger switches to mode 3  5 and follows charging process of mode 3  5. Digital display  15 will stop showing "BOS"  15 but show Charging status (%)  11 by default.

#### MODE 6 6 (13.6V/5A)

**Manual Special Maintenance of 12V lead acid rechargeable batteries:** This mode is suitable for maintenance of 12V batteries with a capacity range from 50-500Ah. The charger delivers a constant voltage of 13.6V. This is special maintenance mode for applications where maximum capacity from the battery is required such as Golf Carts, Floor Sweepers etc. This mode will not work if battery is not connected with the charger.















Connect the output terminals of the charger to the battery with right polarity. Connect the power cord to the power outlet to begin charging. Press the selection button  2 to select Mode 6 (LED 8). After executing this operation the corresponding LED display  8 will light up. If no further process is activated, the electronic system will automatically start the special maintenance charging at constant voltage  $13.6V \pm 0.27V$  with an output current of  $5.0A \pm 10\%$ . During charging course, digital display  15 will show Charging status (%)  11 by default. However anytime during charging course, Battery Voltage, Charging Current could be also found out. By pressing  14 button, digital display  15 will show Battery Voltage, Charging Current and Charging status (%) in following sequence:  13  $\rightarrow$   12  $\rightarrow$   11. Upon completion of special maintenance, digital display  15 will show **100**. LED display  8 will be still in red. The charger has overload protection feature in this mode. If battery voltage falls below 4.5V and current to around 6A (max), the charger returns to  1 mode.



#### MODE 7 7 (13.6V/5A)

Powertech MB-3608 battery charger is also used as a power supply, without attaching a battery in this mode. The charger delivers 13.6V/5A. In this mode Spark free function is inactivated. However reverse polarity protection still works. Connect the output terminals of the charger to the target with right polarity. Connect the power cord to the power outlet to begin charging. Press the selection button  2 continuously for 3 seconds to select Mode 7 (LED 9). After executing this operation the corresponding LEDs display  9 and  10 will flash in sequence in red. Press the selection button  2 once. Now device enters into SUPPLY mode, the display LED  9 will illuminate in red and display LED  10 will switch off. After a short interval, if no further process is activated, the electronic system will automatically begin as a "Power Supply" with output voltage of  $13.6V \pm 0.27V$  and output current of  $5.0A \pm 10\%$ . Digital display  15 will show voltage  13 by default. However anytime during power supply phase, output Current could be also found out. By pressing  14 button, digital display  15 will show output Voltage and Current in following sequence:  13  $\rightarrow$   12. If output voltage drops to 12.0V or below, charger shall cut off output power and switches to  1.

This mode is suitable for charging 12V Lead-Calcium batteries with capacity range from 25-250Ah in normal conditions.

**WARNING!** This mode is recommended to use only to charge Lead-Calcium batteries. **DO NOT ATTEMPT TO CHARGE A NON LEAD-CALCIUM BATTERY UNDER THIS MODE!**



Connect the output terminals of the charger to the battery with right polarity. Connect the power cord to the power outlet to begin charging. Press the selection button  continuously for 3 seconds to select Mode 8 (LED 10). After executing this operation the corresponding LEDs display  and  will flash in sequence in red. Press the selection button  two times. Now device enters into **Calcium charge** mode, the display LED  will illuminate in red and display LED  would switch off. After a short interval, if no further process is activated, the electronic system will automatically begin Lead-Calcium battery charge mode, the  with charging voltage of 16.0V±0.32V and charging current of 5.0A±10%. Digital display  will show charging percentage  by default. Anytime during charging course, by pressing  button, digital display  will indicate Battery Voltage, Charging Current and Charging status (%) in following sequence:  →  → . When battery is charged up to 14.7V, charging current is stopped for about 30 minutes and battery is again charged with constant voltage at 16.0V±0.32V and constant current at 1.5A±20% until voltage reaches to 16V.

Upon completion of charging, digital display  will show . LED display  will still be in red. Battery is fully charged up to 16.0V±0.32V. Combination of Trickle current of <1.0A and Maintenance charge current of 1.5A is repeatedly given to keep battery fully charged.

### Rescuing Drained Battery

When charger is connected to a battery, before the start of charging process, the charger automatically detects the voltage of the battery. If voltage is below 4.5V (for 12V battery) and 16V (for 24V battery) the **Powertech MB-3608** charger will not start due to its internal safety circuit. It initiates pulse charging mode if the voltage is in the range of 4.5V±0.10V to 10.5V±0.20V (for 12V battery) and 16V±0.32V to 21V±0.42V (for 24V battery). Once voltage of battery rises to 10.5V±0.25V (for 12V battery) or 21V±0.42V (for 24V battery) charger changes over to previously selected charging mode. Now the battery can be charged faster and safely. Most drained batteries can be charged and used again using this procedure.

### Abnormality Protection

In case of short-circuit, open circuit, reversed polarity connection or battery voltage below 4.5V±0.10V (for 12V battery) or 16V±0.32V (for 24V battery), the charger will turn-off the electronic system and will immediately reset the system back to basic  position to avoid damage to battery and charger. Additionally, upon reverse connection,  LED will illuminate to indicate error.

### Overheating Protection

**Powertech MB-3608** charger is protected by NTC control. During the charging process, if the charger becomes too hot, the power output is automatically reduced to protect itself from damage. The charger continues to work trickle charge. Charger increases power automatically when the ambient temperature drops.

### Temperature Compensation

**Powertech MB-3608** charger is supplied with temperature sensor cable which monitors the temperature of the battery. Any increase of temperature from 25°C is managed by a reduced charging voltage, and vice-versa. This ensures battery is fully charged, maintaining gassing threshold while protecting the battery from "boiling" due to over charging at high temperature or under charging of battery at low temperature.

### Bulk Charging Time

Battery Size (Ah)	For about 80% Charge (hours)		
	12V	24V	12V Calcium
25		5	13
50	5	10	25.5
75	7.5	15	38
100	10	20	50.5
150	15	30	
200	20	40	
250	25	50	
350	35		
500	50		

*Note: Above table is for reference only. Actual data may differ due to battery condition.*

**Technical Data**

MODEL	MB-3608
Input Voltage AC	220-240VAC, 50/60Hz
Input Operational Voltage AC	170-260VAC, 50/60Hz
Output Voltage	12V & 24V (Auto-Detect, Manual-Select)
Input Current	4A RMS max
Efficiency	>75%
Charging Voltage	28.8V±0.58V, 29.4V±0.58V, 14.4V±0.29V, 14.7V±0.29, 13.6V±0.27V, 16.0V±0.32V, 32V±0.64V
Charging Current	25.0A±10%, 12.5A±10%, 10.0A±10%, 5.0A±10%, 1.5A±20% and <1.0A
Back Current Drain*	5mA
Ripple**	Max 300mV, 0.15A
Ambient Temperature	-20°C to +50°C/-4°F to +122°F Reduced output power at higher temperature
Cooling	Fan
Type of Charger	Nine step, fully automatic, switch mode with maintenance charging
Type of Batteries	12V & 24V Lead-acid rechargeable batteries (WET, MF,AGM and GEL) 12V Lead-calcium rechargeable batteries
Battery Capacity	50-500Ah (for 12V) 25-250Ah (for 24V) 25-100Ah (for 12V Lead-calcium rechargeable batteries)
Dimensions (LxWxH)	260x135x70mm
Housing Protection	IP44 (Splash proof)
Weight	2.600kg
Noise Level	<50 dB (Night Mode, tested from a distance of 50cm)

\* = Back current drain is the amount of current drawn by the charger from battery, when the charger is connected to the battery, without power cord connected. **Powertech MB-3608** has extremely low back current drain which corresponds to 0.7 Ah per month (1mA/hr)

\*\* = Ripple refers to interference of current and voltage. A high current ripple heats up battery and reduces life of battery. Against a linear charger, which has a current ripple of up to 400%, **Powertech MB-3608** charger's current ripple is below 2% (0.15/12V or 0.3/24V battery voltage), which is much lower than the max 5% for a sealed acid battery. Equipments connected to the battery could be damaged by high voltage ripple.

**Charging Phases**

**Powertech MB-3608** charger performs 9-step fully automatic charging cycle.

MODE	SETTINGS	SYMBOL
1	28.8V/12.5A	
1 (Cold Temperature)*	29.4V/12.5A	
2	32V/1.5A BOOST	
3	14.4V/25A	
3 (Cold Temperature)*	14.7V/25A	
4	14.4V/5A NIGHT	
5	16V/1.5A BOOST	
6	13.6V/5A MANUAL	
7	13.6V/5A SUPPLY	
8	16V/5A Ca	

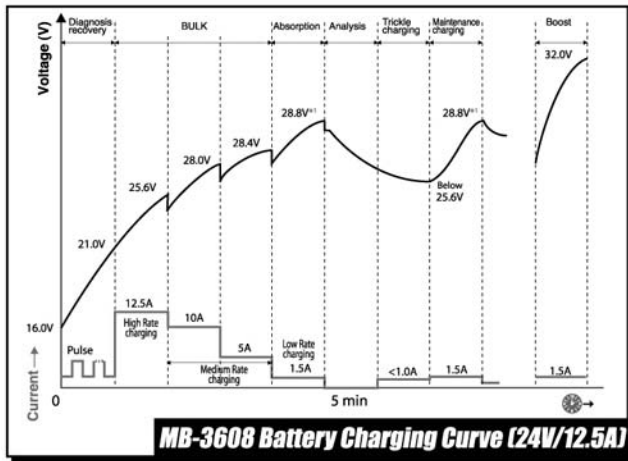

\* In case of cold weather charging, <sup>(1)</sup> voltage refers to 29.4V, instead of 28.8V

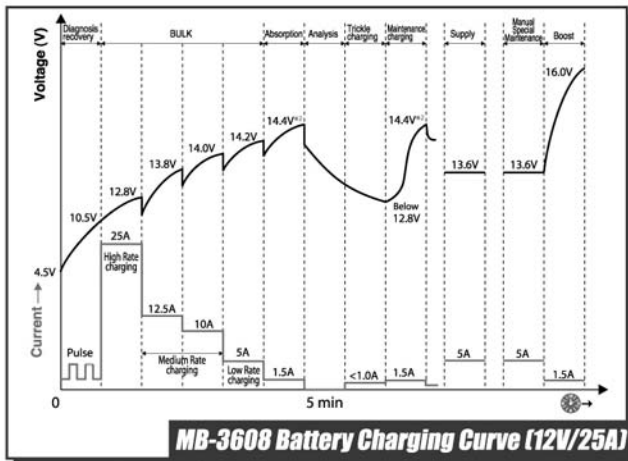

\* In case of cold weather charging, <sup>(1)</sup> voltage refers to 14.7V, instead of 14.4V

\* Also for AGM battery under normal temperature.

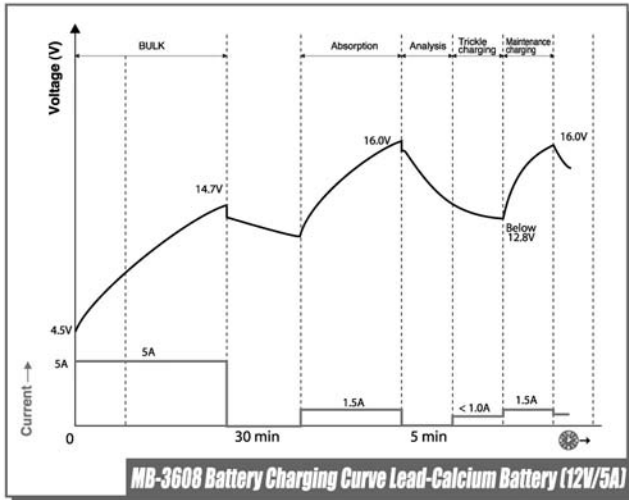

**1) Diagnosis & Recovery:** As soon charging instruction is given to the charger, the unique diagnostic function automatically checks status of battery (detects voltage). If a deeply discharged battery's voltage is over  $4.5V \pm 0.10V$  (for 12V battery) or  $16V \pm 0.32V$  (for 24V battery), charger begins pulse charging with 5.0A high current and 1.5A low current to recover it, which terminates when voltage reaches to  $10.5V \pm 0.25V$  (for 12V battery) or  $21V \pm 0.42V$  (for 24V battery). At this stage or if voltage of a battery is over  $10.5V \pm 0.25V$  (for 12V battery) or  $21V \pm 0.42V$  (for 24V battery) at the beginning of the process, the charger skips pulse charging and it switches over to pre-selected charging mode. If within 7 hours voltage of battery does not rises to  $10.5V \pm 0.25V$  (for 12V battery) or  $21V \pm 0.42V$  (for 24V battery), charging process is terminated and battery is treated as bad battery.

**2) Bulk :** 80% of energy is returned in this phase of charging. Here charger performs in multi-stages:

**For 24V battery**

- a) **High Rate Charging:** Charger delivers constant current of 12.5A until the voltage reaches to 25.6V.
- b) **Medium Rate Charging:** Charger delivers constant current of 10.0A until the voltage reaches to 28.0V. Finally charger delivers 5.0A current until voltage reaches to 28.4V at which point the charger switches to Absorption phase.







**For 12V battery**

- a) **High Rate Charging:** Charger delivers constant current of 25A until the voltage reaches to 12.8V.
- b) **Medium Rate Charging:** Charger delivers constant current of 12.5A until the voltage reaches to 13.8V, at this level constant current is 10.0A until voltage reaches to 14.0V. Finally charger delivers 5.0A current until voltage reaches to 14.2V at which point the charger switches to Absorption phase. Since current is not delivered at highest constant level, **Powertech MB-3608** charger will minimize the heating up of the battery, and hence will eliminate the build up of gases. This ensures more efficient and safer performance.

**For 12V Lead-Calcium battery**

- a) Charger delivers constant current of 5A until the voltage reaches to 14.7V.

**3) Absorption:** Use of a constant high current for extended periods of time risks gassing the battery. Therefore a constant low charging current is applied at 1.5A to raise voltage from 28.4V to 28.8V (for 24V battery), 14.2V to 14.4V (for 12V battery) and 16.0V (for 12V Lead-Calcium battery). In this phase complete charging up to almost 100% is achieved. Charger switches to trickle charge phase after sensing that the battery is truly fully charged.

**4) Analysis:** After absorption phase, charger analyses condition of battery for 5 minutes. If voltage is still less than 12.3V (for 12V battery) and 24.6V for (24V battery) it indicates battery is not retaining" charge" and there is fault with the battery. Selected mode  or  or  or  would give warning indication by flashing of "FAL"  on digital display .

**5) Trickle Charge:** Battery is fully charged and ready to use. The battery will signal to the charger and will only take enough current to sustain small loads such as alarms etc or current leaks in the vehicle wiring circuit. Very low current of less than 1.0A is applied to the battery. When voltage drops below 25.6V (for 24V battery) or 12.8V (for 12V battery), monitoring circuit senses that battery needs more current to maintain its charge than available in trickle charge phase. The charger switches to maintenance Charge phase.

**Standby feature :** When battery remains connected with vehicle's wiring system, during the trickle mode, circuits continuously monitor the current drawn by the battery.

**6) Maintenance Charge :** As charger continuously monitors the terminal voltage in order to determine if a maintenance charging should be initiated. If the battery is loaded and/or terminal voltage falls below 25.6V (for 24V battery) or 12.8V (for 12V battery), the charger starts maintenance charging pulse at constant 1.5A until voltage reaches to 28.8V (for 24V battery), 14.4V (for 12V battery) or 16.0V (for 12V Lead-Calcium battery). Now maintenance charging is discontinued. Cycle of trickle charging and maintenance charging is repeated indefinitely to keep battery in good condition when it is not in use and enables charger to be left connected indefinitely.

**NOTE:** If the charger is left connected indefinitely, check water levels every four weeks or as recommended by battery manufacturer to ensure battery remains at proper level.

**7) Boost:** To recover severely discharged batteries **Boost** mode is a useful feature. In this mode, lead sulfate crystals are broken down within the battery cells and become active electrolyte again, which helps extend the battery life. It is recommended to use Boost mode periodically for optimal performance of the battery.

**For 24V battery**

High voltage (32V max) at 1.5A is applied for a maximum period of 2 hours. Upon completion of Boost stage it would switch over to normal charging Mode 1  (LED 3) 28.8V/12.5A.

**For 12V battery**

High voltage (16V max) at 1.5A is applied for a maximum period of 4 hours. Upon completion of Boost stage it would switch over to normal charging Mode 3  (LED 5) 14.4V/25A.

**8) Manual Special Maintenance 13.6V:** Powertech MB-3608 charger provides a constant voltage at 13.6V and current up to 5.0A. This is suitable for maintenance of 12V battery where maximum capacity from the battery is required such as Golf Carts, Floor Sweepers etc using Float charge approach at 100% of charge. Charger features electronic overload protection, which activates if battery voltage falls below 4.5V and current to around 6A (max). In this situation charger returns to  mode.

**9) Supply:** Powertech MB-3608 battery charger is also used as a power supply with maximum capacity of 13.6V/5A. In this mode spark free function is inactivated. However reverse polarity protection function still works. If output voltage drops to 12.0V or below, charger shall cut off output power and switches to  mode.

**Error Mode** 

The charger goes to Error mode  in following situation-

a) The battery is connected with reverse polarity poles

**Power Mode** 

The charger goes to Power mode  in following situations-

a) Charger's terminals are short circuited or open circuited when charging is initiated

b) Battery capacity too large

c) Attempt to charge a defective battery

d) Charging is initiated without any battery connected to the battery leads

e) Attempt to charge a battery whose voltage is below 4.5V±0.10V (for 12V & 24V batteries).





f) During Supply mode if output voltage drops to 12.0V or below.

g) During Manual Special Maintenance if battery voltage falls below 4.5V and current to around 6A (max).

h) The charger is in recovery mode for over 7 hours.

i) The charger is in bulk and absorption mode for over 41 hours.

## Trouble Shooting

Problem	Indication	Possible Cause	Solution
Charger does not work	Indicator lights are not on	No AC power	a) Check AC connections and make sure mains is switched on
Charger has no DC output	 or 	a) Battery is connected with reverse polarity poles b) Output is short circuited c) Poor contact from charger to battery	a) Check DC connection between charger and battery and make sure they are not short circuited b) Check if clamps or ring connectors are connected to the correct polarity c) Check if connectors are not greasy or corroded and making a clean connection and there are no loose or damaged connection
No charging current		a) Battery may be defective / excessive current draw b) Battery may be severely sulfated	a) Check battery condition b) If battery can not be de-sulfated, it must be replaced
Abnormal Display	"FAL" flashing on 	Battery is not retaining charge a) After analysis if voltage is less than 12.3V (for 12V battery) and 24.6 (for 24V battery) b) During pulse charging if voltage does not raise to 10.5V (for 12V battery) and 21V (for 24V battery) within 7 hours c) During boost mode if voltage does not raise to 13.6V within 4 hours (for 12V battery) and 27.2V within 2 hours (for 24V battery)	Replace the battery
Excessive charging time		a) Wrong battery type selected b) Battery capacity too large c) Charger is in recovery mode for over 7 hours d) Charger is in bulk and absorption mode for over 41 hours	a) Check battery type selection b) Battery can not be charged and must be replaced

## MAINTENANCE AND CLEANING

**Powertech MB-3608** charger does not need any specific maintenance. Only install, maintain or service this charger when it is disconnected from power socket.

- After use wipe dirt or oil from clip, cord, and the charger case with a dry cloth. **(Do not use any solvents)**
- Corrosion on the clips may be removed with a solution of water and baking soda.
- Coil charger cords to prevent damage.
- Examine cords periodically and replace damaged cords by an authorized qualified electrician.

**CAUTION: RISK OF ELECTRICAL SHOCK.** Do not attempt any servicing unless you are authorized and qualified to do so.

## STORAGE INSTRUCTIONS

- When not in use, store the charger in a dry place, preferably with its original packing, not subject to sub-zero temperature which could cause cord insulation to become stiff and possibly crack when uncoiled.
- Place these instructions with the charger during storage.



### Mounting & Product dimensions

The charger is easy to fix using four screws. Please refer to product drawing.

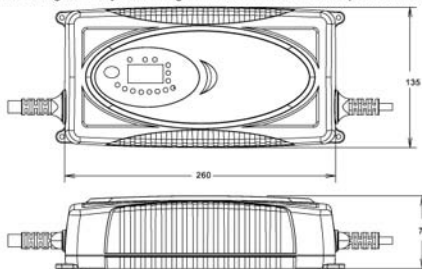

### Application

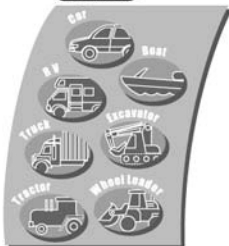

### Equipment

Powertech MB-3608 charger is supplied with colour coded lead with heavy duty clamps for bench charging.

### Connectors

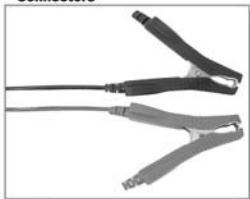

Quick Contact Battery Leads with Clamps



Temperature Sensor

### Declaration of Compliance

Tested and approved by Jiangsu TÜV Product Service Ltd. Guangzhou Branch and conforms to EN 60335-1/A13:2008, EN 62233:2008, EN 60335-2-29, EN 55014-1, EN 55014-2, EN 61000-3-2, EN 61000-3-3. Complied and tested to Australia/New Zealand electrical safety standards-AS/NZS CISPR 14.1:2003, AS/NZS60335.2.29 2004. **Electrical Safety Approval No.: SAA091121EA.**

Note: We reserve right to carry out technical modifications for improvement of MB-3608 charger without notice.

Environment friendly disposal

You can help protect the environment!

Please remember to respect the local regulations: hand in the non-working electrical equipments to an appropriate waste disposal centre. The packaging material is recyclable. Dispose of the packaging in an environmentally friendly manner and make it available for the recyclable material collection-service.

Distributed by:  
Electus Distribution Pty Ltd  
320 Victoria Road, Rydalmere NSW 2116 Australia  
Tel: 1300 738 555 Fax: 1300 738 500 [www.electusdistribution.com.au](http://www.electusdistribution.com.au)

