

POWERTECH PLUS

3STEP

SWITCH MODE BATTERY CHARGER



**For Lead Acid Rechargeable Batteries
1.2-20Ah (6V) & 1.2-20Ah (12V)**



MB-3603



**User's Manual And
Guide To
Professional Battery Charger**

For Your Safety	2
Product Feature	2
Product Safety Feature	3
Contents	3
Safety Information	3-4
Charger Location	5
Battery Type & Settings	5
Operation	5
Charging.....	5
Equipment Description.....	6
Indication.....	6
Component Description.....	6
Select Charging Mode.....	6
Reset/Deleting Settings.....	6
Switching Over between different Modes.....	6
MODE 1  (7.2V/750mA).....	7
MODE 2  (14.4V/750mA).....	7
Abnormality Protection.....	7
Overheating Protection.....	7
Bulk Charging Time	7
Technical Data	8
Charging Phases	8
Diagnosis & Bulk Charge.....	9
Trickle Charge.....	9
Maintenance Charge.....	9
Error Mode	10
Trouble Shooting	10
Maintenance	10
Mounting & Product Dimensions	11
Application	11
Equipment	11
Declaration of Compliance	11

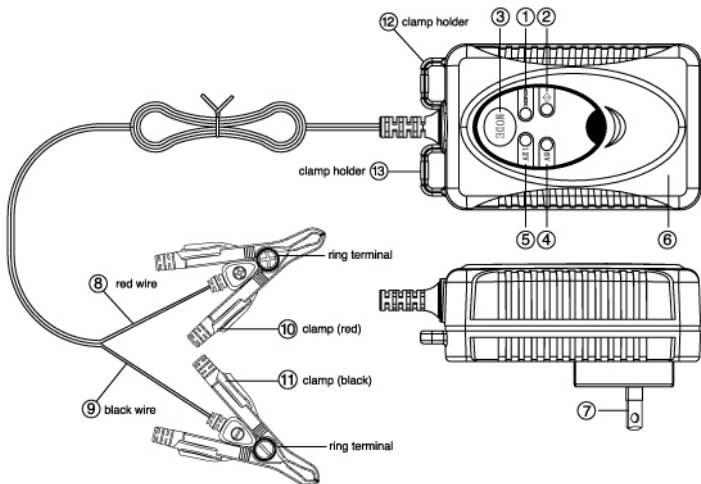

For Your Safety

This manual contains important safety and operating instructions. Read this manual carefully before using the charger for the first time and keep the manual in a safe place for future reference.

Product Feature

Congratulations on your purchase of the **Powertech MB-3603** 3-Step fully automatic switch mode battery charger and maintainer, designed for charging a variety of Lead-Acid rechargeable batteries, widely used in motorbikes and several other vehicles. The batteries may be of various types i.e. WET/Flooded (Liquid Electrolyte), GEL (Gelatin type Electrolyte, absorbed into the plates), AGM (Absorbed Glass Mat), MF, VRLA (Valve Regulated Lead Acid) batteries. Their capacity range from 6V/1.2Ah to 6V/20Ah and 12V/1.2Ah to 12V/20Ah. Using state-of-the art technology, the charger enables the recharging of the batteries to almost 100% of their original capacity. It recovers slightly sulphated batteries. It provides trickle charge and maintenance charging which increases battery life and gives superb performance. It is also ideal for maintaining batteries of non-regularly used vehicles of all types. It also features low back current drain and low ripple.

Product Safety Feature

- Electronically safe against user errors. The charger will not damage vehicle electronics. It is totally safe for months-long connections and maintenance of irregularly or seasonally used batteries even while the charger is still connected to the vehicle. It provides optimal condition without damage. **No risk of over-charging!**
- Full protection against wrong connection and against short circuit ensures safe charging operation.
- Provided with Spark protection mechanism. The charger will not begin operation upon connection to the battery unless charging mode has been selected. This embedded feature eliminates the possibility of a spark that often appears during connections.
- Fully controlled by internal MCU (Micro-Computer-Unit), which makes it faster, powerful, reliable and smarter. It detects the state of charge of the battery plugged into it and initiates charging.
- Dust and splash proof (IP60) approval. Approved for indoor use.
- Double insulated

Contents

- 1) Powertech MB-3603 Charger
- 2) Quick contact battery leads with clamps
- 3) Quick contact battery leads with eyelet terminals (Ø 6.3mm)
- 4) User Manual

Safety Information

- **Powertech MB-3603** charger is designed for charging 6V 1.2-20Ah and 12V 1.2-20Ah Lead-Acid rechargeable batteries. Do not use it to supply power to low voltage electrical system other than designated applications. Do not use it for any other purposes. It may cause an explosion. **WARNING! DO NOT ATTEMPT TO CHARGE A NON-RECHARGEABLE BATTERY (PRIMARY CELLS).**
- Before charging make sure the input power is as per rated specifications, otherwise the charging performance may be seriously affected.
- Do not use battery charger for charging dry-cell batteries. They may burst and cause injury to persons and damage to property.
- Never charge a frozen battery.
- Never charge a damaged battery.
- Do not operate charger if it appears to be damaged or malfunctioning. Take it to qualified person for inspection and repair.
- Do not disassemble charger, incorrect reassembly may result in electric shock or fire. Locate charger as far away from battery as DC cable permit.
- Never place charger above battery being charged, gases from battery will corrode and damage charger.



- While charging always use safety glasses, gloves, protective clothing and keep your face away from the battery.
- Remove metal items such as rings, bracelets, necklaces, and watches when working with a lead-acid battery. A lead-acid battery can produce a short-circuit current high enough to melt such metallic objects, causing a severe burn.
- **Explosion hazard!** A battery being charged could emit explosive gasses. Avoid smoking or open sparks or flames in the vicinity of the battery. Explosive and flammable substances such as fuel or solvents should not be kept in the vicinity of the charger or the battery.
- Disconnect the supply before making or breaking connections to the battery.
- While connecting the charger to the battery, maintain right polarity connection and avoid short-circuiting.
- Connect the appropriate DC clip to the battery post which is not connected to the automobile chassis. (The battery terminal not connected to the chassis has to be connected first.)
- Connect the other DC connector to the chassis, away from the battery and fuel line.
- The connector to be fixed to the positive pole shall be coloured red and that to be connected to the negative pole shall be coloured black.
- Then connect the battery charger to the supply mains.
- Do not cover the charger while charging.
- Do not touch the battery clips together when charger is connected with mains.
- After charging, disconnect the battery charger from supply mains. Remove the chassis connection and the battery connection, respectively. This will reduce back drain current.
- Charging must be ceased immediately if battery is found to be too hot or leaks out liquid during charging.
- In case of malfunction or damage, immediately disconnect the charger from the mains.
- Do not use vehicle when charging permanently installed batteries.
- During charging the battery must be placed in a well ventilated area.
- **Danger of chemical burns!** Battery acid is highly corrosive. If your skin or eyes come into contact with acid, immediately rinse the affected part of the body with excessive water and seek medical advice.
- This appliance is not intended for use by persons (including children) with reduced physical, sensory or mental capabilities, or lack of experience and knowledge, unless they have been given supervision or instruction concerning use of the appliance by a person responsible for their safety.
- Children should be supervised to ensure that they do not play with the appliance.
- Ensure that charger switches to maintenance charge mode, before it is left unattended and connected for long time.

Charger Location

- Locate the charger as far away from battery as the DC cord permits.
- While charging do not place charger directly above or below the battery. Gases or fluids from the battery will corrode and damage the charger.
- Never allow battery acid to drip on the charger when reading electrolyte specific gravity or filling battery.
- Charging should be carried out in a well-ventilated, weather protected facility.

Battery Type & Settings

The following recommendations should only be referred to as guidelines. For precise details, you must refer to battery manufacturer for instructions.

Symbol	Mode	Settings	Details
	1	7.2V/750mA	This mode is normally suitable for 6V (1.2Ah to 20Ah) WET/Flooded, GEL, AGM, MF, VRLA type Lead-Acid Rechargeable Batteries
	2	14.4V/750mA	This mode is normally suitable for 12V (1.2Ah to 20Ah) WET/Flooded, GEL, AGM, MF, VRLA type Lead-Acid Rechargeable Batteries







OPERATION

Charging

- 1) Charging of a permanently installed battery in a vehicle
 - a) Before connecting or disconnecting the battery leads, the power plug should be removed from the mains.
 - b) Check polarity of battery post. A positive ("+") battery post usually has a larger diameter than a negative ("-") post.
 - c) Identify the pole of battery which is connected to the chassis (earth). Normally the negative terminal is connected to the chassis.
 - d) Charging of negative earthed battery:
 - Make sure the black wire ⑨ ("-" pole connection) has not contact with the fuel line or the battery.
 - Connect the red wire ⑧ ("+") to the positive ("+") pole of the battery and the black wire ⑨ ("-") to the vehicle chassis.
 - e) Charging of positive earthed battery:
 - Make sure the red wire ⑧ ("+" pole connection) has no contact with the fuel line or the battery.
 - Connect the black wire ⑨ ("-") to the negative ("-") pole of the battery and the red wire ⑧ ("+") to the vehicle chassis.
- 2) Charging of a battery not connected to a vehicle
 - a) Before connecting or disconnecting the battery leads, the power plug should be removed from the mains.
 - b) Connect the red wire ⑧ ("+") to the positive ("+") pole of the battery and the black wire ⑨ ("-") to the negative ("-") pole. In case of reverse polarity connection red LED  ② indicate error
- 3) Charging with eyelet terminals
 - a) Before connecting or disconnecting the battery leads, the power plug should be removed from the mains.
 - b) Connect the red wire ⑧ ("+") to the positive ("+") pole of the battery and the black wire ⑨ ("-") to the negative ("-") pole.

Equipment Description

a) Indication:

INDICATION	SYMBOL	DESCRIPTION
①		Red LED for charging
①		Green LED for Full charging
①		Red LED flash, indicates "Fault"
②		Red LED displays "Incorrect polarity"
③		"Mode" selection button
④		Red LED on for "Mode 1" Charging 6V battery
⑤		Red LED on for "Mode 2" Charging 12V battery



b) Component Description

INDICATION	DESCRIPTION
⑥	Charger
⑫ & ⑬	Clamp Holders
⑦	Power plug
⑧	"+" Pole connection cable (red) with ring terminal
⑨	"-" Pole connection cable (black) with ring terminal
⑩	"+" Pole connection cable (red) with quick clamp (red)
⑪	"-" Pole connection cable (black) with quick clamp (black)

Select Charging Mode

A specific charging mode could also be selected manually by pressing the  ③ selection button until the light for correct voltage is lit. Within 0.5-2 second, the charger activates the selected mode.

Reset / Deleting Settings

In beginning of charging process after connection to the power supply, the charger automatically resets itself to  ④ &  ⑤ positions unless further action is executed by the user. Red LEDs are flashing.

Switching over between different Modes

By pressing the selection button  ③ displays the charging modes in the following order-
a) for 6V battery:







b) for 12V battery:







After a full charge, if battery is not disconnected from the charger, it remains in trickle charge mode. The default mode is OFF output.

MODE 1 7.2V/750mA

This mode is suitable for charging 6V batteries with capacity range from 1.2-20Ah in normal conditions. Connect the output terminals of the charger to the battery with right polarity. Put the power plug into the power outlet to begin charging. Press the selection button  ③ to select Mode 1  ④. After executing this operation the corresponding LED display  ④ will light up and  ① red LED will illuminate simultaneously. If no further process is activated, the electronic system will automatically start the charging with a current of $6.5V \sim 7.2V/750mA \pm 10\%$. When battery is fully charged  ① red LED would change into green. At this stage Trickle current in frequency of 750mA ON for 100mS, OFF for 900mS is given to the battery for maintenance.

MODE 2 14.4V / 750mA

This mode is suitable for charging 12V batteries with capacity range from 1.2-20Ah in normal conditions. Connect the output terminals of the charger to the battery with right polarity. Connect the power plug to the power outlet to begin charging. Press the selection button  ③ to select Mode 2  ⑤. After executing this operation the corresponding LED display  ⑤ will light up and  ① red LED will illuminate simultaneously. If no further process is activated, the electronic system will automatically start the charging with a current of $13.0V \sim 14.4V/750mA \pm 10\%$. When battery is fully charged  ① red LED would change into green. At this stage Trickle current in frequency of 750mA ON for 100mS, OFF for 900mS is given to the battery for maintenance.

Note: A battery left deep discharged for an extended period may result in permanent damage to one or more cells, which may heat up considerably during charging. Stop charging immediately if the battery casing temperature becomes very hot.

Abnormality Protection

In case of short-circuit, open circuit, reversed polarity connection or battery voltage below $3.75 \pm 0.25V$ (for 6V battery) or below $7.5 \pm 0.25V$ (for 12V battery), the charger will turn-off the electronic system and will immediately reset the system back to basic position to avoid damage to battery and charger.

Overheating Protection

Powertech MB-3603 charger is protected by NTC control. During the charging process, if the charger becomes too hot, the power output is automatically reduced to protect itself from damage. The charger continues to work trickle charge. Charger increases power automatically when the ambient temperature drops.

Bulk Charging Time

Time required for the **Powertech MB-3603** to complete a charge on a normally discharged battery is shown as under. Deep-discharged battery might take longer time to charge.

Battery Size (Ah)	For about 80% Charge (hours) Max	
	6V	12V
1.2	4	4
2	7	7
10	30	30
12	37	37
20	60	60

Note: Above table for reference only. Actual data may differ due to battery condition.

Technical Data



MODEL	MB-3603
Input Voltage AC	220-240VAC, 50/60Hz
Output Voltage DC	6V & 12V (Manual-Select)
Input Current	130mA RMS max
Efficiency	>70%
Charging Voltage	
Fast Charging Mode	3.75V±0.25V (for 6V Battery), 7.5V±0.25V (for 12V Battery)
Trickle Charging Mode	6.5V±0.25V (for 6V Battery), 13.0V±0.25V (for 12V Battery)
Maintenance Charging Mode	7.2V±0.25V (for 6V Battery), 14.4V±0.25V (for 12V Battery)
Charging Current	750mA±10%, 750mA ON 100mS OFF 900mS (average current 100mA)
Back Current Drain*	<35mA
Ripple**	Max 150mV, 0.2A
Ambient Temperature	-20°C to +50°C/-4°F to +122°F Reduced output power at higher temperature
Type of Charger	Three step, fully automatic, switch mode with maintenance charging
Type of Batteries	6V & 12V Lead-acid batteries (WET, MF, AGM and GEL)
Battery Capacity	1.2-20Ah (for 6V and 12V batteries)
Dimensions (LxWxH)	100x65x38mm
Housing Protection	IP60 (Dust and Splash proof) Indoor use
Weight	0.190kg
Noise Level	<50 dB (Tested from a distance of 50cm)

* = Back current drain is the amount of current drawn by the charger from battery, when the charger is connected to the battery, without the power cord connected. **Powertech MB-3603** has extremely low back current drain which corresponds to 0.7 Ah per month (1mA/hr)

** = Ripple refers to interference of current and voltage. A high current ripple heats up battery and reduces life of battery. Against a linear charger, **Powertech MB-3603** charger's ripple voltage is below 2.5% (0.15/6V or 0.3/12V battery voltage), which is much lower than the max 5% for a sealed acid battery. Equipments connected to the battery could be damaged by high voltage ripple.

Charging Phases

Powertech MB-3603 charger performs 3-step fully automatic charging cycle.

MODE	SETTINGS	SYMBOL
1	7.2V/750mA	
2	14.4V/750mA	

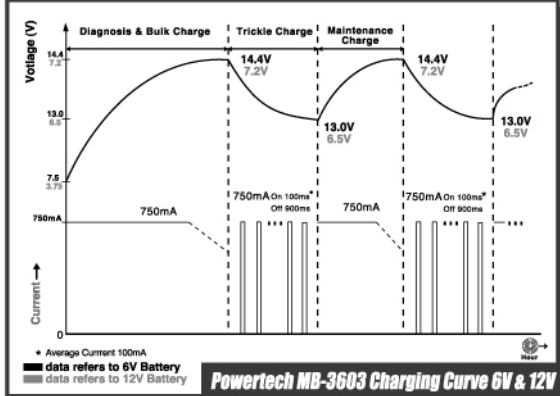

- 1) Diagnosis & Bulk Charge:** As soon charging instruction is given to the charger, the unique diagnostic function automatically checks status of battery (detects voltage). If a battery's voltage is over 3.75V (for 6V battery) or 7.5V (for 12V battery), charger begins fast charging mode by applying a constant current 750mA±75mA for both 6V or 12V battery, which terminates when voltage reaches 7.2V (for 6V battery) or 14.4V (for 12V battery).
 - 2) Trickle Charge:** Battery is fully charged and ready to use. Use of a constant high current for extended periods of time risks gassing the battery. The battery will signal to the charger and will only take enough current to sustain small loads such as alarms etc or current leaks in the vehicle wiring circuit. Low current in frequency of 750mA ON for 100mS, OFF for 900mS is given to the battery. Since current is not delivered constantly, **Powertech MB-3603** charger would minimize the heating up of the battery, and hence it will eliminate the build up of gases. This ensures more efficient and safer performance. When voltage drops below 6.5V±0.25V (for 6V battery) or 13.0V±0.25V (for 12V battery), monitoring circuit senses that battery needs more current to maintain its charge than available in trickle charge phase. The Charger switches to Maintenance Charge phase.
 - 3) Maintenance Charge:** As charger continuously monitors the terminal voltage in order to determine if a maintenance charging should be initiated. If the battery is loaded and/or terminal voltage falls below 6.5V±0.25V (for 6V battery) or 13.0V±0.25V (for 12V battery), the charger starts maintenance charging at constant 750mA until voltage reaches to 7.2V±0.25V (for 6V battery) or 14.4V±0.25V (for 12V battery). The maintenance charging is discontinued. Cycle of trickle charging and maintenance charging is repeated indefinitely to keep battery in good condition when it is not in use and enables charger to be left connected indefinitely.
- Standby feature :** When battery remains connected with vehicle's wiring system, during the trickle mode, circuits continuously monitor the current drawn by the battery.

Powertech MB-3603 is fully interactive charger which adjusts itself to changing current requirement to charge and maintain the battery.

Error Mode - RED LED flash ①

The charger goes to Error mode RED LED flashes  ① in following situations-

- a) After charging, battery's voltage is less than 3.75V+/-0.25V(for 6V battery)or 7.5V+/-0.25V(for 12V battery). This may be due to a defect in the battery itself such as a short-circuited cell or total sulfation.
- b) If wrong charging mode is selected such as 6V charging mode for a 12V battery or 12V charging mode for a 6V battery

Trouble Shooting

a) Error Mode - RED LED flash ①

- 1) Select correct 6V or 12V charging mode.
- 2) Remove the battery from the vehicle, reconnect the **Powertech MB-3603** and allow it to run a fresh test once again if  ① red LED flashes , it is the battery which is suspected and should be taken to a professional workshop for testing.

b) Maintaining a battery for extended periods:

At least once every two weeks, check that the connection between the charger and battery are secure. In case of batteries with filler caps on each cell, disconnect the battery from the charger, check the level of the electrolyte and if necessary, top up the cells with distilled water and then reconnect it.

c) Charger light does not turn on:

- 1) Remove the charger from the AC outlet and recheck the charger clamps are connected to the correct terminals and are making a clean connection.
- 2) Check to make sure AC outlet is supplying power.
- 3) A bad connection of the battery to ground.

d) Charger light is on but battery does not charge properly:

- 1) The battery may be defective or of oversize.
- 2) The battery has a excessive current draw, battery must be replaced.
- 3) Proper charging mode (6V or 12V) is not selected.

e) Incorrect polarity

 ② Red LED illuminates.

- 1) Disconnect the battery, check & connect the correct polarity of the battery.

Maintenance

Powertech MB-3603 charger does not need any specific maintenance. Only install, maintain or service this charger when it is disconnected from the mains. It may be cleaned with a dry cloth or soft tissue. Under any circumstances, do not use any solvents or other cleaning agents.

Mounting & Product dimensions

The charger is direct plug-in type. Please refer to product drawing.

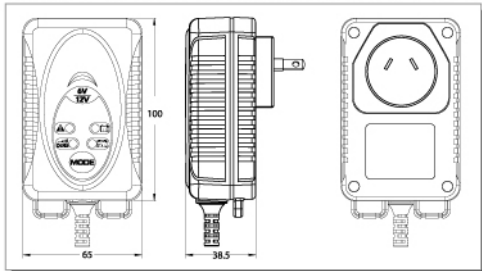

Equipment

Powertech MB-3603 charger is supplied with two kind of colour coded battery leads, one with clamps and one with eyelet terminals.

Application

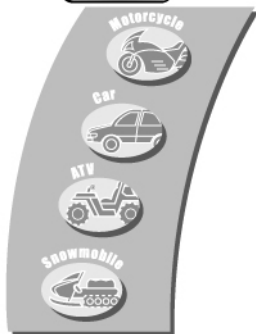

Declaration of Compliance

Tested and approved by Jiangsu TÜV Product Service Ltd. Guangzhou Branch and conforms to EN 60335-1, EN 60335-2-29, EN 55014-1, EN 55014-2, EN 61000-3-2, EN 61000-3-3, EN62233 Complied and tested to Australia/New Zealand electrical safety standards-AS/NZS CISPR 14.1:2003, AS/NZS60335.2.29 2004.
Safety Approval number Q090069

Note: We reserve right to carry out technical modifications for improvement of MB-3603 charger without notice.

Environment friendly disposal

You can help protect the environment!

Please remember to respect the local regulations: hand in the non-working electrical equipments to an appropriate waste disposal centre. The packaging material is recyclable. Dispose of the packaging in an environmentally friendly manner and make it available for the recyclable material collection-service.



Distributed by:

Electus Distribution Pty Ltd

320 Victoria Road, Rydalmere NSW 2116 Australia

Tel: 1300 738 555

Fax: 1300 738 500

www.electusdistribution.com.au