

# **NEXTECH**

**LA5047**



## **Smart WiFi PIR Motion Sensor**

### **Instruction Manual**

## **INTRODUCTION:**

LA5047 is a Wi-Fi based PIR sensor. You can check the device status, battery level, alarm record and even receive push notification via APP when it detects someone or animal moving within the detection range.

---

# **CONTENTS**

Product Features	<b>2</b>
Product Structure	<b>2</b>
Definition of LED Indicator	<b>3</b>
Button Instructions	<b>3</b>
Specifications	<b>3</b>
Installation	<b>4</b>
App Download	<b>5</b>
Registration	<b>5</b>
Add Devices	<b>6</b>
FCC Notice	<b>10</b>

## PRODUCT FEATURES:

- Digital PIR sensor with low power consumption and strong anti interference performance
- Standard 2.4G wireless Wi-Fi communication technology, two methods for Wi-Fi inclusion, EZ and AP
- 2 x CR123A batteries operated or USB powered
- Compliant with CE, FCC and Ro HS
- Elegant design and flexible installation
- Low battery alert and alarm push notification on APP
- Immediate report when vibration triggered

## PRODUCT STRUCTURE:

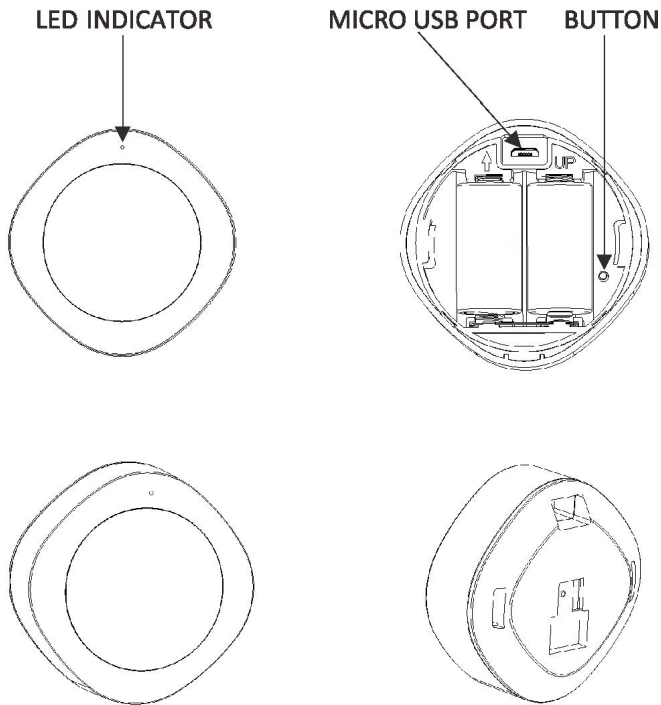

## DEFINITION OF LED INDICATOR:

AP Mode	LED indicator blink slow in blue
EZ Mode	LED indicator blink fast in blue

## BUTTON INSTRUCTION:

In the network	Press and hold the Button for 5s then release, resume to default setting, then it enters into EZ inclusion mode
Out of the network	Press and hold the Button for 5s then release to switch EZ/AP mode

### Note:

1. In the network: Device has been included into the network.
2. Out of the network: Device is in the default setting, never configured Wi-Fi
3. The duration of the configuration network is 2 minutes.

## SPECIFICATIONS:

Power Supply	6V:2*CR123A or SVUSB
Working Current	80mA
Standby Current	40uA
Battery Capacity	1300mAh
Detection Distance	10m
Detection Angle	120°
Sensitivity Level	8
Wireless Transmitting and Receiving Frequency	2.4 GHz-2.484GHz
Network Protocol Supported	IEEE802.11b/g/n
Encryption Type	WEP/TKIP/AES,WPS
Transmitting Power	802.11b: +17dBm@ 11Mbps 802.11g: +15dBm@ 54Mbps 802.11n: +13dBm@ MCS7
Working Temperature	-10 ~ +45°C
Storage Temperature	-20 ~ +85°C
Relative Humidity	8 ~ 80%RH

## INSTALLATION:

1. Power on (Battery or USB)

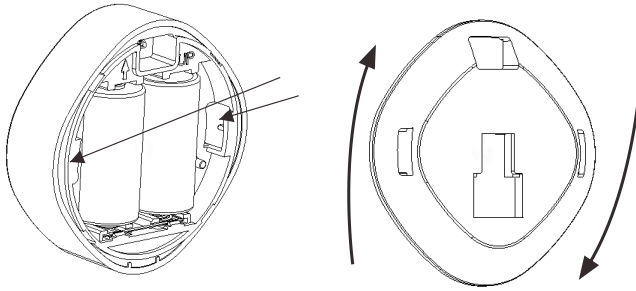

2. Install the sensor's holder in desired location with screws or 3M glue.

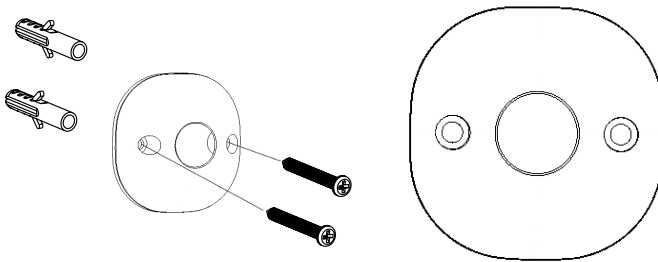

3. Insert the multi-sensor into its holder.

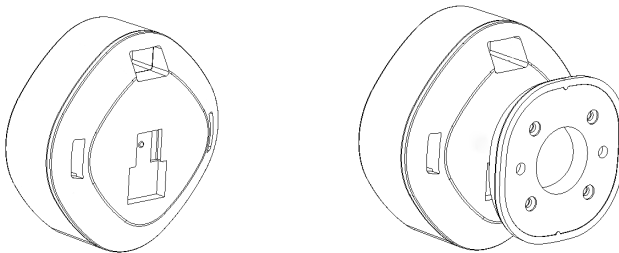

## APP DOWNLOAD:

Scan the QR codes below to download APP for Android or iOS System.



Android



iOS

## REGISTRATION:

Open the APP and type your mobile number or email address, and then confirm password to complete the registration.

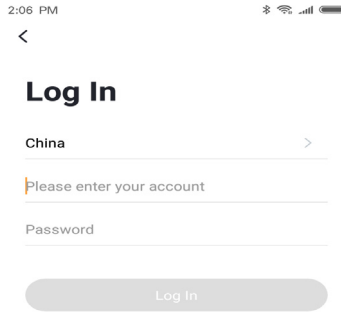
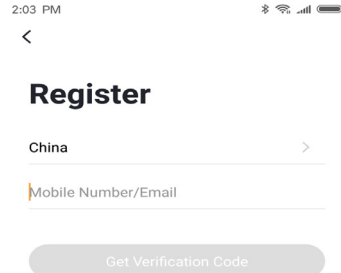
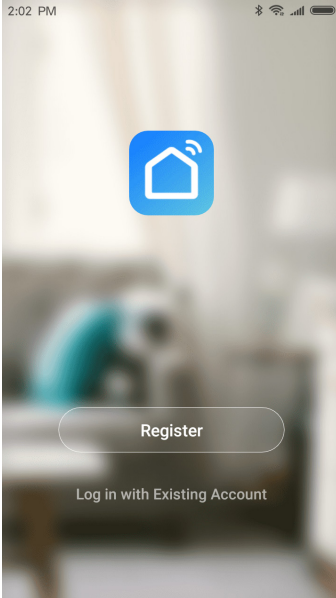

## ADD DEVICES:

1. Click "Add Device", Select the Device Type "Motion Sensor"

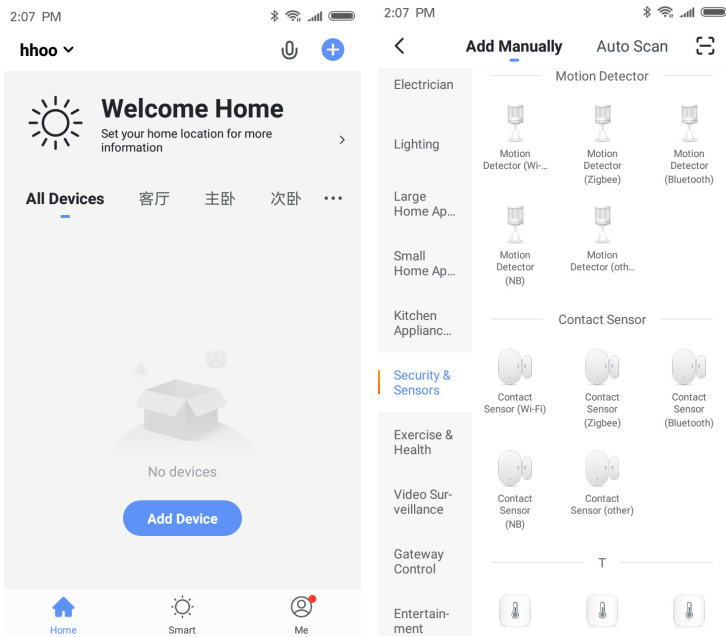

## ADD DEVICES:

### 2. EZ Mode

Power on, the blue LED indicator will blink fast, then enter the EZ mode. click the "Confirm indicator rapidly blink", and input the Wi-Fi password, click Confirm, it will show "connecting now". Once it is connected successfully, click done and return to the device main interface.

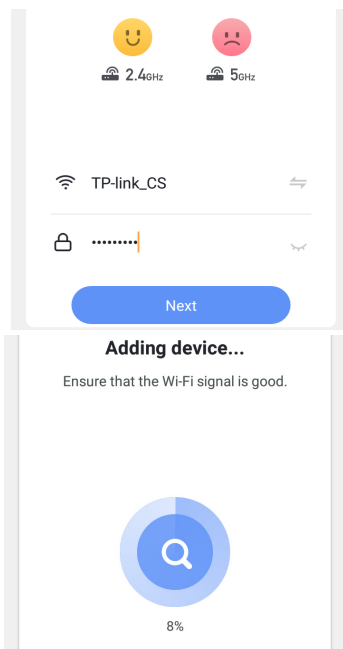
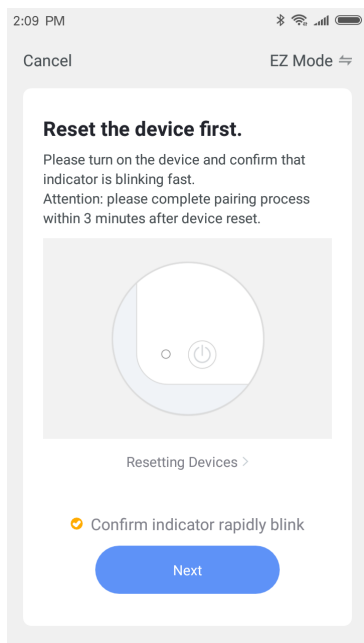



## ADD DEVICES:

### 3. AP Mode

When it into EZMode, Press and hold the button for 5s time, the blue LED indicator will blink slow, then enter the AP mode. Select AP Mode, click “Confirm indicator slowly blink”, and input Wi-Fi password, click “Confirm”.

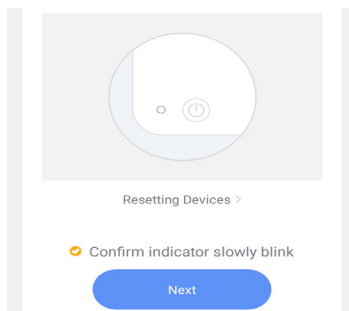
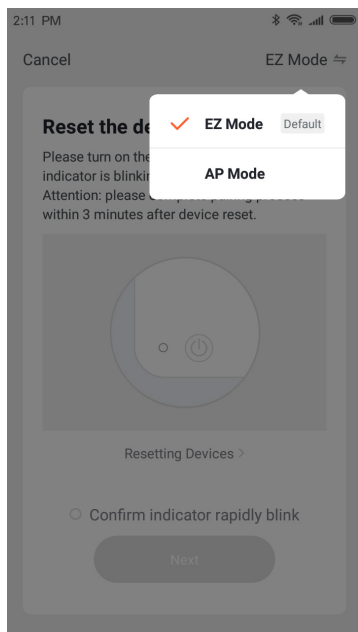

1. Please connect your phone to the hotspot shown below

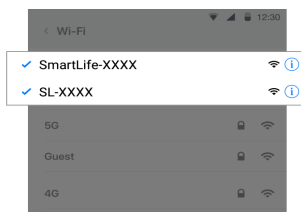

2. Return to this app and continue adding devices

## ADD DEVICES:

### AP Mode (continued)

Open the smartphone Wi-Fi list, select Smartlife\_XXXX, and get back when connected successfully, it will show "Connecting now" then. Once it is connected successfully, click done and return to the device main interface.

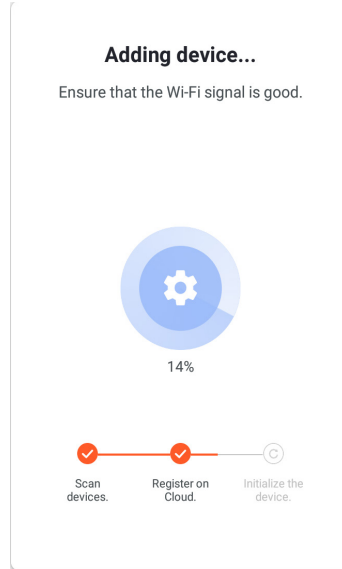
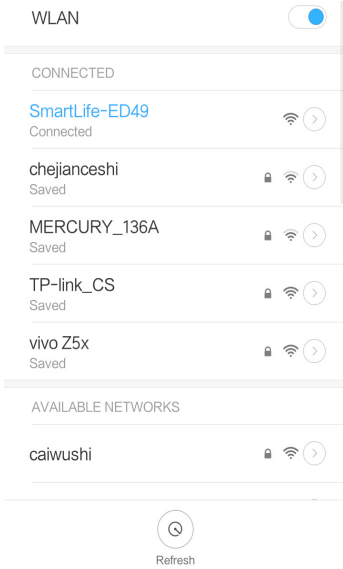

## **FCC NOTICE:**

This device complies with part 15 of the FCC Rules. Operation is subject to the following two conditions:

- (1) This device may not cause harmful interference
- (2) This device must accept any interference received, including interference that may cause undesired operation.

The manufacturer is not responsible for any radio or tv interference caused by unauthorized modifications or change to this equipment. Such modifications or change could void the user's authority to operate the equipment.

This equipment has been tested and found to comply with the limits for a Class B digital device, pursuant to part 15 of the FCC Rules. These limits are designed to provide reasonable protection against harmful interference in a residential installation. This equipment generates, uses and can radiate radio frequency energy and, if not installed and used in accordance with the instructions, may cause harmful interference to radio communications. However, there is no guarantee that interference will not occur in a particular installation. If this equipment does cause harmful interference to radio or television reception, which can be determined by turning the equipment off and on, the user is encouraged to try to correct the interference by one or more of the following measures:

- Reorient or relocate the receiving antenna.
- Increase the separation between the equipment and receiver.
- Connect the equipment into an outlet on a circuit different from that to which the receiver is connected.
- Consult the dealer or an experienced radio/LV technician for help.

### **RF Warning statement:**

To maintain compliance with FCC's RF exposure guidelines, this equipment should be installed and operated with a minimum distance of 20cm between the radiator and your body.

Distributed by:  
Electus Distribution Pty. Ltd.  
320 Victoria Rd, Rydalmere  
NSW 2116 Australia

[www.electusdistribution.com.au](http://www.electusdistribution.com.au)

Made in China