

# ROKR

## CONSTELLATION CLOCK

LC601

3D WOODEN PUZZLE

MECHANICAL MODELS

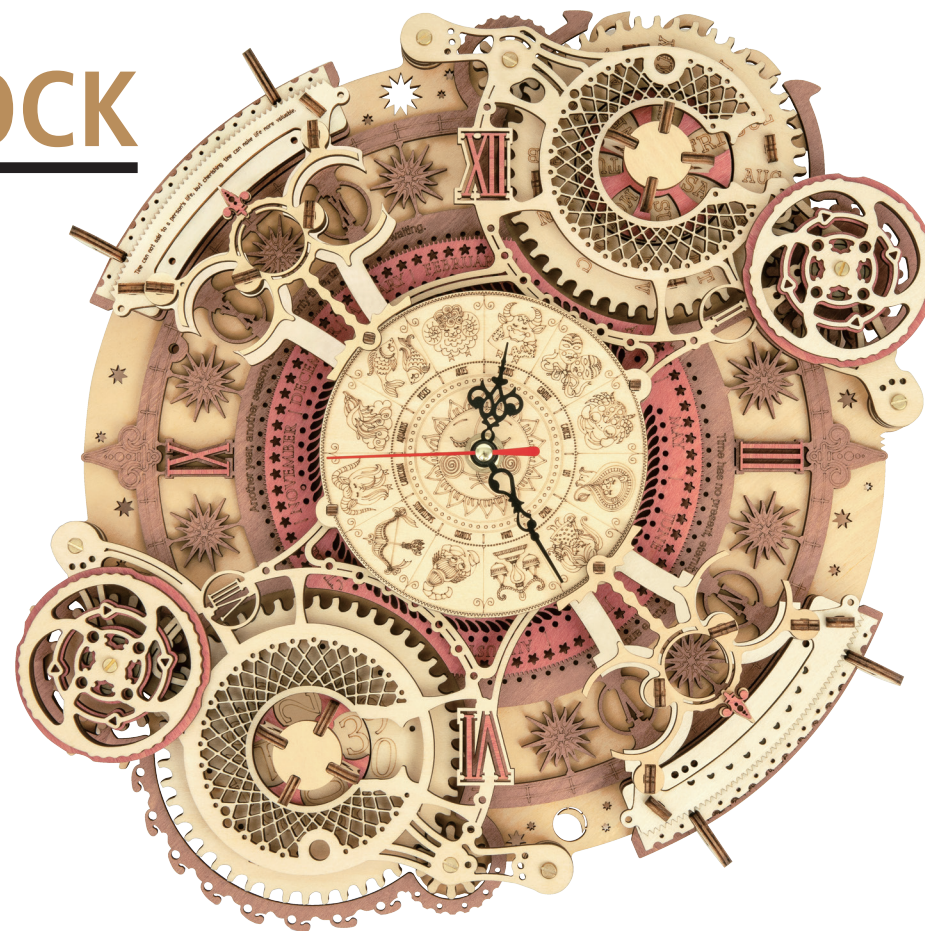

# ASSEMBLY INSTRUCTION

### WARNING:

The product is for people who **include and over 14 years old**. Kids should assemble under the guidance of adults.

### MAINTENANCE:

1. Keep the product away from the source of ignition and water to prevent any damage.
2. Don't use chemical reagents like alcohol, ammonia water to clean the product.
3. Use clean and soft fabric to clean the product if necessary.

### ATTENTION



Product Display

1. **Take off the pieces** from the board according to each step **before assembling**, and place them properly in case of missing.
2. According to the instructions when you assemble all the pieces. **Keep properly the instructions and validated after assembly.**
3. Polish the parts with sand paper, **enhance aesthetic feeling** and gear lubrication.
4. **Repair with glue** prepared by yourself if the wooden pieces would be break.
5. There are letters on some parts as shown, **assemble them together with same letters.**
6. Scan the **QR code** with remind for assembly video.
7. There is a little different from several parts and the pictures on instruction, **subject to parts number.**
8. There are **spare parts** on wooden board.

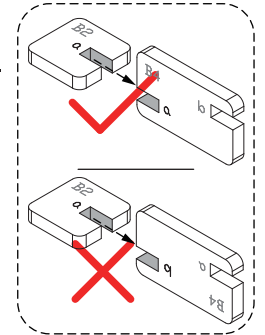

### \*CUSTOMER SERVICE

ROKR Facebook: [@rokrofficial](#) Email: [service@robotime.com](mailto:service@robotime.com)

Please contact us on Facebook or email if you have any questions.

### FAQ:

| Problem                                   | Cause  | Solution   |
|---|--|--|
| Gears couldn't be rotate or just be idli. | <ol style="list-style-type: none"><li>1. Missing waxing steps.</li><li>2. The square nut is too tight.</li></ol> | <ol style="list-style-type: none"><li>1. According No.4 and No.5 assembly steps, waxing the parts as shown.</li><li>2. Just fix the square nuts with brass screws, not to tight.</li></ol> |
| Knob couldn't be rotate.                  | <ol style="list-style-type: none"><li>1. Wrong direction of rotation.</li></ol>                                  | <ol style="list-style-type: none"><li>1. Two large knobs rotate clockwise and two small knobs turn counterclockwise.</li></ol>   |





Ensure the connection of gears smoothly



Fix with glue

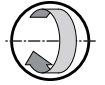

Flip to assemble.



Wax the gray parts with remind



Printed side



Blank side



Special attention in assembly



Complete 2 same parts













Step 1





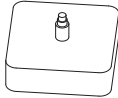



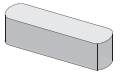
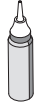

Step 2

## Parts List

\*Due to customs policy in international shipping, the wax and glue may not be included. Please prepare them yourself.

| Item         | Slotted Brass Screw  | Slotted Brass Screw  | Slotted Brass Screw  | Square Nut  | Hex Nut   | Metal Washer  | Rubber Gasket   | Movement  | Second Hand   | Minute Hand   | Hour Hand   |
|--------------|--|--|--|---|---|---|---|---|---|---|---|
| Number       | P1   | P2   | P3   | P4  | P5  | P6  | P7  | P8  | P9  | P10   | P11   |
| Illustration |  25mm |  28mm |  35mm |  |  |  |  |  | <br>(Subject to the material object) | <br>(Subject to the material object) | <br>(Subject to the material object) |
| Quantity     | 2  | 6  | 2  | 10  | 1   | 1   | 1   | 1   | 1   | 1   | 1   |

| Item         | Wax   | Glue  | Sandpaper   | Round Nut   | Hex Nut   | Adhesive Hook   | Nails   | Hook  | <b>Introduce:</b><br> This is C1 spare parts<br><hr/>  This is E5 spare parts<br><hr/> <b>Attention:</b> a1 b1 c1 are general small parts with lowercase letters. |
|--------------|---|---|---|---|---|---|---|---|--|
| Number       | P12   | P13   | P14   | P15   | P16   | P17   | P18   | P19   |  |
| Illustration |  |  |  |  |  |  |  |  |  |
| Quantity     | 1   | 1   | 1   | 1   | 1   | 1   | 1   | 1   |  |

1

A3

a3 x2  
a4 x2

C1 x4

B3

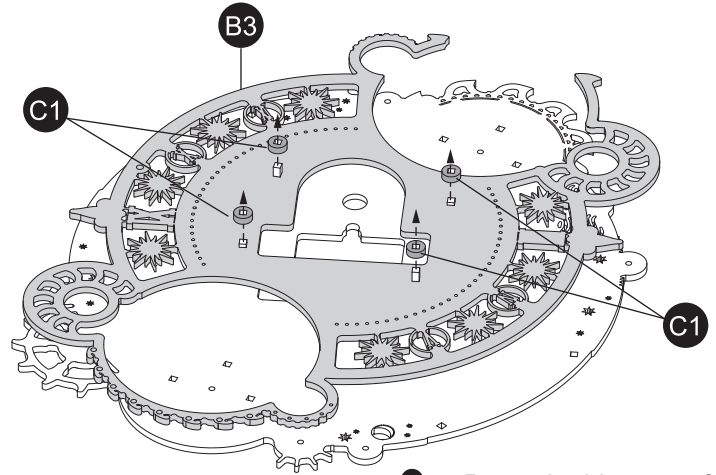
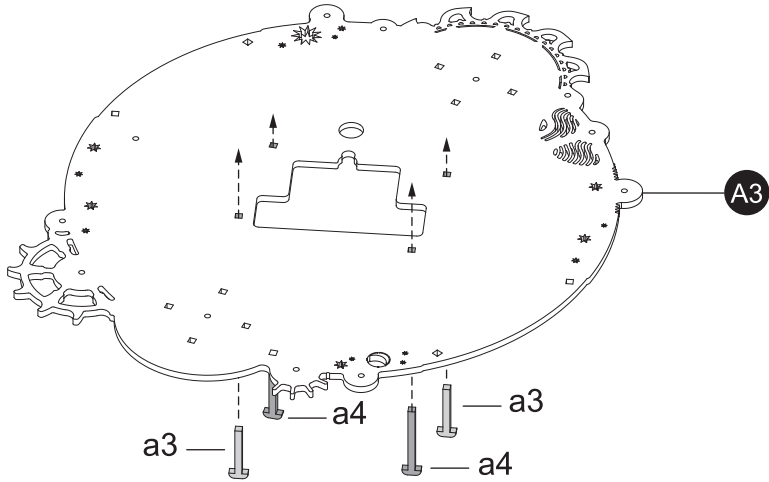

Press the big area of B3 to keep the parts complete when take off it from the board.

C1 x4

E1

B1

b1 x4

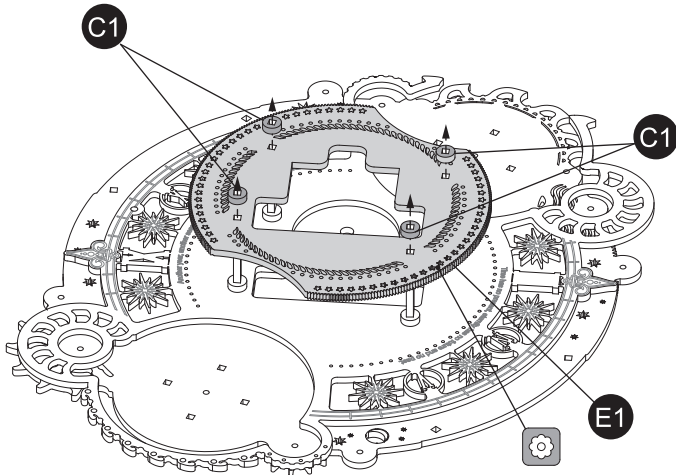

The assembly direction of ratchet wheel is consistent with the diagram.

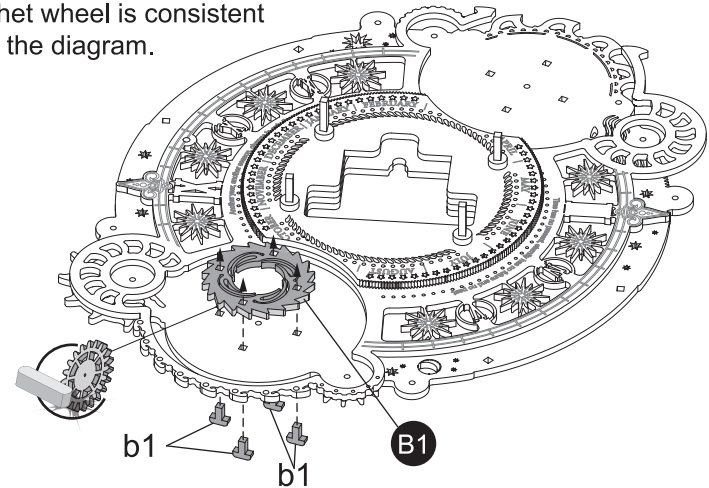

**B1**

b1 x4



The assembly direction of ratchet wheel is consistent with the diagram.

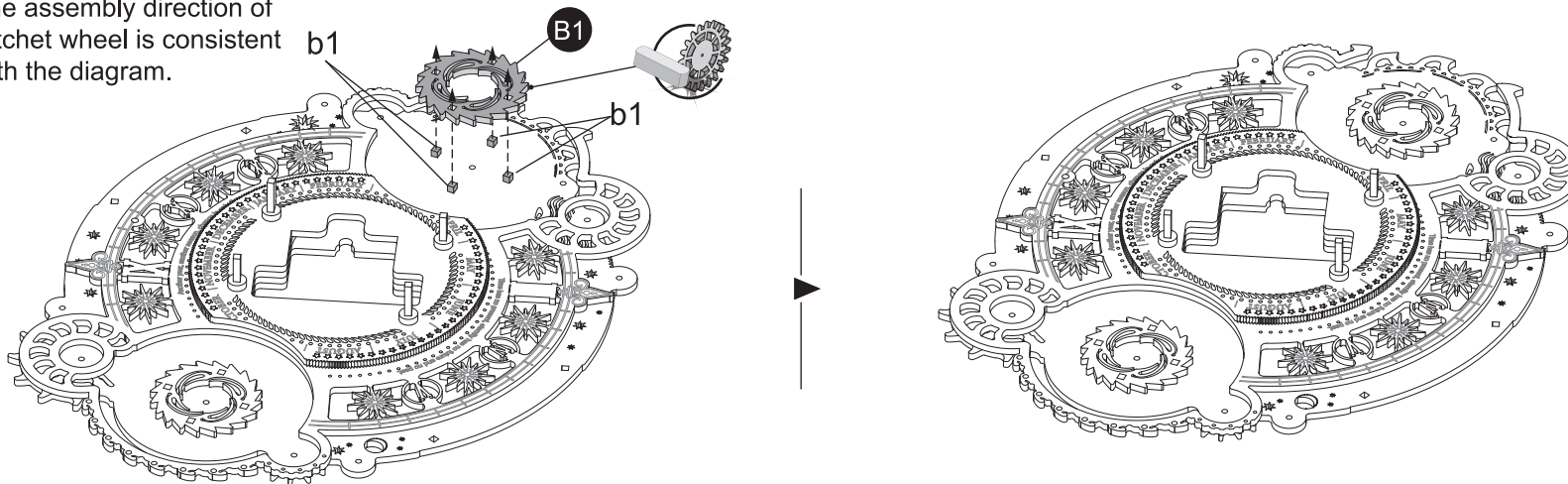

**2**

**C17**

**P1**

**E4**

**C18**

**A4**

**A5**

**C19**

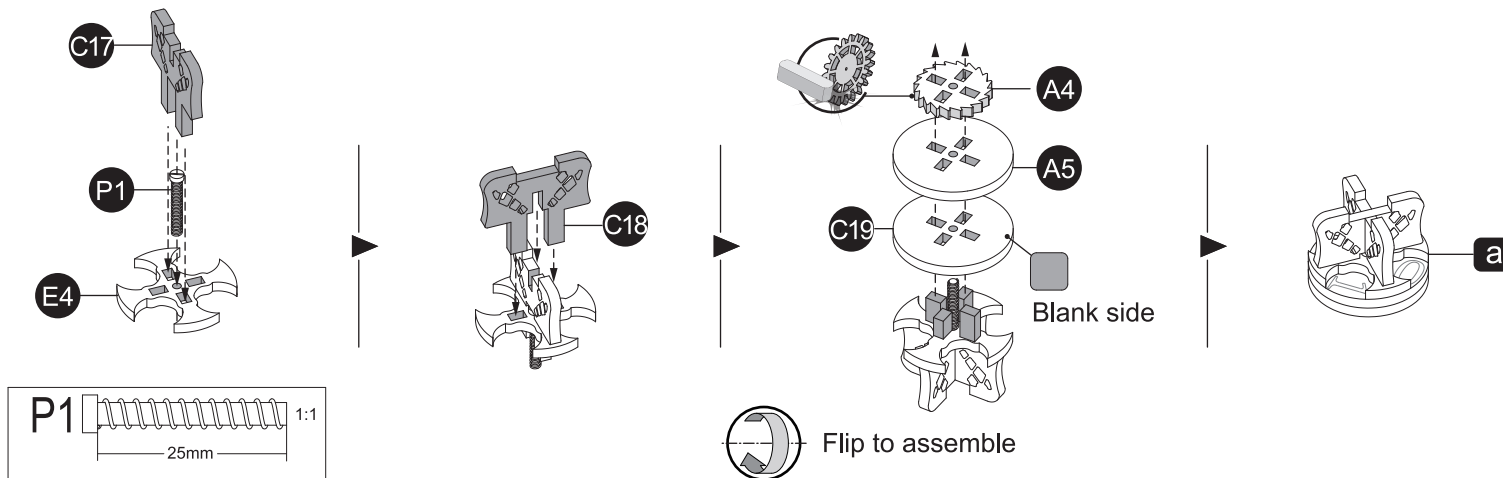

D7  
P1  
E2

D9  
D8

B8  
B7

C20

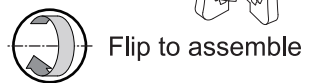
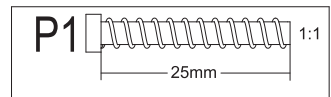
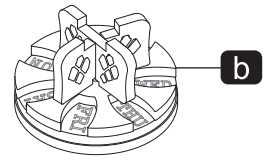
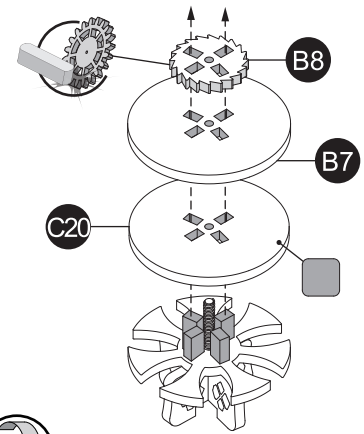
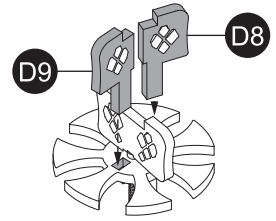
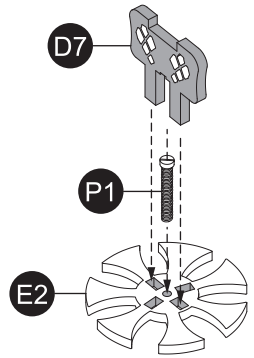

3

c1 x4

C12

B9

A8

c2 x4

C11

B9

B4

**!** The assembly direction of ratchet wheel is consistent with the diagram.

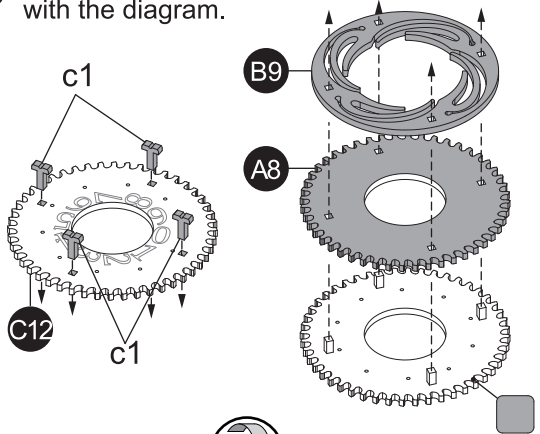

**!** The assembly direction of ratchet wheel is consistent with the diagram.

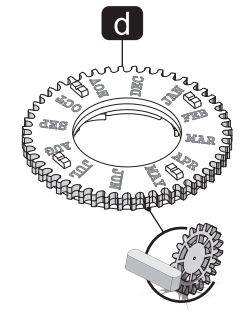
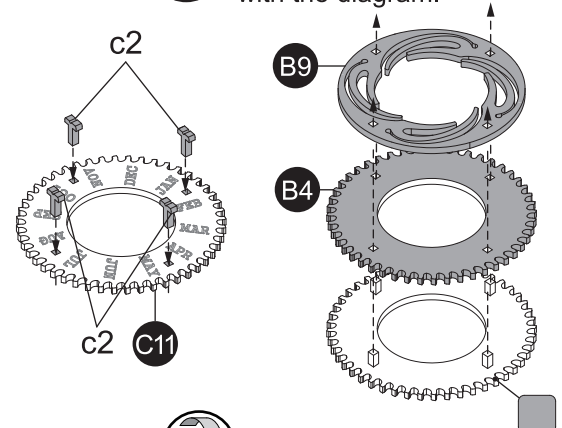





Ensure the connection of gears running smoothly.

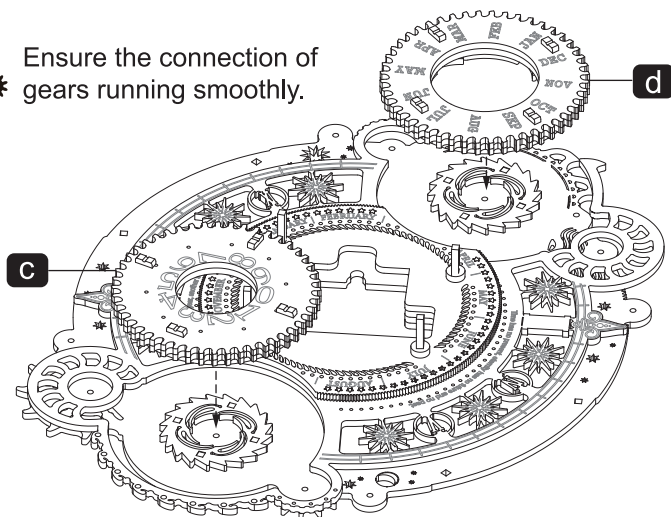

Ensure the connection of gears running smoothly.

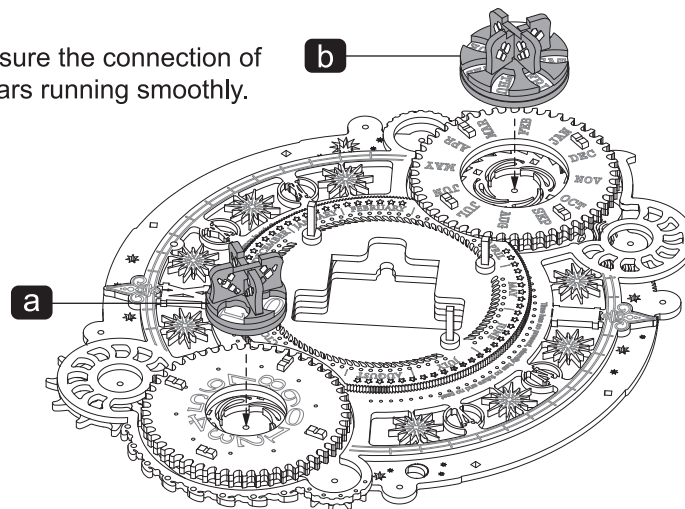

4

E3

C3 x4

C5 x2

A7

C2

C6

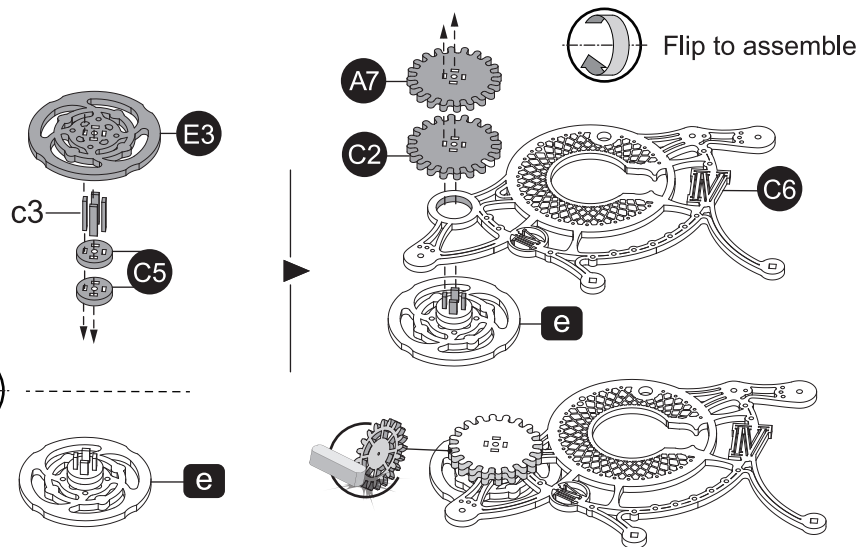
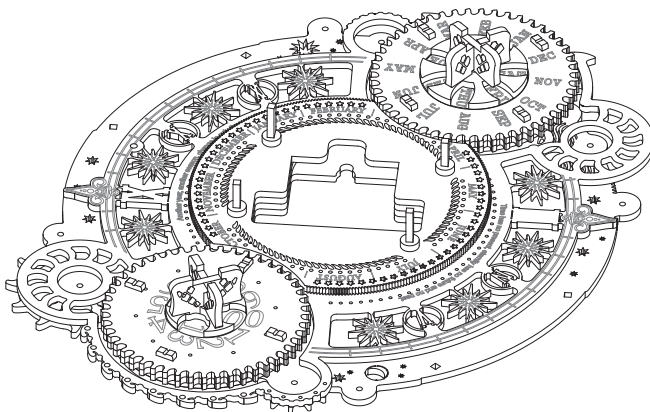

P3

C16

C9 x2

C13 x6

C14 x4

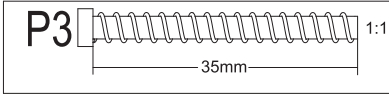
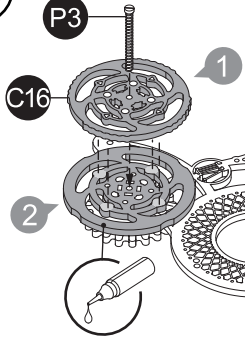

Need glue in moderation



The part rotation mark is consistent with the arrow.

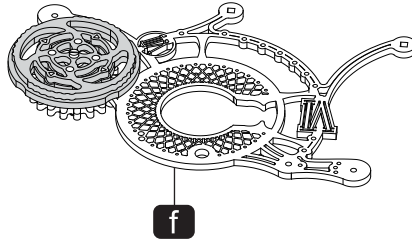

Rotate the painted parts and ensure the gear below moving with them.

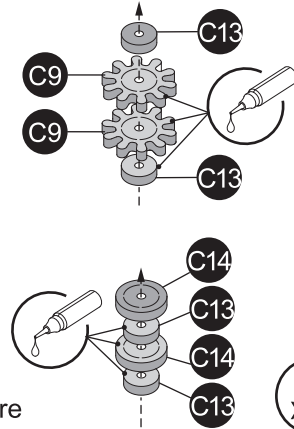

x2

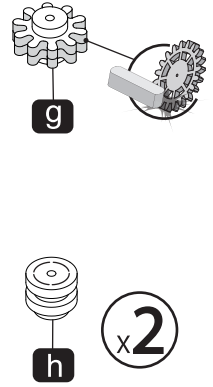

x2

C4

P2 x3

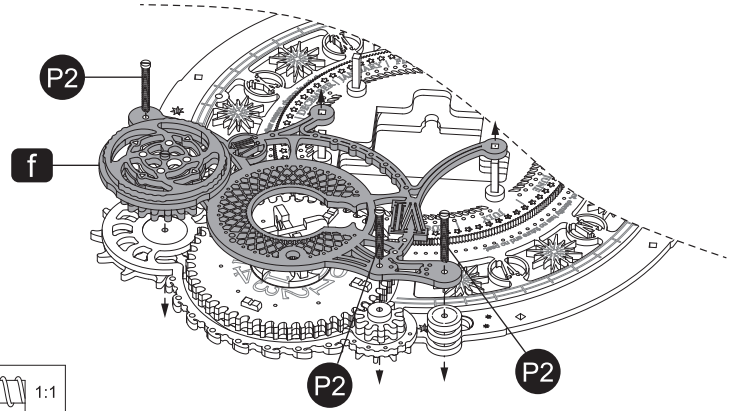
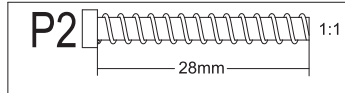
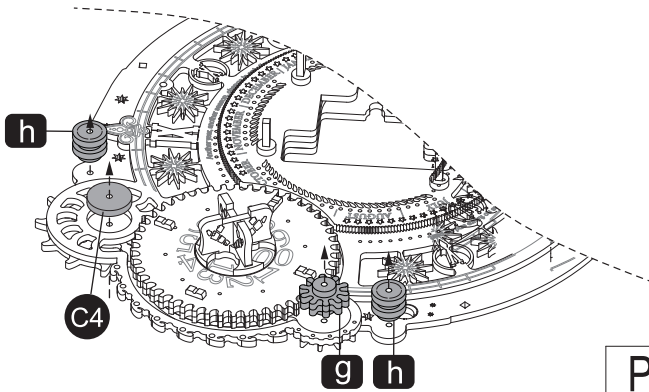

P4 x5

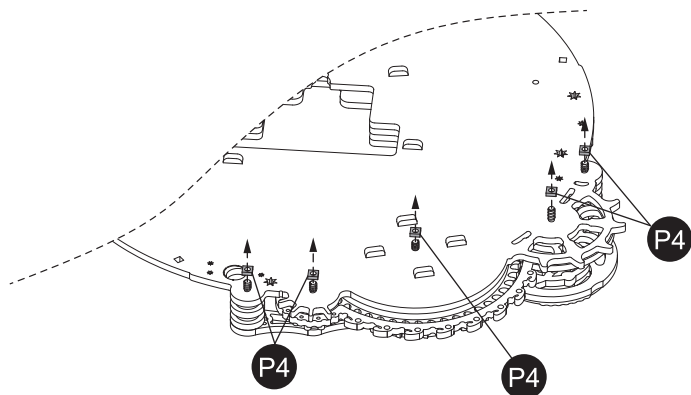

Ensure the connection of gears running smoothly.

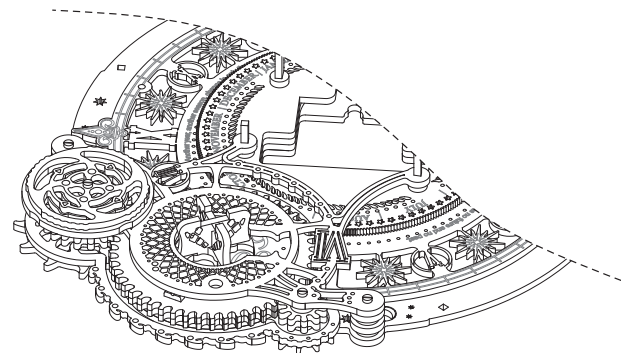

5

E3

C3 x4

D3 x2

B5

C2

C8

P3

C16



Flip to assemble

B5

C2

P3

1:1  
35mm

P3

C16

1

2

i

Need glue in moderation



The part rotation mark is consistent with the arrow.



Rotate the painted parts and ensure the gear below moving with them.

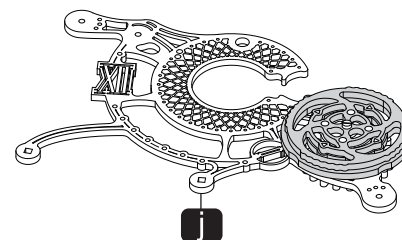
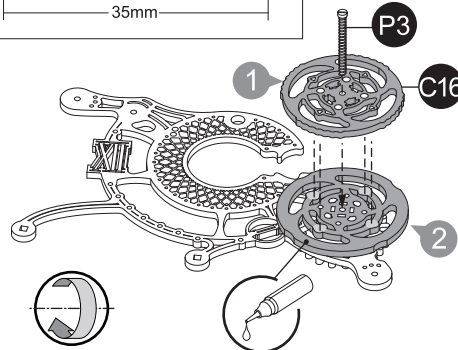
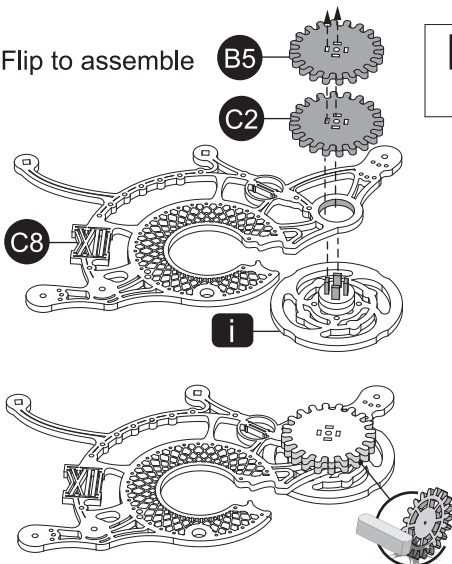
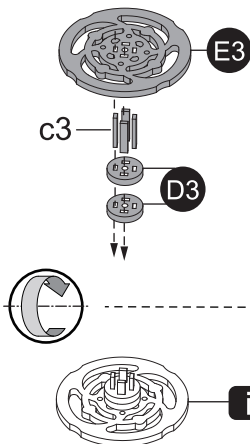

D13 x2

D6 x6

D10 x4

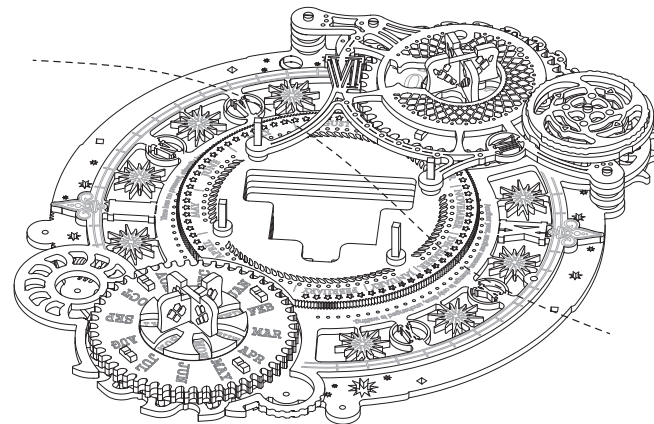
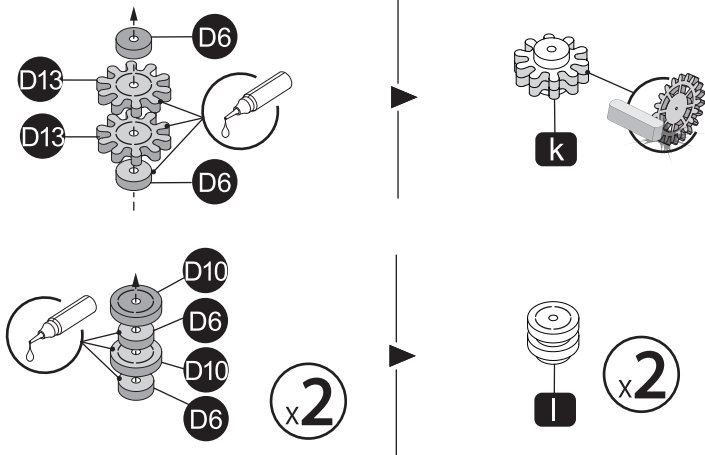

D2

P2 x3

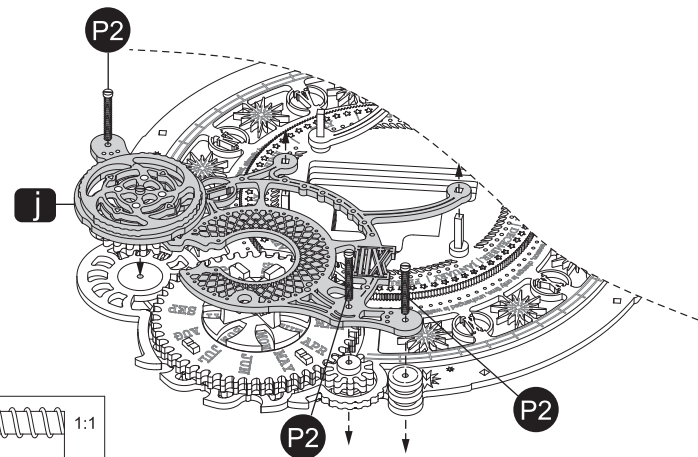
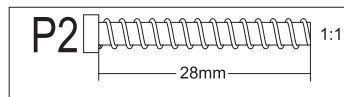
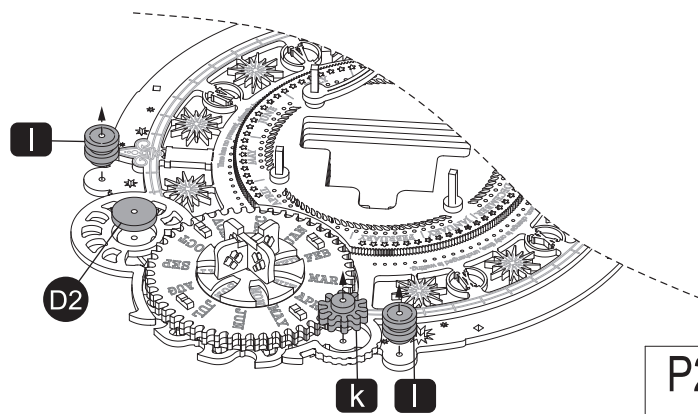



P4 x5

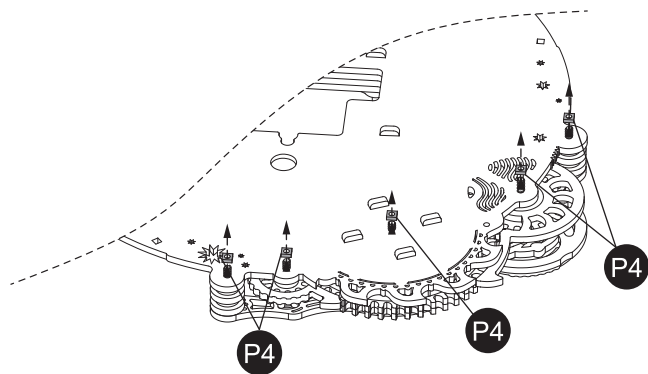

Ensure the connection of gears running smoothly.

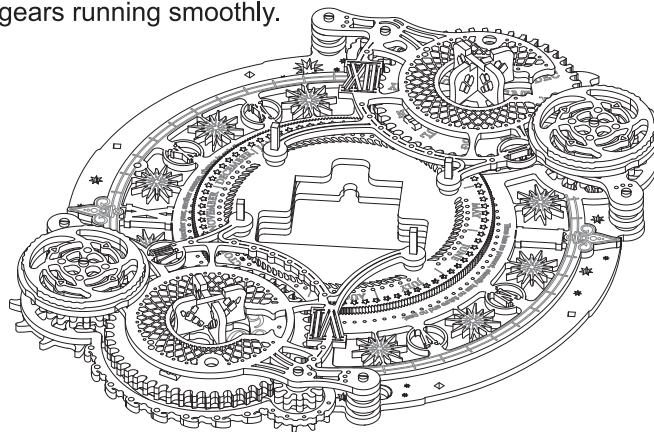

6

d2 x2

D14

D11

D12

C1 x4

B2

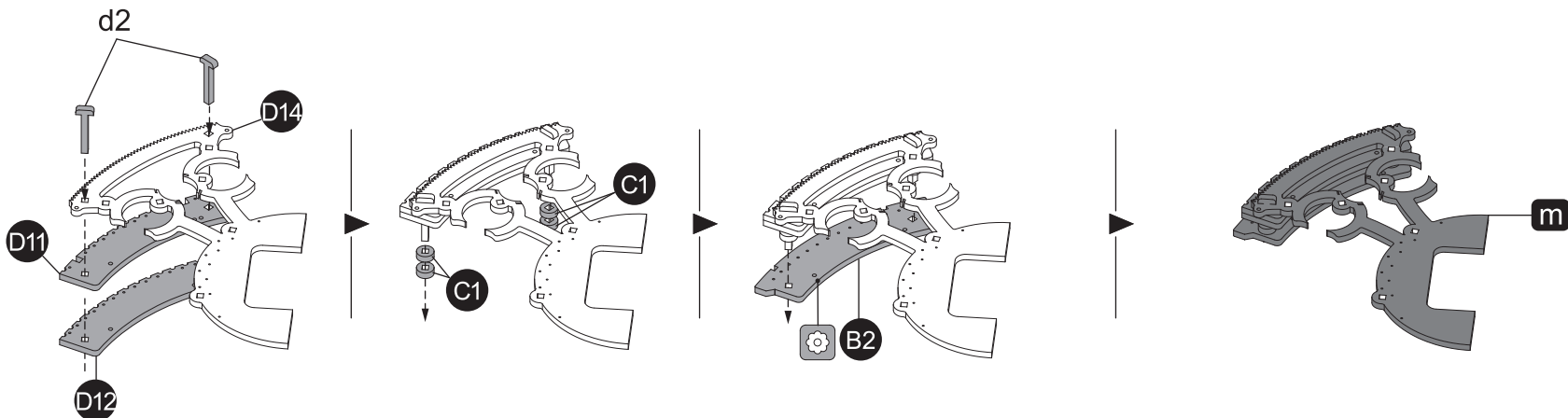

- D1**
- d1 x2
- D5**
- D4**
- C1** x4
- B6**

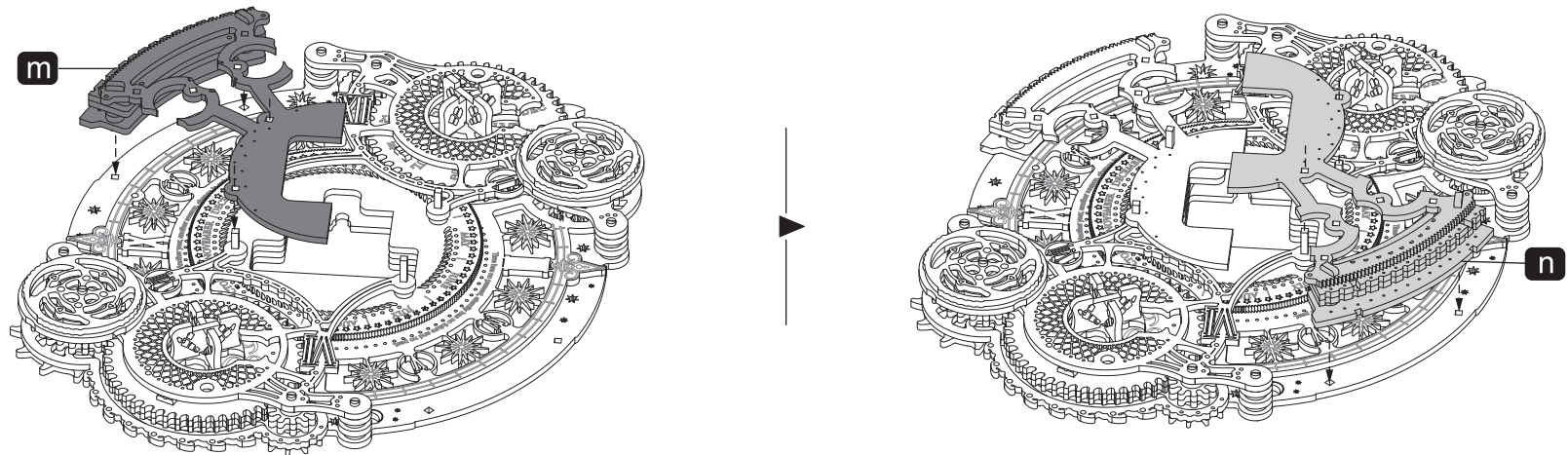
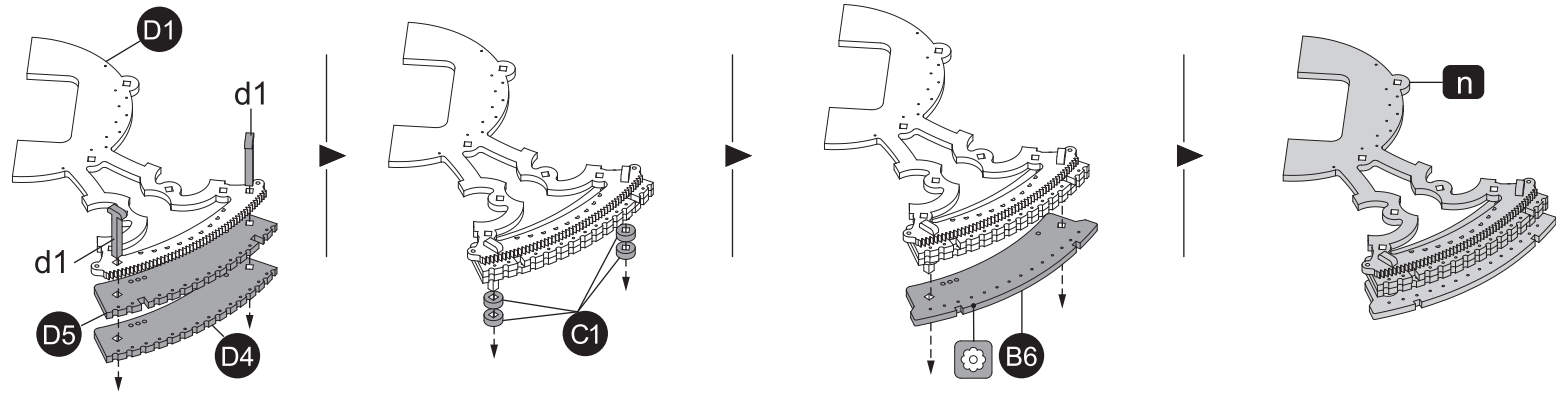

C10

C3

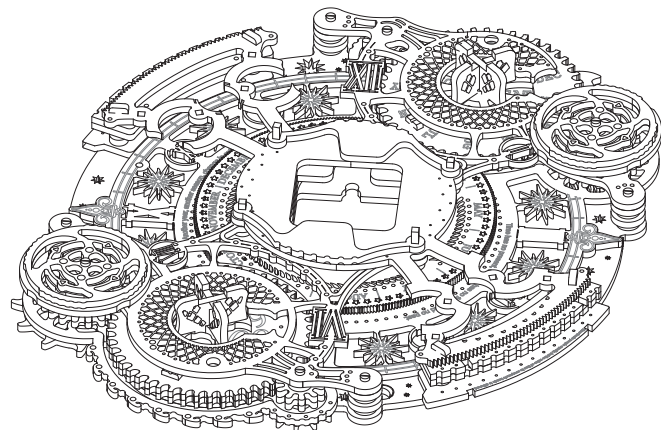
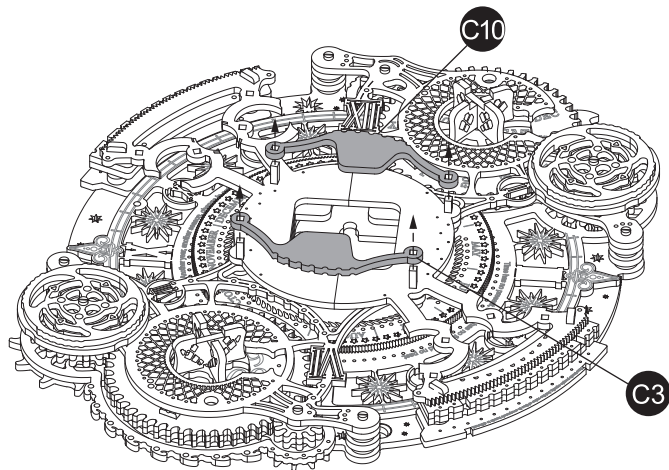

7

F1

P5

P6

P7

P8

P9

P10

P11

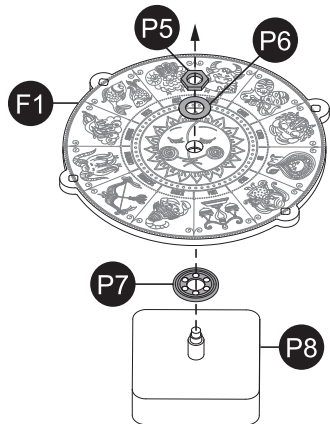

Remove the protective film on watch hand.

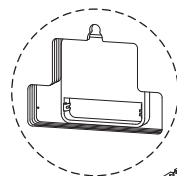
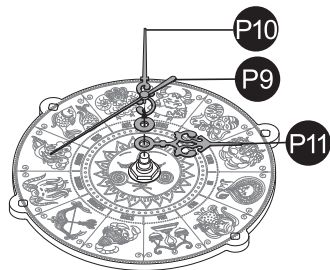
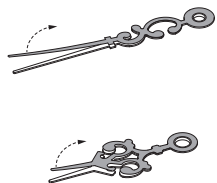

Insert the movement as shown.

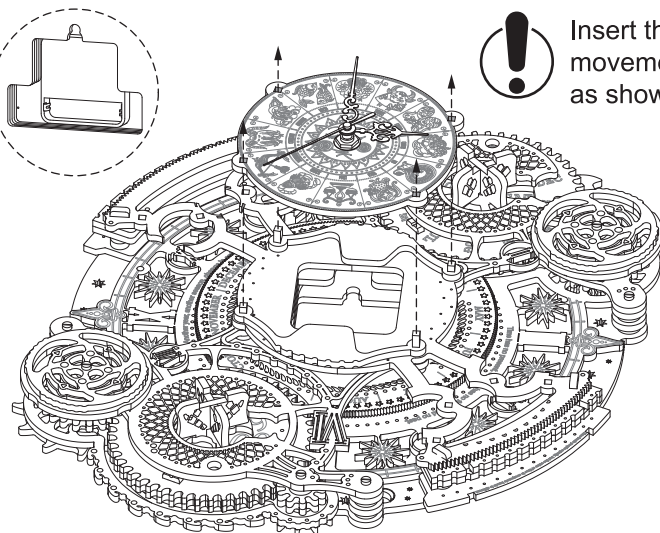

a1 x4

C1 x8

A1

a2 x4

C1 x8

A9

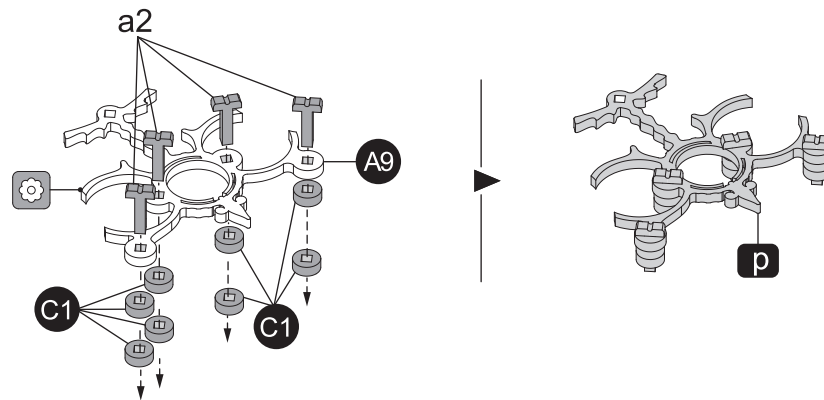
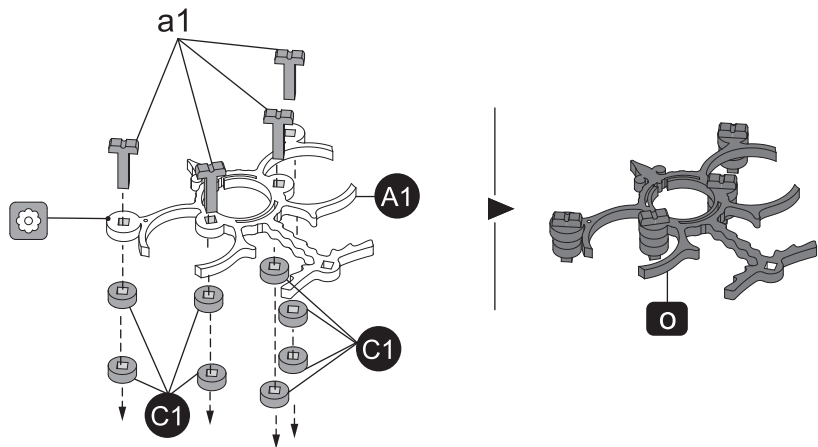

A2

A6

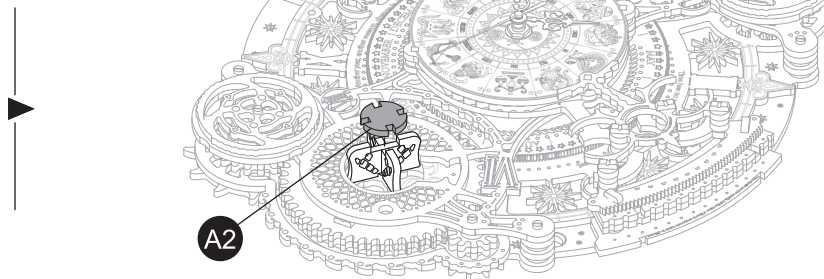
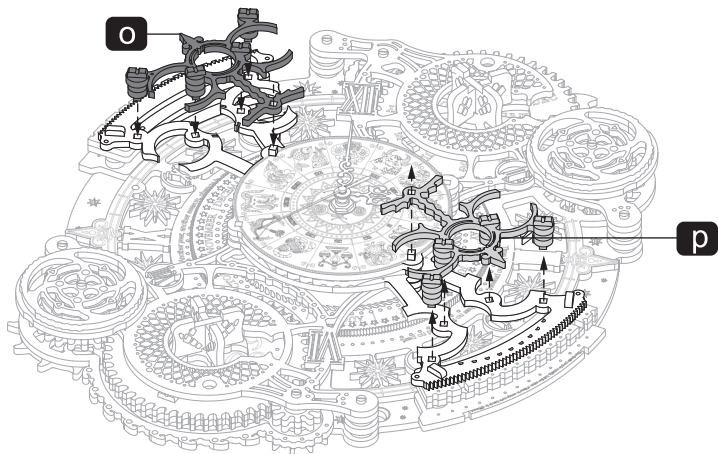



E5 x2

E6

E7

E8

E9

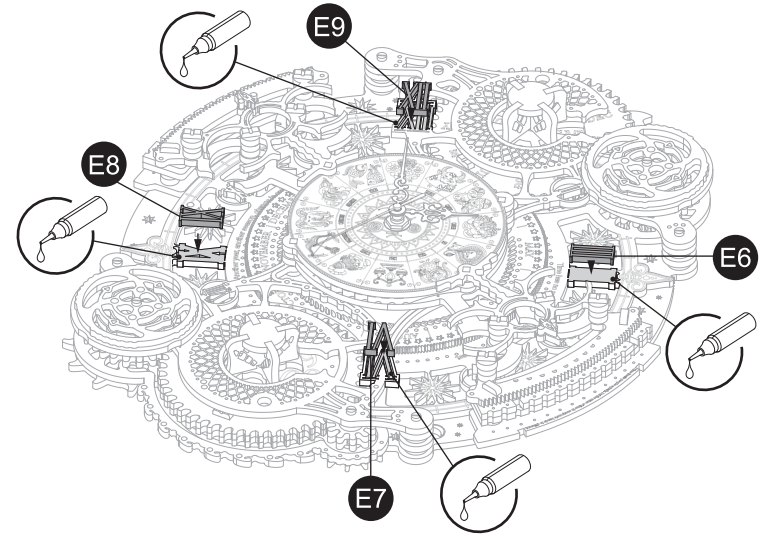
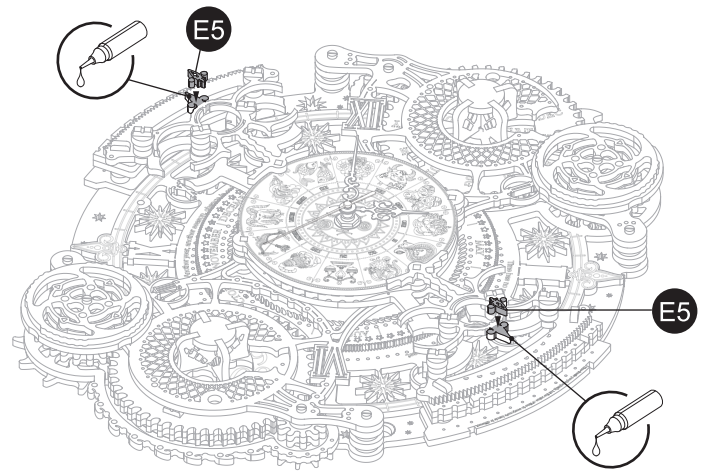

C15 x2

C7 x2

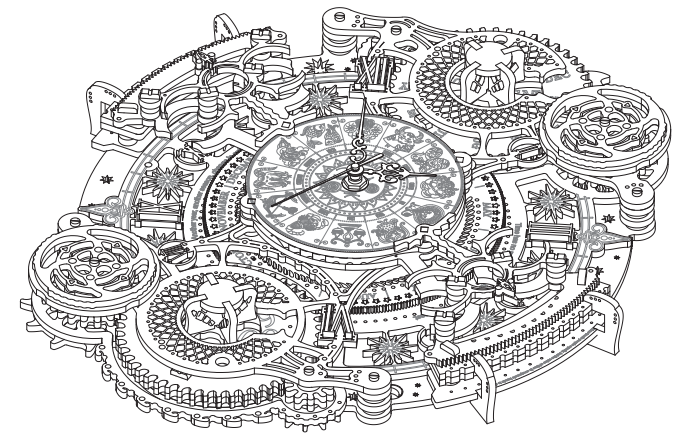
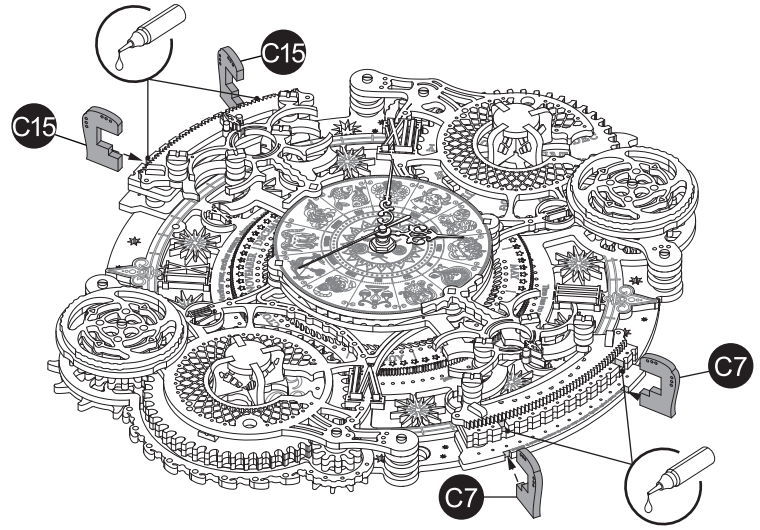

Battery Installation:

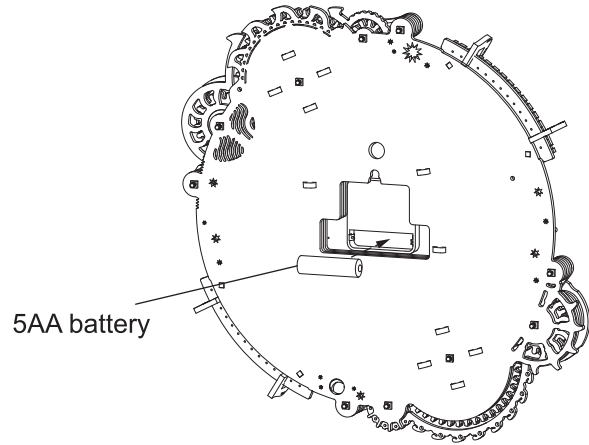

Install the battery

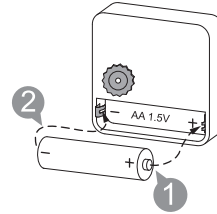

Remove the battery

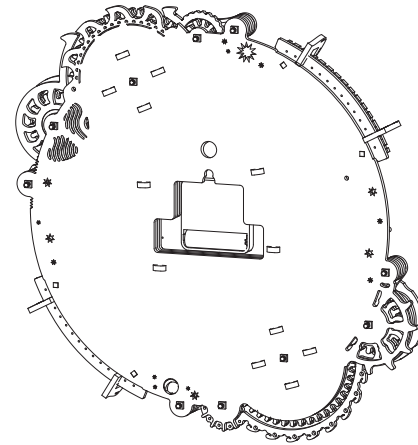
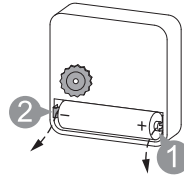

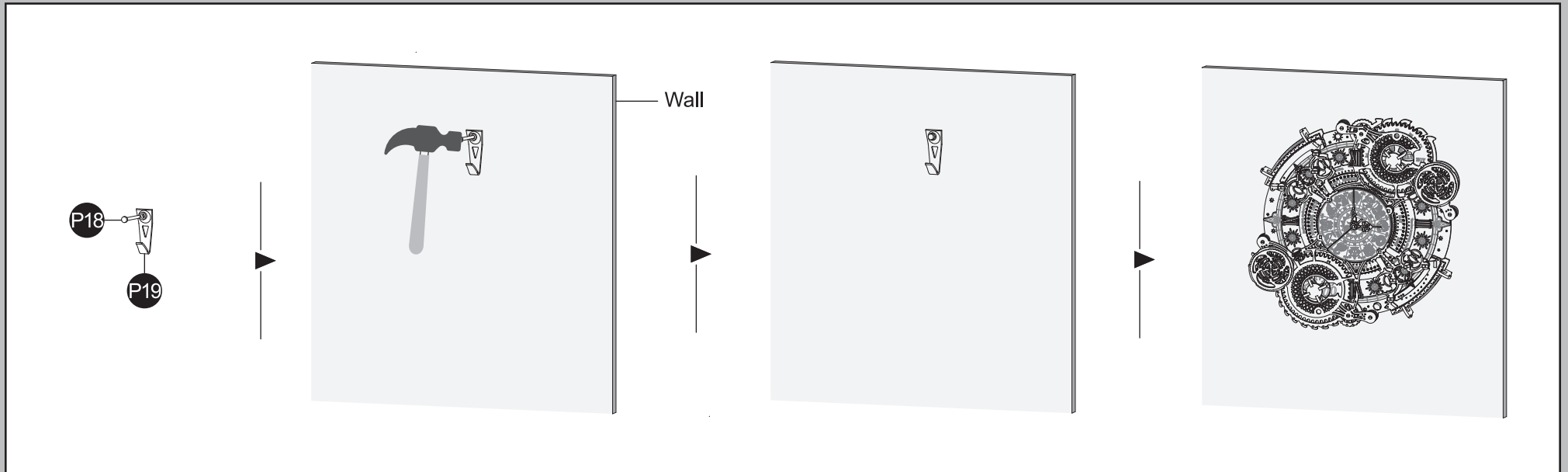

Method one:

**Choose metal hook**

- Applicable wall: Wooden wall, lime wall, wall covered with wall paper. (There will be small holes on the wall.)
- Inapplicable wall: Wall which can't be nailed.
- Weight capacity: 15kg.
- Attention: Need parents' help. Choose the correct hook and knock the nail into the correct wall.

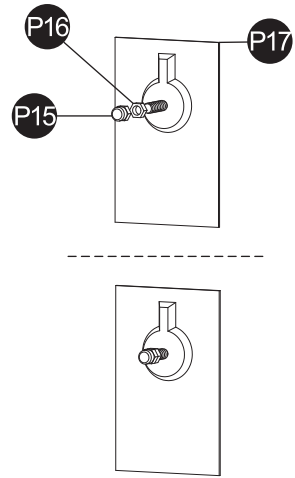

Remove protective film

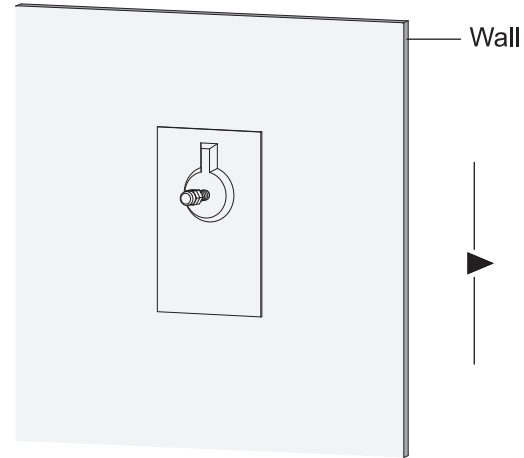
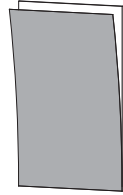

Method two:

**Choose glue hook**

- Applicable wall: ceramic tile, stainless steel, glass. (Hard to remove after sticking.)
- Inapplicable wall: Uneven wall, wall with coating.
- Weight capacity: 6kg.
- Attention: clean the place where you would like to stick. Press the hook to squeeze the air and waiting 8 hours after sticking.



### Constellation clock Operating Instruction:

- 1.The lower left part could be adjustable days.
- 2.The upper right part could be adjustable months and weeks.
- 3.Rotate gears of movement to adjustable the time.

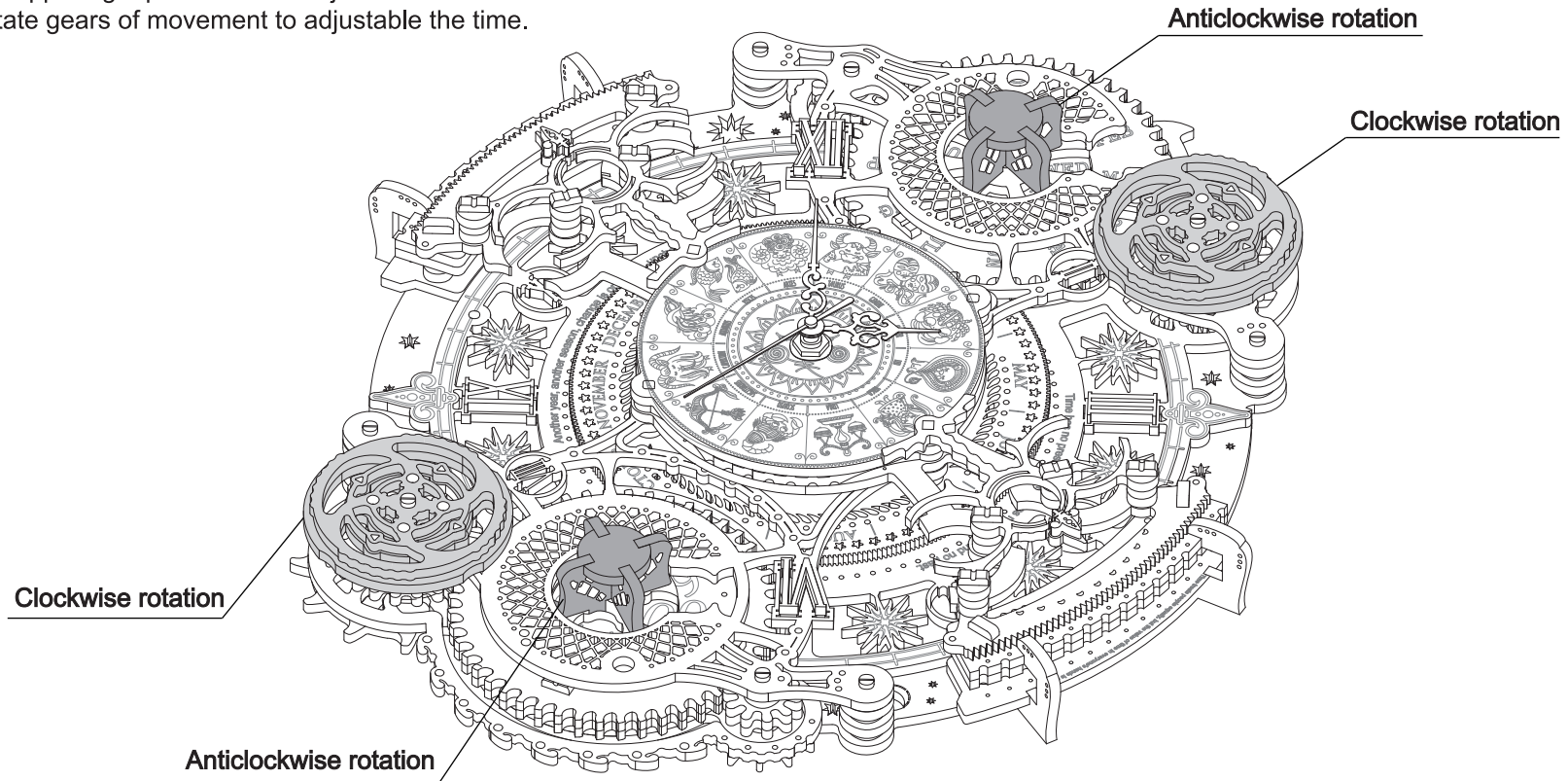

Gears couldn't be rotate or just be idli:

- 1.Missing waxing steps, according No.4 and No.5 assembly steps, waxing the parts as shown.
- 2.Just fix the square nuts with brass screws, not to tight.

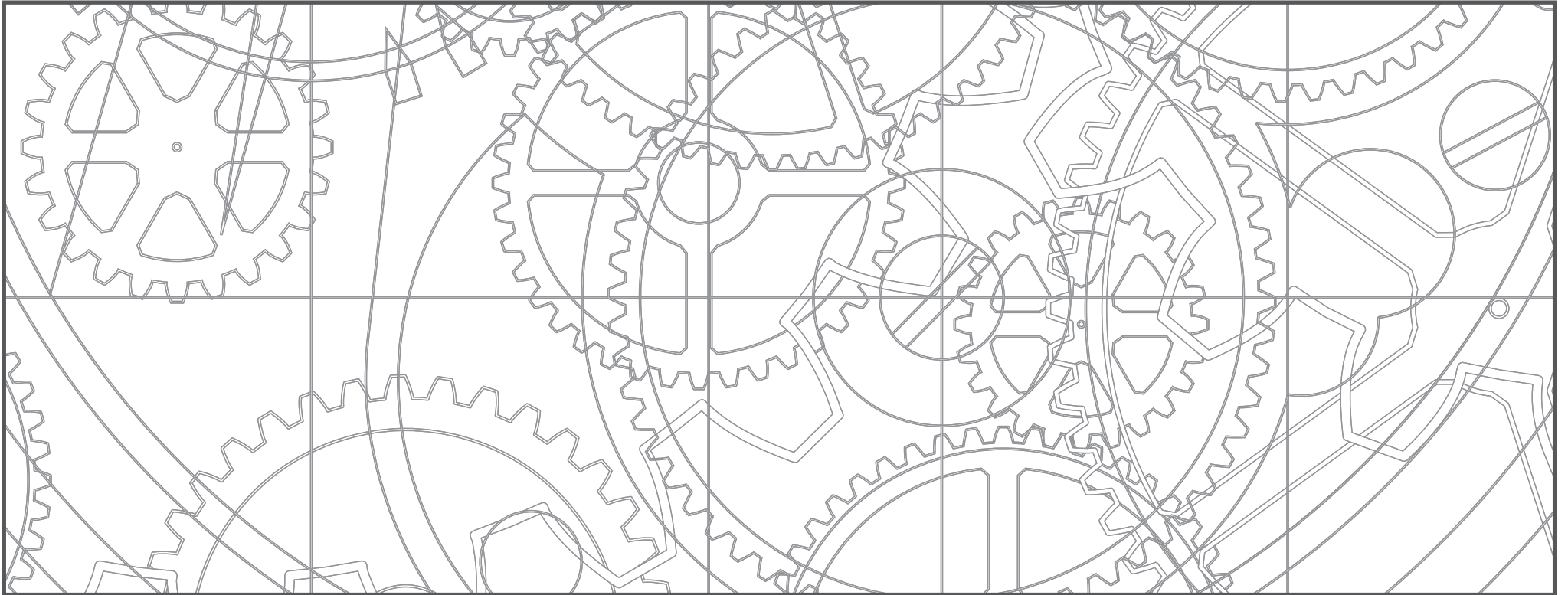

Find us on Facebook & Youtube.  
*Visit [www.robotime.com](http://www.robotime.com) for more new designs.*