

V1

User Guide

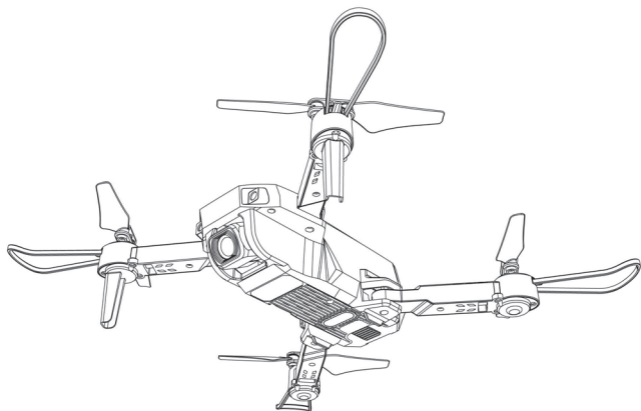

Content

Product Description	
Introduction	1
Prepare the Aircraft	1
Prepare the Transmitter	2
Parts Name	3
Aircraft	
Power Switch of the Aircraft	4
Aircraft Battery	4
Assemble & Disassemble the Propellers	5
Transmitter	
Transmitter Function	6
Transmitter Joystick Mode	9
How to Fix the Phone	9
M-DRONE App	
FPV Real Time Transmission Software	10
Flight	
Surroundings Requirements of the Flight	11
Pre-Flight Inspection	11
The Operation of Aircraft	11
Basic Flight	13
Appendix	
Packing List	14
Important Statement	15
Safety Precautions	15

Product Description

Introduction

The V1 aircraft with a high definition camera, adopts a completely fold-able structure, is easy to carry. The transmitter with lots of function buttons, can achieve various operations and settings of the aircraft and camera. Through the APP in the phone, it displays a high-definition images in real time transmission. The pull-out bracket design of transmitter makes it easy to carry and store. The gimbal can be manually adjusted before flying to get a better shooting angle.

Prepare the Aircraft

Expand the arm

The aircraft is in folding state during shipping, please unfold it according to below instruction.

1. Expand the upper arm out Firstly.
2. Use the same method to unfold other arms.

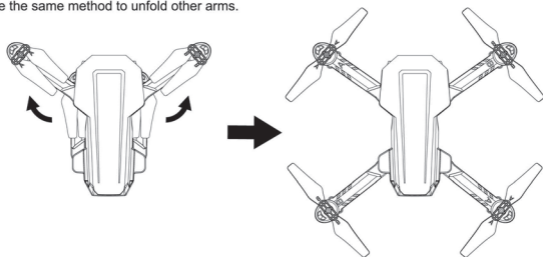

Assemble protection frame

Install the protection frame on the arm.

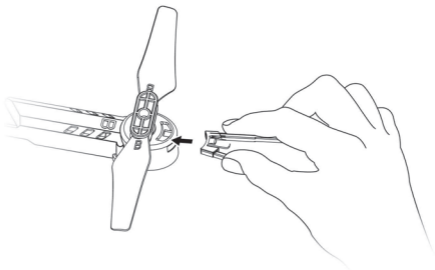

Install aircraft's battery

Push the battery into the aircraft's battery box, check and make sure that the battery is installed accurately.

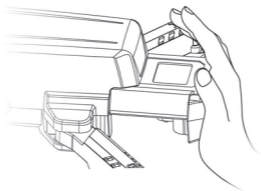

Reminder: If the battery is not installed properly, it may cause the aircraft to fall down due to power failure.

Prepare the Transmitter

Install the battery of remote controller

Open the battery box, insert 3*AAA batteries correctly according to the polarity in transmitter, then close the battery box.

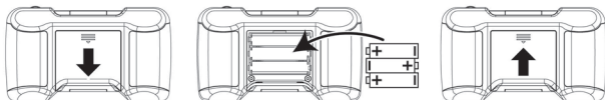

- The transmitter use 3*AAA Non-chargeable batteries or AAA chargeable batteries. (Please purchase)
- Please notice the polarity during install or change the batteries.
- Non-chargeable battery cannot be charged, only use the batteries the same with the recommended ones.
- Please take out the chargeable batteries before charging.
- Forbid to connect the aircraft with higher than the recommended power batteries.
- Do not mix the old and new different type batteries.
- Please take out the exhausted batteries in time, discarded batteries cannot be littered.
- In order to avoid battery leakage causing damage to the aircraft, please take out the battery if not in use for a long time.

Parts Name

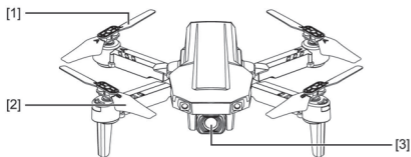

- [1] Propeller A
- [2] Propeller B
- [3] Camera

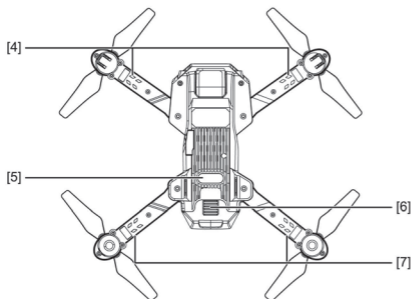

- [4] Front arm
- [5] Power switch
- [6] Battery
- [7] Rear arm

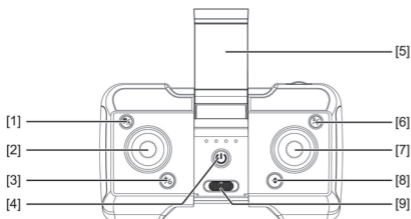

- [1] Take picture/video
- [2] Left joystick
- [3] Headless mode/
Trimmer
- [4] Power switch
- [5] Phone holder
- [6] High speed rotation/
Orbit
- [7] Right joystick
- [8] One key to take
off/Landing
- [9] High/Slow speed
switch

Aircraft

Power Switch of the Aircraft

Press and hold the power switch of the aircraft to turn on the aircraft. At this time, the indicator lights of the aircraft flash; press and hold the power switch again to turn off the aircraft and the indicator lights go out.

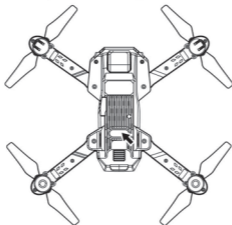

Aircraft Battery

The V1 is equipped with high energy battery. The capacity of the battery is 730mAh and the rated voltage of 3.85V.

Charging

Please charge the battery fully before using it. Be sure you use the officially supplied USB charging cable to charge. The charging time is about 100 minutes.

*The above charging data is based on 5V 1A adaptor. Using the different adaptor will affect the charging data. Recommend using 5V 1A adaptor to charge.

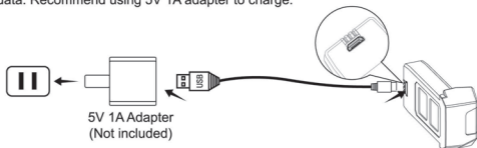

- Please charge the battery under adult supervision. Do not let children to charge it alone. Keep away from flammable materials when charging, pay attention on the aircraft, do not leave it beyond your monitoring range.
- Please do not make the battery short-circuit or squeeze the battery to avoid explosion.
- Forbid to take the power cord out from the aircraft. Do not make the power cord short-circuit. Forbid to make the battery short-circuit, disassemble or throw into fire. Do not put the battery in high temperature or near heated places (such as fire or electric heating devices).
- Please check the charger's power cord, plug, shell and other parts regularly, if any damage, please fix first.
- Please use the charger indoor only.
- After the flight, the battery should be charged to 50% before storage (means fly a half of the total flight time after fully charged). If not using for a long time, it is recommended to charge and discharge at least once per month. It can prevent the battery from being over-discharged, causing permanent damage.

Assemble & Disassemble the Propellers

Assemble/disassemble the propellers

●Assemble

Select corresponding propellers, (A and A, B and B), use screwdriver to fix the 2 screws clockwise (as pic 1-2).

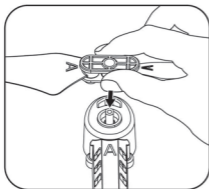

Pic. 1

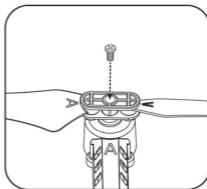

Pic. 2

●Disassemble

Turn screwdriver anti-clockwise, take out 2 screws then pull out the propellers (as pic.3-4).

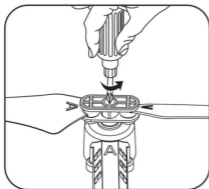

Pic. 3

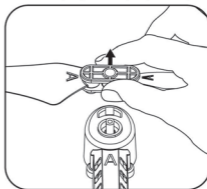

Pic. 4



- Please ensure that the clockwise and anti-clockwise propellers are installed correctly, otherwise the aircraft cannot fly.
- As the propeller is thin, please be careful during installation, lest any accidental scratches.
- Please use the official propellers.
- Propellers are consumable, if necessary, please purchase accessories separately.

Transmitter

Transmitter Functions

Photo/Video

Short press the "📷" button on transmitter to take photo.

Long press the "📷" button on transmitter to take video, Long press the "📷" again, the shooting will exit.

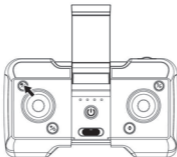

Headless mode

Short press the "📷" button to start the headless mode with the transmitter having a beep sound. In headless mode, after taking off, the aircraft forward direction will default as the aircraft nose direction. The corresponding back, left/right side flying will be locked accordingly. Long press this button again to exit headless mode.



Trimmer

During flight, press and hold the "📷" button, at the same time, push the joystick to control the trimmer direction.

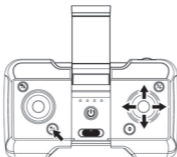

High speed rotation

Short press the " $\frac{\infty}{\infty}$ " button, the buzzer having a beep sound, the high speed rotation will start. The aircraft will rotate at high speed. Press the button again, the function will be canceled.

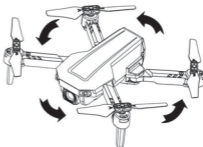
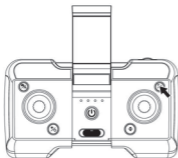

Orbit flight

Long press the " $\frac{\infty}{\infty}$ " button, the buzzer having a beep sound, the orbit flight will start. The aircraft will orbit in a counterclockwise direction. Press the button again, the function will be canceled.

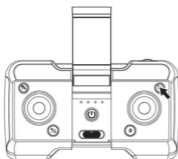

One key to take off/Landing

Short press the " \updownarrow " button, the aircraft will take off and fly to 1.5 meter height automatically, then hover. Press the button again, the aircraft will land on ground automatically.

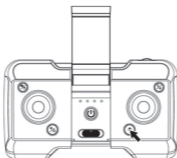

Emergency stop:

Press and hold the " \updownarrow " button for 2 seconds, the aircraft will land urgently.

Roll/Flip mode

Control the aircraft to rise to 2 meters or more height, press the right joystick of the transmitter to enter the roll mode. Push the right joystick to any direction, the aircraft will complete a 360° flip action in the corresponding direction.

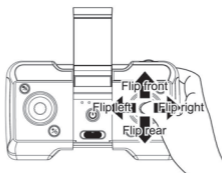

Note: If the aircraft battery is low, it cannot flip.

High/Slow speed switch

Toggle the high/slow speed switch in the transmitter, then the transmitter will have two beeps for high speed mode. (The default is low speed mode)

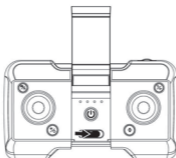

Tossing mode

After the code of aircraft matched, hold the aircraft in hand and throw it up and forward, then the four propellers of the aircraft will start and hover at a certain height.

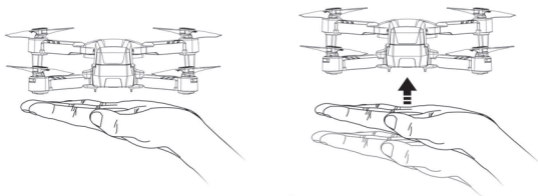

Transmitter Joystick Mode

Joystick mode

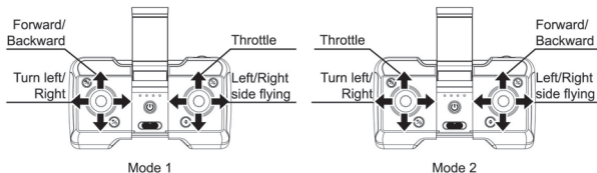

Joystick mode switch

Long press the transmitter "☰" button without releasing (Pic 1), then turn on the transmitter power switch (Pic 2), the transmitter will switch to another mode, the factory default mode is Mode 2.

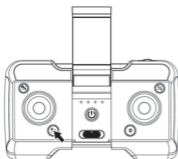

Pic. 1

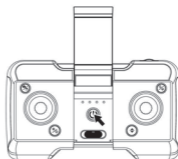

Pic. 2

How to Fix the Phone

1. Rotate the phone holder up 150° (Pic. 1);
2. Adjust phone fixing components, stretch up and down to adjust the size (Pic. 2).

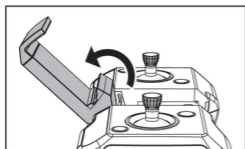

Pic. 1

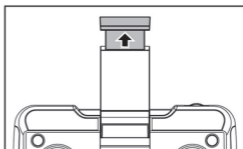

Pic. 2

M-DRONE App

FPV Real Time Transmission Software

Scan code to download App

- For Apple iOS system, please search for "M-DRONE" in App Store or directly scan the QR code to install.
- For Android phones, please scan the below QR code to install.



M-DRONE



Connection instructions

Enter the "Settings" option of the mobile phone, turn on the WIFI, find the name FPV_***** in the mobile WIFI search list, connect until the word "Connected" appears, indicating that the connection is successful and exit the setting options. Open the App on the phone.

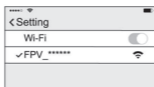

Connect WIFI

Photo/Video saving function

The videos and pictures will be saved to phone's App.

Flight

Surroundings Requirements of the Flight

1. Do not fly in bad weather, such as strong wind, snow, rain, fog, etc.
2. Choose an open place without tall buildings around to fly.
3. When flying, keep the aircraft in sight, stay away from obstacles, crowds, water, etc.
4. Do not fly in areas with high-voltage lines, communication base stations or transmission towers, avoiding interference with the transmitter.
5. When flying at the place whose altitude above 6000m, due to environmental factors, the performance of the aircraft battery and power system will decrease, and the flight performance will be affected correspondingly. Please fly with caution.
6. Recommend to fly the aircraft in door.

Flight restrictions and special area restrictions

According to the regulations of the International civil aviation organization and the air traffic control of various countries on airspace control and the regulations of the management of drones, drones must fly in the specified airspace.

Pre-Flight Inspection

1. Whether the transmitter, aircraft battery and phone are fully charged.
2. Whether the propellers are installed correctly.
3. Make sure the camera lens is clean.
4. Ensure to use official accessories or officially certified accessories. The non-official accessories may cause damage of the aircraft.

The Operation of Aircraft

Transmitter and aircraft signal matching

- Turn on the transmitter firstly, then the LED indicator lights flashing, the transmitter is in matching code situation.
- Install the battery into the aircraft, long press the aircraft's power switch, then the LED lights flashing, the aircraft is in matching code. Push the left joystick to the top, then pull to the bottom, when the transmitter have a long beep sound, and the LED lights in the transmitter&aircraft stay on, then the code has matched successfully.



When matching the signal, please make sure that no other transmitter or the aircraft are powered on nearby at the same time, otherwise the signal matching will have errors.

Gyro calibration

After matching code, place the aircraft on the flat ground, pull the left and right joysticks to bottom right in the same time (see below Pic). At this time, the LED lights of aircraft flash quickly, the gyroscope enters the calibration state. When the LED lights change from flashing quickly to stay on, then the calibration has completed, in the same time the transmitter will have a Beep sound.

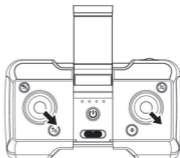
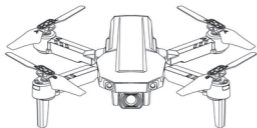

In gyro calibration, the aircraft should be place on horizontal ground, otherwise will affect the flight performance.

Aircraft unlocking/Locking method

Aircraft unlocking method:

Press the left joystick to bottom right corner and the right joystick to bottom left corner (as the right picture) for 1 second, then the blades of the aircraft rotate slowly.

Aircraft locking method:

When the aircraft landing on the ground, the blades are rotating, press the left joystick to bottom right corner and the right joystick to bottom left corner (as the right picture), the blades will stop rotating.

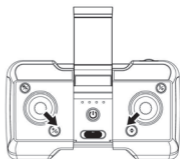

Operate the aircraft

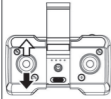
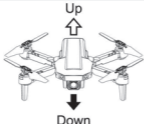
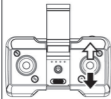
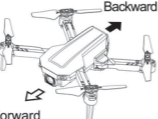
Transmitter	Aircraft
	 <p>Up</p> <p>Down</p>
	 <p>Forward</p> <p>Backward</p>

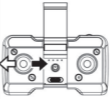
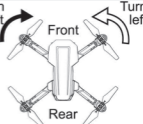
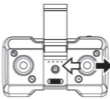
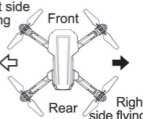
Transmitter	Aircraft
	 <p>Turn right</p> <p>Turn left</p> <p>Front</p> <p>Rear</p>
	 <p>Left side flying</p> <p>Right side flying</p> <p>Front</p> <p>Rear</p>

Basic Flight

The steps of basic flight

1. Place the aircraft on a flat and open ground with the user facing the rear of the aircraft.
2. Turn on the transmitter and the aircraft.
3. The transmitter and aircraft match code.
4. Open the M-DRONE App, connect the phone to V1, and enter into the camera interface.
5. Slowly push the throttle stick up, the aircraft take off smoothly, and control the aircraft with the left/right joystick
6. Pull down the throttle stick to lower the aircraft
7. After landing, pull the throttle to the lowest until the propellers stop rotating.
8. After stopping, turn off the aircraft and the transmitter in turns.

Photograph tips and skills

1. Do a pre-flight inspection.
2. Select the appropriate gimbal camera angle
3. Fly and take photo in a good weather without wind.
4. Do a test flight, helping to make a plan of route and find a place to take view.
5. Push the joystick as slow as possible during the flight, making the aircraft fly smoothly.



The flight safety is very important for you, the surrounding people and the environment. Please read the "User Guide" carefully.

Appendix

Packing List

The full package contains the following items.



Aircraft *1

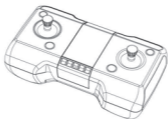

Transmitter *1



Propellers *2

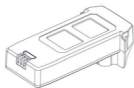

Aircraft Battery *1



USB Cable *1



Screwdriver *1



User Guide *1

Important Statement

- This product is not a toy, but a precision device that integrates professional knowledge of machinery, electronics, aerodynamics, and high-frequency emission. It requires proper installation and debugging to avoid accidents. The product holder must use a safe way to operate and control. Otherwise, it may cause serious personal injury or property damage.
- This product is suitable for people who have experience in operating model aircraft and at least 14 years old.
- If any problems with use, operation, maintenance, etc., please contact your local dealer or relevant personnel of our company. Our company and the seller are not responsible for any loss and damage caused by improper use or operation, as well as human injury.
- The product contains small parts, please keep it out of the reach of children to avoid the risk of ingestion or suffocation.

Safety Precautions

The remote control model aircraft is the most dangerous commodity, please keep it away from the crowd when flying. Improper assembly or damage to the aircraft body, poor electronic control, and unfamiliar operation may cause unpredictable accidents such as aircraft damage or personal injury. Operators must pay attention to flight safety and understand their responsibility for accidents caused by their own negligence.

● Stay away from obstacles and people

The remote control aircraft has an uncertain flight speed and state during flight, is potentially dangerous. When flying, please stay away from crowds, high-rise buildings, high-voltage power lines, etc., and avoid flying in bad weather such as wind, rain, and lightning. Debugging and installing the aircraft must strictly follow the operating instructions. Pay attention to keeping the aircraft at a distance of 1-2 meters away from the user or other people during flight, to avoid the aircraft from crashing into the head, face and body of the person when flying or landing, causing injury.

● Keep away from humid environment

The inside of the aircraft is composed of many precision electronic components and mechanical parts. Therefore, it is necessary to prevent the aircraft from getting wet or moisture into the body, avoiding accidents caused by mechanical and electronic component failure. Please wipe the surface stains with a clean cloth during maintenance.

● Practice flying together with skillful pilot

There is a certain degree of difficulty in the early learning of remote control aircraft control skills. It is necessary to avoid flying alone, be guided by an experienced person.

● Use this product properly

Please original parts for installation or maintenance to ensure flight safety. Operate and use within the scope permitted by the product function, and must not be used for other illegal purposes.

● Safe Operation

1. Please operate the remote control aircraft according to your own flying skills. Fatigue, poor spirits or improper operation will increase the probability of accident risk.
2. Do not use it near your ears! Misuse may cause hearing hurt.

● Keep away from high-speed rotating parts

When the aircraft propellers are rotating at high speed, please keep the pilot, surrounding people and objects away from the rotating parts to avoid danger and damage.

● Keep away from heat source

The remote control aircraft is composed of metal, fiber, plastic, electronic components and other materials. Therefore, it is necessary to keep away from heat sources, avoid deformation or even damage due to high temperature.

● Environmental protection requirements

Discard the product at will, which may affect the environment. Please recycle it properly according to local laws and regulations.

The toy shall be used with caution since skill is required in order to control the flight and avoid collisions with the user, objects or third parties;

Do not touch the rotating rotor, avoid loose clothing or hair that could be caught in the rotor, do not fly near the face;

keep the instructions for use.

Warranty Information

Our product is guaranteed to be free from manufacturing defects for a period of 12 Months.

If your product becomes defective during this period, Electus Distribution will repair, replace, or refund where a product is faulty; or not fit for intended purpose.

This warranty will not cover modified product; misuse or abuse of the product contrary to user instructions or packaging label; change of mind and normal wear and tear.

Our goods come with guarantees that cannot be excluded under the Australian Consumer Law. You are entitled to a replacement or refund for a major failure and for compensation for any other reasonably foreseeable loss or damage. You are also entitled to have the goods repaired or replaced if the goods fail to be of acceptable quality and failure does not amount to a major failure.

To claim warranty, please contact the place of purchase. You will need to show receipt or other proof of purchase. Additional information may be required to process your claim.

Any expenses relating to the return of your product to the store will normally have to be paid by you.

The benefits to the customer given by this warranty are in addition to other rights and remedies of the Australian Consumer Law in relation to the goods or services to which this warranty relates.

This warranty is provided by:

Electus Distribution

Address 46 Eastern Creek Drive, Eastern Creek NSW 2766

Ph. 1300 738 555



R-NZ



MADE IN CHINA