

Not suitable for children under 14 years old  
Please read through this manual before use

# ***1:10 SCALE HIGH SPEED R/C TRUGGY***



UP TO  
**50** KM/H



## Warning:

Choking hazard! This product contains small parts. NOT suitable for children under 14 years. Contains electrical components and should be kept dry at all times. Regularly check the battery charger wires, plugs and shell and other components for damage. DO NOT use if any part is damaged.



## Warning:

1. Detachable small parts should be stored safely and out of reach of children.
2. If interference is experienced, turn the model off and try it again in a different area.
3. Remote control will not function correctly if the batteries are low. Please replace the batteries.
4. Please discard old/used batteries in a safe manner. Consider your environment!
5. Please store the remote control in cool, dry place.
6. DO NOT expose to fire or high temperatures, moist storage.
7. Should the battery get wet, wipe immediately with a soft dry cloth.  
If transformed, please stop usage.
8. DO NOT touch the car while moving to avoid injury.

## Battery use caution proceeding

### Caution proceeding

1. The remote control car uses a set of Li-po 7.4V rechargeable batteries.
2. Remote control uses 4x 1.5V AA batteries.
3. Please pay attention to correct polarity when replacing batteries.
4. Rechargeable batteries should be charged under adult supervision.
5. DO NOT use a mix of old and new or different types of battery.
6. After the battery is exhausted, the model should be removed.
7. DO NOT short circuit any terminals.
8. DO NOT attempt to recharge non rechargeable batteries.
9. Remove batteries from the model when recharging.
10. DO NOT put batteries into a fire or into water.
11. The rated input voltage battery charger MUST be suitable for your mains power voltage.
12. During charging it is quite normal for the charger and batteries to heat up.

# SAFETY PRECAUTIONS

It is a radio control model, not a toy!

In order to enjoy running the car, you need to finish assembly before operation. Do routine maintenance work after operation.

Replacement parts and option parts are available separately.

Improper usage with Alkaline cells or rechargeable batteries may damage the electronics for the car or the radio.

**IN ORDER TO OPERATE THE CAR SAFELY, BE SURE THAT YOU HAVE OBSERVED THE FOLLOWING POINTS:**



Please follow the point as below in order to prevent accident from happening to the car and people.



- Be sure to read thoroughly the manual before you begin. Fresh user should seek advice from people having rich experience in order to assemble the model correctly.

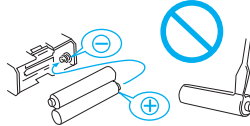

- Never reverse connection/disassemble the battery. This may lead to damage and leakage.



- As the product contains small and sharp parts, assemble and store this product only in places out of the reach of children.

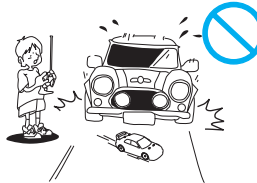

- Do not operate the model on public roads, in crowded places and near infant as it may cause accidents.



Please follow the following steps to operate, in order to prevent hurt to your body or damage of material property.



- Cutters, nippers and screwdrivers need careful handling.



- Painting must be done only in a well-ventilated area.

- When the model is not in use, always turn off the receiver and transmitter. Further more, disconnect the batteries and remove them from the model and the transmitter. This may be dangerous such as overheat and leakage.

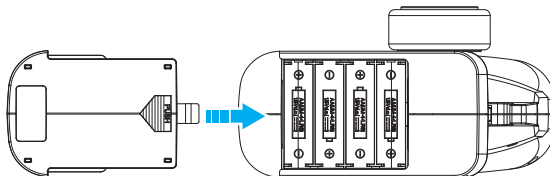



● Do not expose this model to high temperature, humidity or direct sunlight.

## OPERATING YOUR MODEL SAFELY



### WARNING!

Do NOT operate the model in the following places and situations. (Non-observance may lead to accident!)

● Operate your model in spacious areas ONLY with few people around! Do not operate it:

1. On road!
2. In places where children and many people gather!
3. In residential districts and parks!
4. Indoors and in limited space! Non-observance may result in personal injury and property damage!

● Always check the radio batteries!

With weak dry batteries, transmission and reception of the radio would fall off. You may lose control of your model in such condition. This may also cause serious accidents!

● Keep in mind that people around you may also operate a radio control mode!

NEVER share the same frequency with somebody else at the same time! Otherwise, Radio signals will be mixed up and you will lose control to your model. This may lead to accidents.

● The car must stop immediately and check for the reasons when it is operating abnormal.

As long as the problem is not cleared, do NOT operate it! This may lead to further trouble and unforeseen accidents!

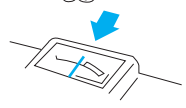

### WARNING!

In order to avoid accidents and personal injury, be sure that you have observe the following points:

● The safety of battery:

1. Exhaust battery should be safety dispose!
2. Non rechargeable batteries are not to be recharged, there is danger of explosion!
3. Do not throw the of battery into a fire! There is danger of explosion!
4. Do not swallow battery!
5. Store only in cool, dry and dark places and should be keep out of the children!
6. When the battery leaks the liquid and let it into your eyes, please right away rinse them and consult an ophthalmologist.

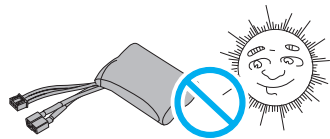

### PROHIBITED

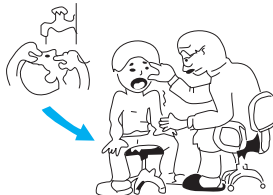

● Do NOT put fingers or any objects inside rotating and moving parts!

● Right after use, do NOT touch the motor! Danger of burning yourself.

## Box Contents

### Included the following parts

Body(To the actual product)

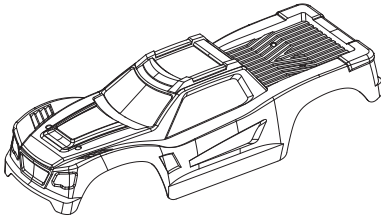

Chassis(To the actual product)

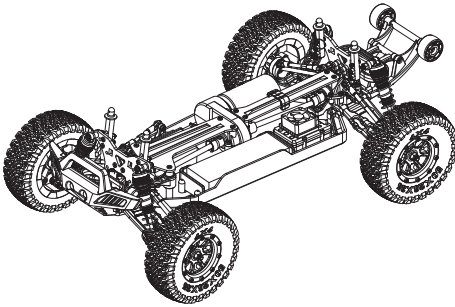

Transmitter

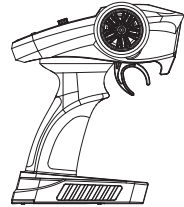

Large power  
Li-Po battery

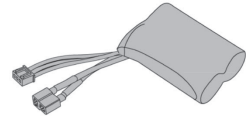

Charger



Cross Wrench(small)

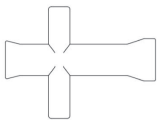

Screwdriver



Instruction  
manual

## About the Radio

- 1、 Instructions for pairing: turn on the power switch of the remote control. When the power indicator of the remote control flashes red and green, turn on the power switch of model car. At this time the returning-centering sound of server is audible and the indicator of the model car turns bright solid. Then the pairing is completed.

- 2、 Accept the machine plug schematic.

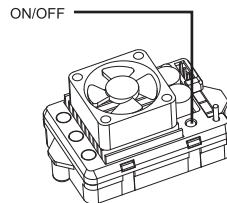

## Remote Control

Our company has been configured a new-style transmitter for model car. Please read the instruction manual carefully. The following is the transmitter's description of all functions.

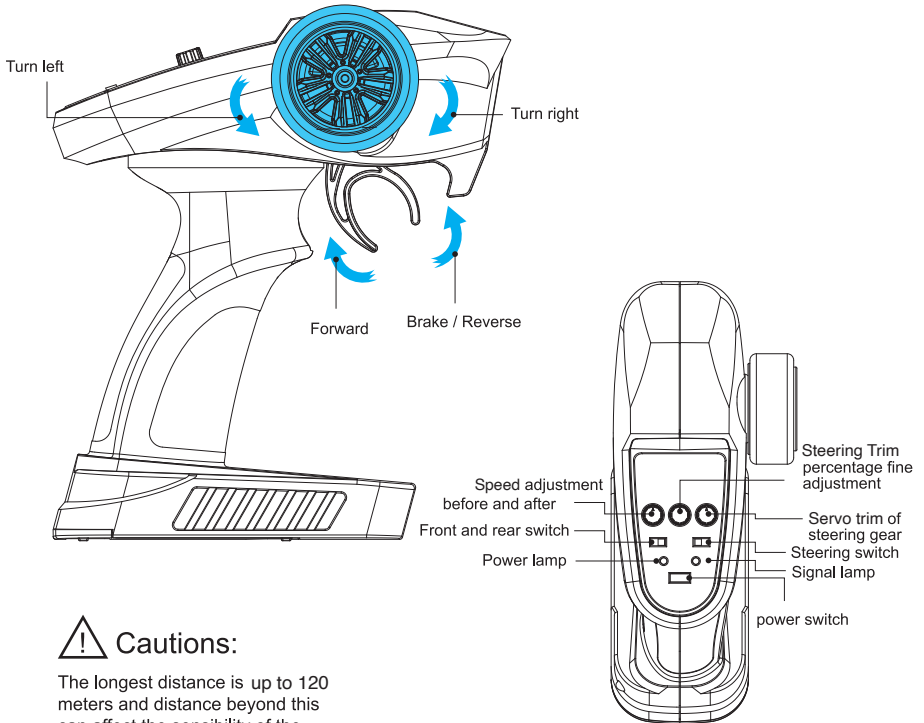

### Cautions:

The longest distance is up to 120 meters and distance beyond this can affect the sensibility of the operation.

## Assembly of the transmitter

1. Remove the battery lid.

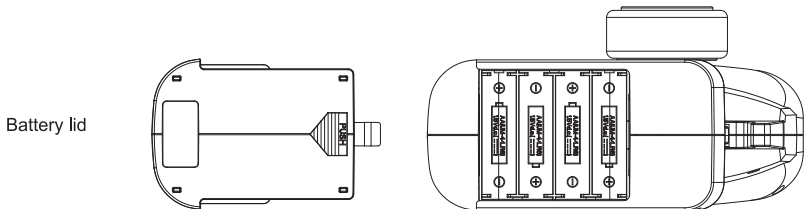

- ②、 Load 4 AA-size alkaline batteries as shown in the illustration. Caution: install batteries with correct polarity.

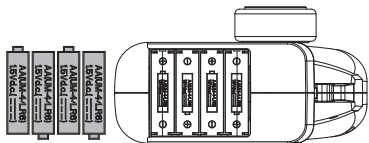

- ③、 Replace the lid as shown.

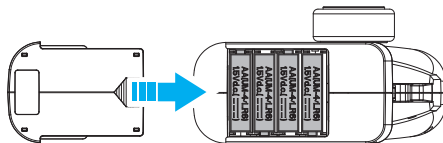

## Model battery's charging and assembly

- ①、 Charge

Plug the charger into the power socket as illustrated in the diagram and at this time the indicator of the charger is not on. Then connect the charger with the battery pack as illustrated; at this time the indicator turns red (in charge). After approx. 150 minutes when the charging is completed, unplug the charger. The battery pack lasts for approx. 10 minutes With full power.

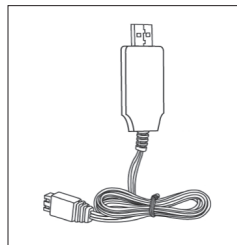

### ⚠ Cautions:

Charging must be operated under the guidance of adults.

- ②、 Remove the model lid, open the battery cover lid

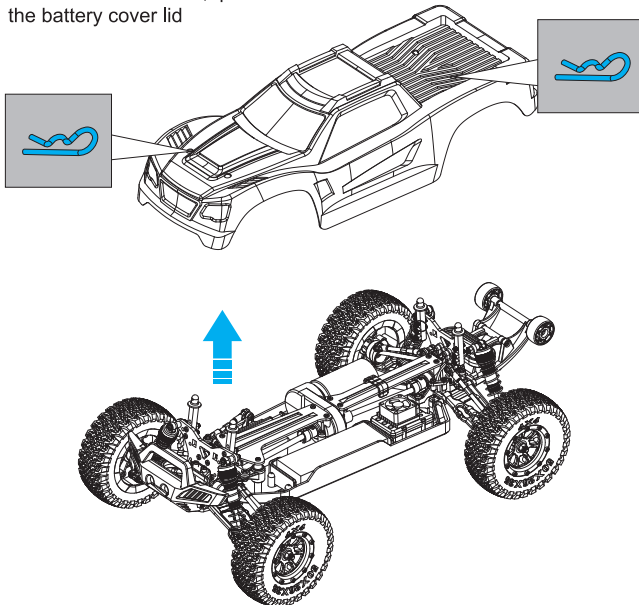

### ③、Installing battery

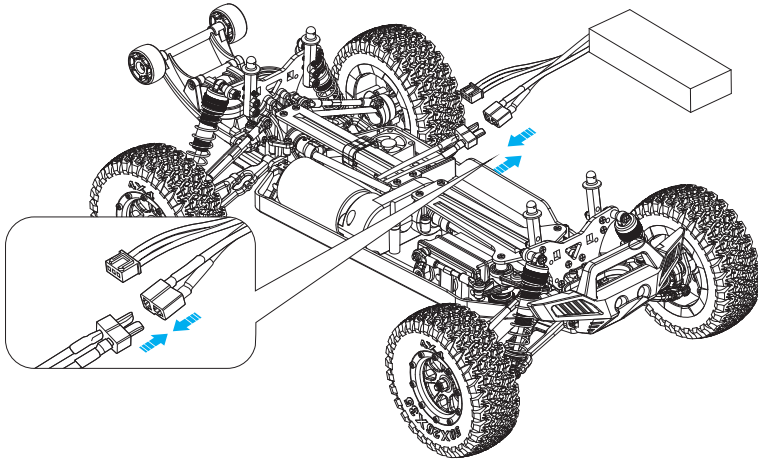

## Pre-Run Check

### ①、Chassis(Switch)

Turn on the power at the bottom of the car, the electric panel indicator will flash.

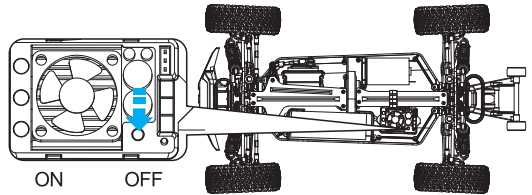

### ②、Transmitter(Switch)

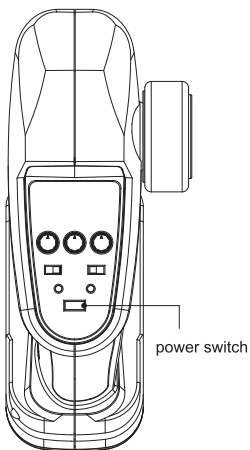

Red-green flashes indicate a state of pairing.  
Solid red and flashing green indicate shortage of power.  
Flashing red with no green indicate serious shortage of power. Please replace batteries immediately.

### ⚠ Cautions:

A new frequency bind is required after each on-off of the power switch.

Switch OFF the power switch of chassis and then switch OFF the power switch of the transmitter after playing.

Remove all batteries when it's not used for a long time.



③、 Check the Steering

Operate the steering wheel to check if the front tires move correctly.

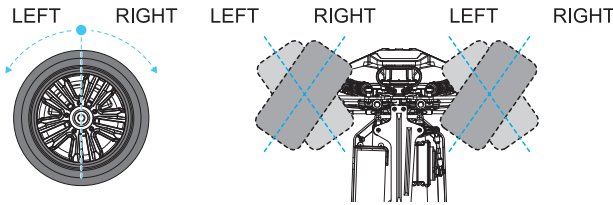

Amount of front tire movement varies according to the amount of the steering wheel movement. If the wheel is turned all the way left or right, the front tires will also steer all the way right or left.

④、 Turn trim

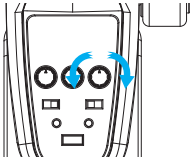

For adjusting the front tires left and right.

Precisely adjust the steering trim in case the front tires are not straight when the steering wheel is placed at neutral position.

Adjust again when running.

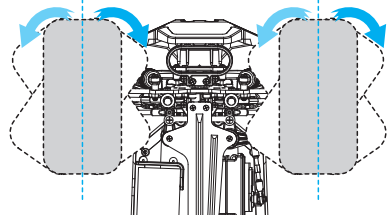

Keep the front tires in the air while adjusting the steering trim.

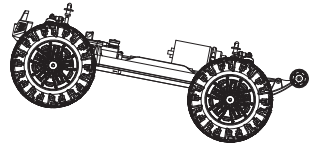

⑤、 Check Throttle

Push the controller trigger to backwards by finger, the car will forward; Push open the controller trigger to forward by finger, the car will brake and go backward. (Push open the controller trigger the first for the brake by finger, after loosening the hand and the trigger return to center, push open the second for backwards.)

The speed of the tire revolves is varied from the change of the L "middle" position, if the trigger pressed tightly backward, under this circumstances, the speed of tire revolves will reach highest.

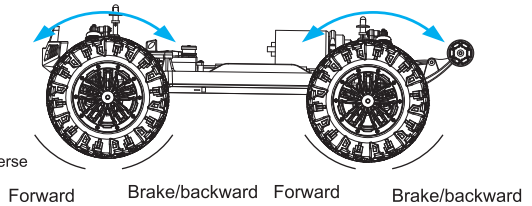
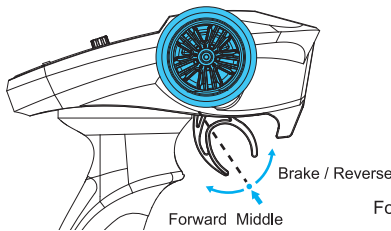

## Maintenance

Checking if all screws are loose or not.

Apply lubricating oil to all the moving parts.

Wipe off the dust and oil.

Take out the battery from the controller.

Remove the batteries on the battery seat when you do not use the car.

# Spare Parts List \*Only limited parts available separately.

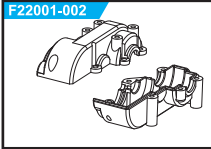

Medium wave case

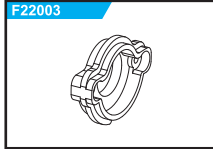

Motor base

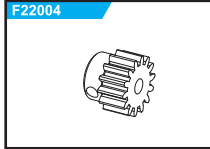

Motor gear

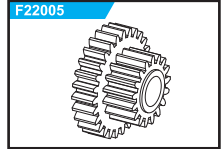

Secondary transmission gear

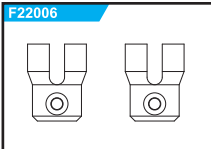

Cup head

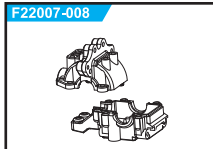

Front wave box shell

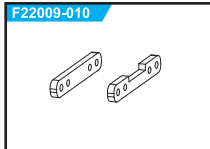

Swing arm fixing piece

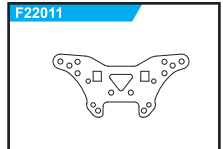

Damping seat

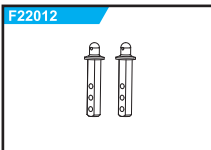

Shell support

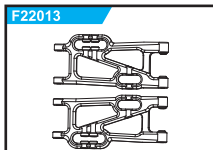

Swing arm

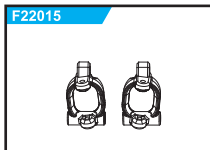

Front universal seat

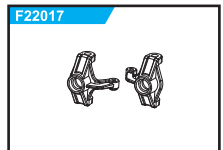

Front universal joint

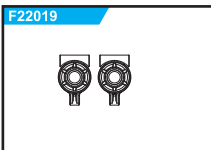

Rear universal seat

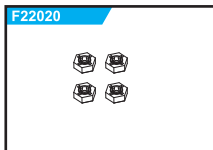

Hexagon sleeve

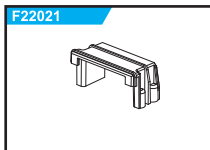

Steering gear seat

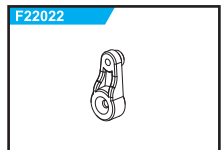

Steering gear swing arm

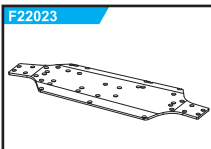

Underbody

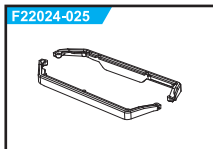

Underbody protection strip

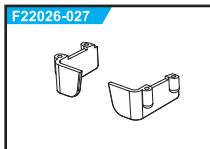

Battery holder

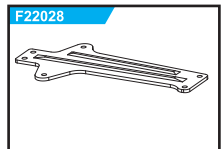

Front reinforcement

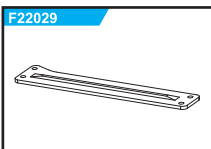

Rear reinforcement

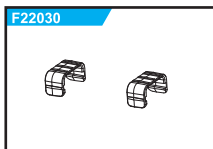

Cable holder

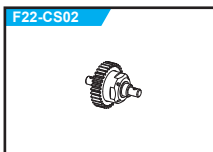

Middle differential



Front Differential

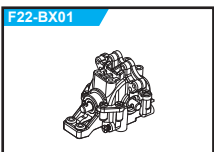

Front wave box

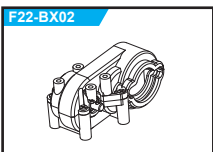

Medium wave box

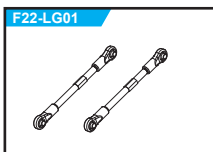

Swing arm connecting rod

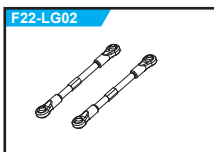

Steering link

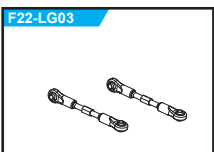

Steering linkage

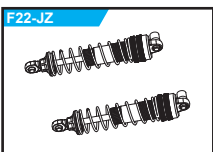

Shock absorber

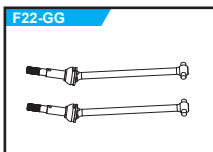

Dog bone

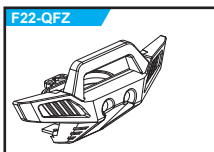

Front bumper

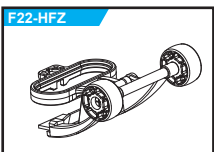

Rear guard

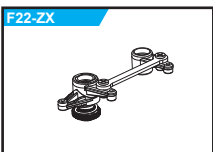

Steering assembly

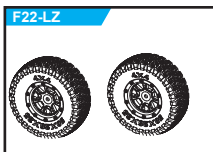

wheel

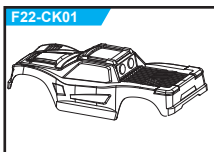

Car shell

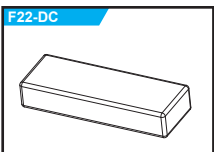

Battery

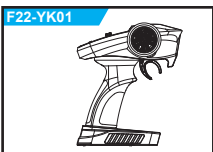

Transmitter

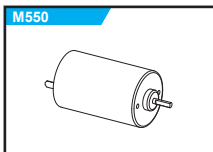

M550 motor

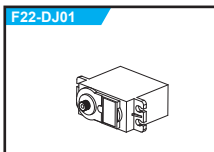

steering engine

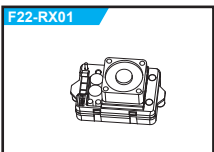

receiver



Charger

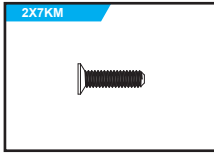

Screw

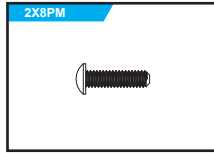

Screw

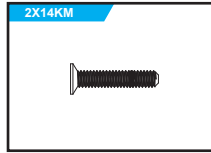

Screw

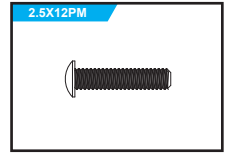

Screw

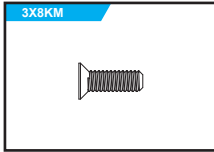

Screw

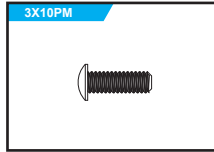

Screw

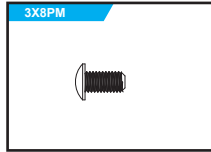

Screw

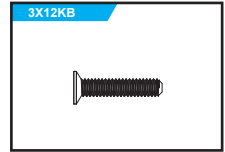

Screw

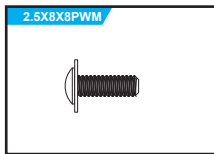

Screw

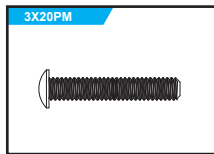

Screw

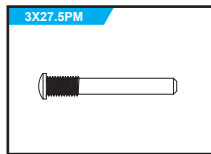

Screw

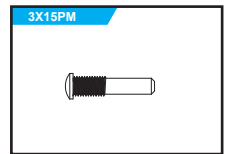

Screw

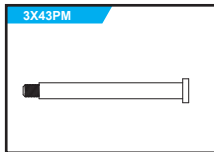

Screw

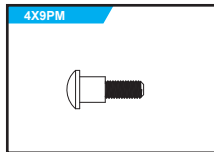

Screw

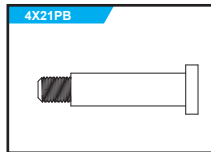

Screw

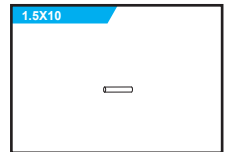

1.5X10 Steel pipe

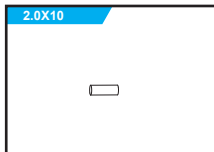

2.0X10 Steel pipe

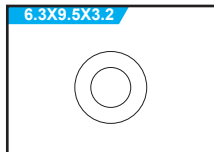

6.3X9.5X3.2 Bearing

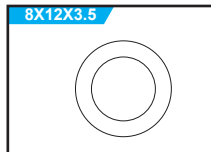

8X12X3.5 Bearing

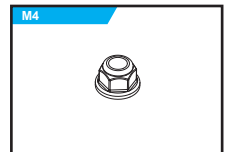

M4

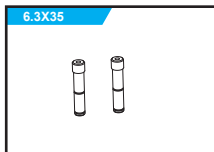

6.3X35 Bearing

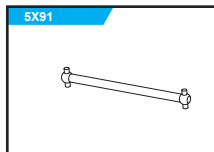

5X91 Bearing

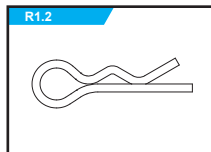

R-shape lock catch

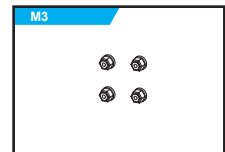

M3

## **Specifications**

- Speed: Up to 50km/h
- Frequency: 2.4GHz
- Remote Control Range: 120m
- Play Time: Up to 20 Minutes
- Charging Time: Up to 7 Hours
- Batteries:
  - Car: 7.4V Li-po, 5000mA (Included)
  - Remote: 4 x AA (Not Included)
- Dimensions: 435 (L) x 280 (W) x 170 (H) mm

Distributed by:  
Electus Distribution Pty Ltd  
46 Eastern Creek Dr,  
Eastern Creek NSW 2766 Australia  
Ph 1300 738 555  
Int'l +61 2 8832 3200  
Fax 1300 738 500

[www.electusdistribution.com.au](http://www.electusdistribution.com.au)