

R/C BLUE WHALE

User Manual

GT4310

8+
FOR AGES



Safety & Warnings:

1. Contains small parts! Not suitable for children under 8 years old. The Blue Whale contains tiny parts that could be dangerous if swallowed. Keep out of reach of children.
2. Only use in fresh water fish tanks, baths, pools or small ponds. Salt water may damage the blue whale.
3. Blue Whale is not suitable for outdoor use.
4. Do not use it in salt water, chemical water or contaminated water.
5. Do not use in large areas of water, such as oceans, rivers, lakes, canals, swimming pools or unknown depths of water.
6. Use alkaline batteries.
7. Keep away from heat.
8. Take care of your environment -- dispose of used batteries responsibly and recycle them as much as possible.
9. Blue Whale is only suitable for children 8 years old or older.
10. Blue Whale and related components are made of precision electronic parts. Please handle with care to avoid falling, pounding or disassembling

Antenna & Battery Installation:

1. Open the battery cover on the back of the remote control using a screwdriver.
 2. Install 3 x AA batteries using the correct polarity in to the battery computer.
 3. Place the cover back on the remote control and tighten the screws securely in place.
 4. Place the antenna into the antenna hole located at the top of the remote control.
 5. Gently turn the antenna in a clockwise direction until it's tightened.
- Note: Be careful not to over tighten the antenna when installing.

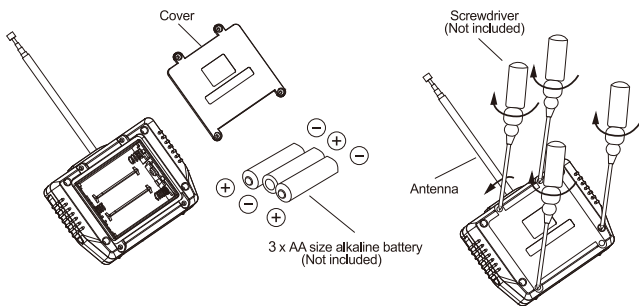

Charging:

1. Plug the USB charging cable to a USB socket of a USB mains power adaptor or computers USB port.
 2. Connect the USB charging cable's plug to the socket of the whale located on the bottom.
 3. The LED light will display when charging and turn off once the whale has fully charged.
- Note: The charging time will take up to 30 minutes.

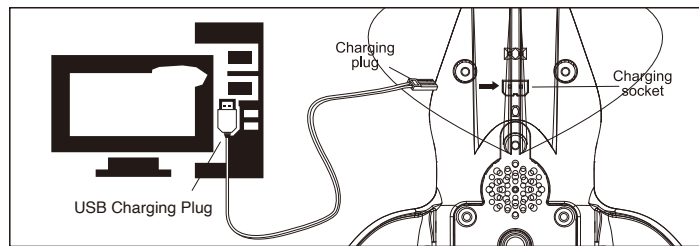

Note: Ensure the drain plug is completely plugged in before the whale is placed in the water.

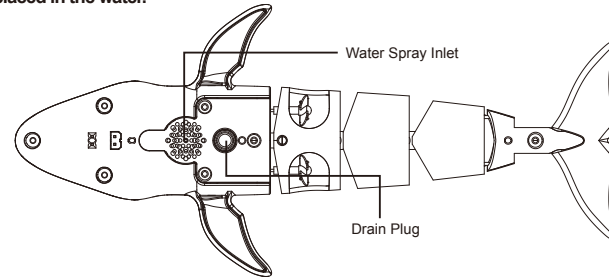

Operation:

1. Once the batteries have been inserted into the remote control and the antenna has been connected; Turn on the remote control.
 2. Place the blue whale head first in the water.
- Note: The water connecting points are located on the bottom of the whale; the whale will only operate once in water.
3. Pressing forwards on the remote control will make the blue whale go forwards and spray water. Press both forwards and one of the steering buttons for up to 3 seconds will make the whale dive.
 4. Pressing the backwards button will make the whale go back and still continue to spray water.
 5. Press the demo mode on button which will start operating automatically.
 6. Press the demo mode off button to stop the demo mode.
 7. Press the left or right steering buttons to make the whale turn left or right.

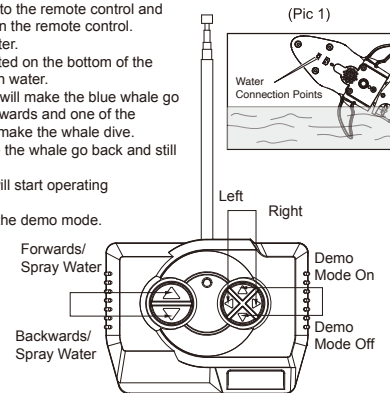
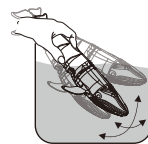

Note: The screws must be tightened when using the remote control

Draining The Whale:

Remove the whale from the water and pull out the drain plug and remove the excess water.

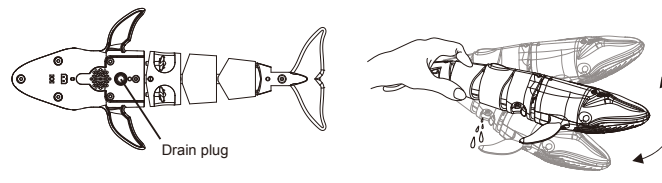

Troubleshooting

1. If the blue whale does not spray water or the amount coming out is extremely low; make sure the water spray hole and inlet is free from debris.
2. If the whale won't dive in the water; shake the body of the whale and submerge in water to eliminate excess air.

Note: The battery may need to be fully charged if the dive function is still not working.

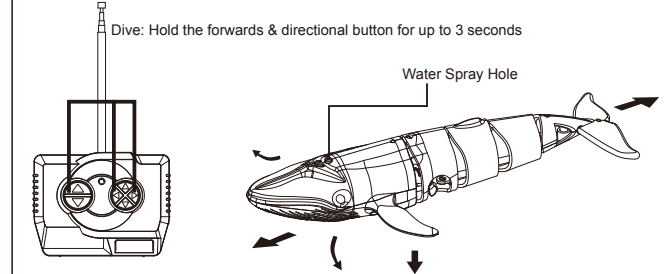

4. If the blue whale can't operate correctly; it may be caused by interference with the 27/40MHz frequencies. Try to move to another area or alternatively make sure the batteries in the remote control are 100%
5. If the blue whales playing time is lower than expected; it may take up between 5-8 charging and discharging cycles to restore the full operating time.

Battery Safety & Warnings

- The product itself uses 3.7V rechargeable lithium battery;
- The remote uses three 1.5V "AA" batteries;
- Pay attention to polarity when installing or replacing batteries;
- Non-rechargeable batteries are not rechargeable;
- Adult supervision is required when charging rechargeable batteries;
- Do not use old and new batteries, or different types, together;
- Electronic terminals should not be short-circuited.
- When the speed of the product slows down, it indicates that the product needs charging.
- Please charge the product according to the above method.
- If the battery of the remote control is insufficient and the power indicator becomes dark or not bright, replace the battery.
- Please check the charging plug and charging interface when charging.
- If it is not used for a long time, please take out the battery in the remote control and open the waterproof safety helmet of the product.
- Unpacking should be done under adult supervision.

Warranty Information

Our product is guaranteed to be free from manufacturing defects for a period of 12 Months.

If your product becomes defective during this period, Electus Distribution will repair, replace, or refund where a product is faulty; or not fit for intended purpose.

This warranty will not cover modified product; misuse or abuse of the product contrary to user instructions or packaging label; change of mind and normal wear and tear.

Our goods come with guarantees that cannot be excluded under the Australian Consumer Law. You are entitled to a replacement or refund for a major failure and for compensation for any other reasonably foreseeable loss or damage. You are also entitled to have the goods repaired or replaced if the goods fail to be of acceptable quality and failure does not amount to a major failure.

To claim warranty, please contact the place of purchase. You will need to show receipt or other proof of purchase. Additional information may be required to process your claim.

Any expenses relating to the return of your product to the store will normally have to be paid by you.

The benefits to the customer given by this warranty are in addition to other rights and remedies of the Australian Consumer Law in relation to the goods or services to which this warranty relates.

This warranty is provided by:
Electus Distribution
Address 46 Eastern Creek Drive, Eastern Creek NSW 2766
Ph. 1300 738 555