

FIGHTING ROBOTS

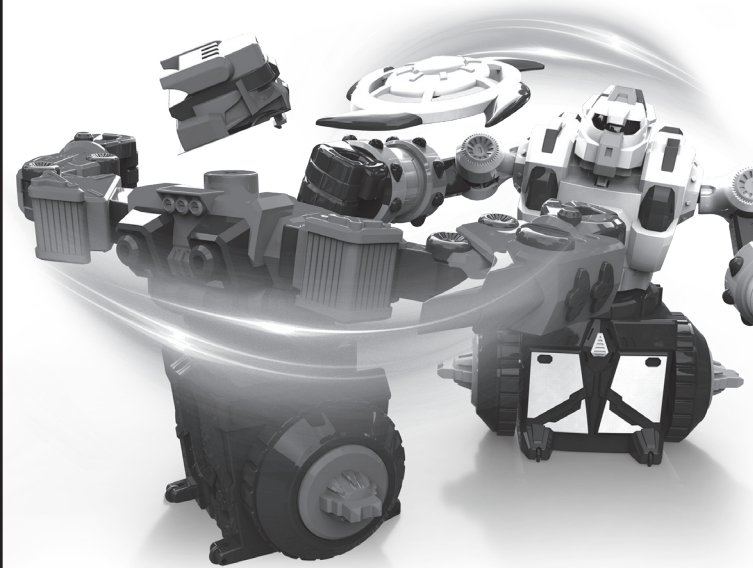

USER MANUAL

PRODUCT CONFIGURATION

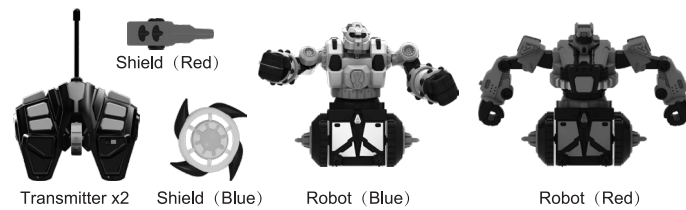

(Upper body clockwise rotation)

TRANSMITTER

TRANSMITTER FUNCTIONS

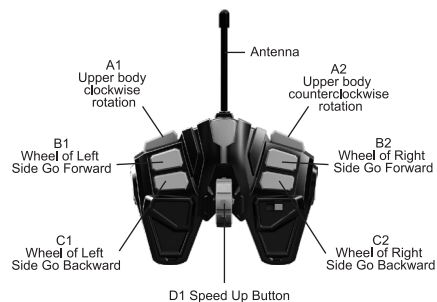

- Key of Function description
1. Make the defiant voice combination key: (C1+A1+B2/C2+A2+B1).
 2. Press B1+B2: go straight forward.
 3. Press C1+C2: go straight backward.
 4. A1: upper body clockwise rotation.
 5. A2: The right side wheel go forward, the robot counterclockwise rotation.
 6. B1: The right side wheel go forward, the robot clockwise rotation.
 7. B2: The left side wheel go forward, the robot clockwise rotation.
 8. C1: The left side wheel go backward, the robot counterclockwise rotation.
 9. C2: The right side wheel go backward, the robot counterclockwise rotation.
 10. D1: rotation Speed up.
 11. Press B1+C2: clockwise rotation.
 12. Press B2+C1: counterclockwise rotation.

TRANSMITTER BATTERY INSTALLATION

- (1) 2*1.5V AA battery for transmitter (not included).
- (2) Remove the screw on the battery box by screw driver.
- (3) Put 2X1.5V AA non-rechargeable battery into the battery box. (Notice: Batteries must be inserted with the correct polarity)
- (4) Put on the battery cover, lock with a screw.

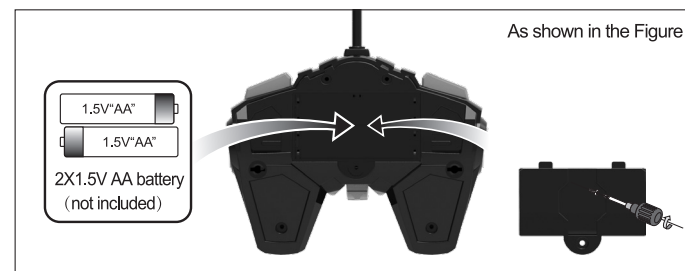

NOTES OF BATTERY USAGE :

- (1) Please use only the same battery or battery as recommended.
- (2) Don't mix different types of batteries or used and new batteries.
- (3) The battery should be put in the correct polarity.
- (4) Please remove the exhausted battery from the toy.
- (5) The power supply terminals shall not be short circuited.

BATTERY INSTALLATION

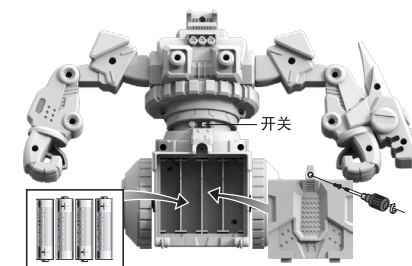

- Warning**
- Notice: Batteries must be inserted with the correct polarity.
 - Do not mix different types of batteries or used and new batteries.
- (1) 4*1.5V AA non-rechargeable battery for robot.
 - (2) Remove the screw on the battery box by screw driver.
 - (3) Put 4*1.5V AA non-rechargeable battery into the battery box. (Notice: Batteries must be inserted with the correct polarity)
 - (4) Put on the battery cover, lock with a screw.

- (1) When the transmitter is turned on, the red light is on.
- (2) Turn on the robot and transmitter, it will takes 5-6 seconds for binding.

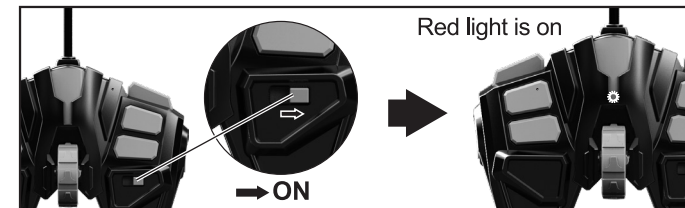

When the product bind successfully, the robot's eyes will blink and rotate left and right.

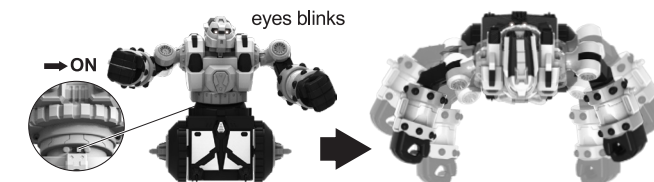

OPERATING PROCEDURES

TRANSMITTER OPERATION

- (1) As shown in picture 1, Press the B1(Left forward) button on the transmitter, the left wheel of robot will clockwise rotation.
- (2) As shown in picture 2, press the B2(Right forward) button on the transmitter, the right wheel of robot will counterclockwise rotation.

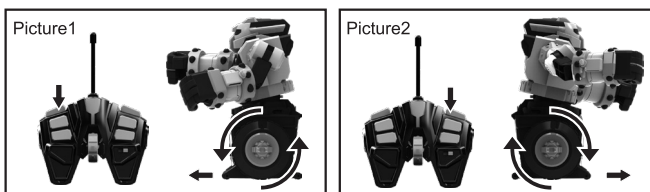

- (3) As shown in picture 3, press the C1 (left Backward) button on the transmitter, the left wheel of robot will counterclockwise rotation.
- (4) As shown in picture 4, press the C2 (right Backward) button on the transmitter, the right wheel of robot will clockwise rotation.

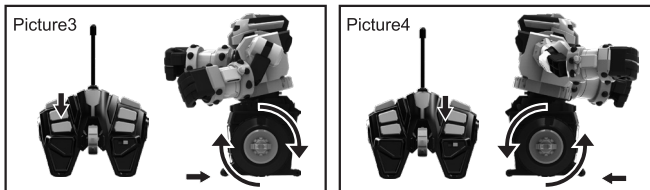

- (5) As shown in picture 5, press the A1 button, the upper body of the robot rotates counterclockwise.
- (6) As shown in picture 6, press the A2 button, the upper body of the robot rotates clockwise.

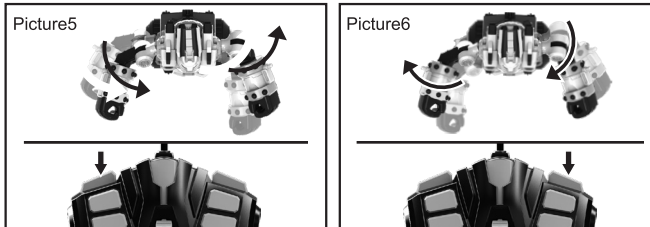

- (7) As shown in picture 7: press the B1 and B2 button at the same time on the transmitter, robot will go straight forward.
- (8) As shown in picture 8: press the C1 and C2 button at the same time on the transmitter, robot will go straight backward.

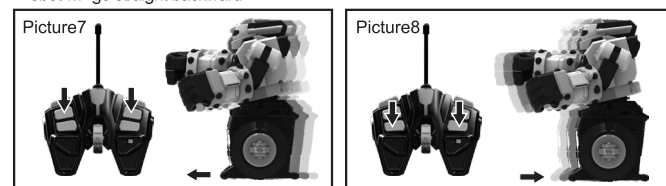

- (9) As shown in picture 9, press the C1+ A1 + B2 button at the same time on the transmitter, the upper body of robot will clockwise rotation and the lower body will counterclockwise rotation, it will swing with a provocative voice.
- (10) As shown in picture 10, press the C2 + A2+ B1 button at the same time on the transmitter, the upper body of robot will counterclockwise rotation and the lower body will clockwise rotation, it will swing with a provocative voice.

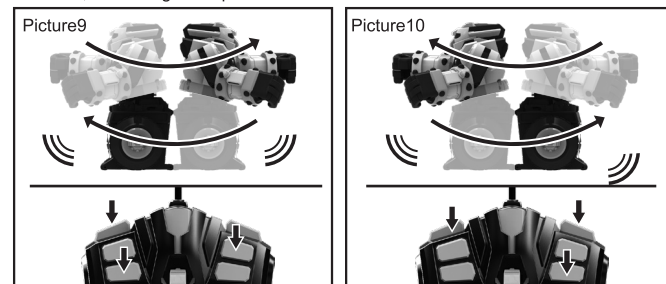

- (11) As shown in picture 11, press B1+C2 button at the same time, robot will rotation clockwise.
- (12) As shown in picture 12, press B2 (right forward) and C1 (left backward) button at the same time, robot will rotation counterclockwise.

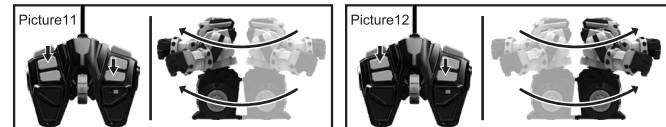

Remarks: When the robot rotates, you can quickly turn the accelerator button(D1), to accelerate the rotation speed, so that the rotation of the collection of more spin energy, in order to improve combat effectiveness.

- (13) As shown in picture 13: press the A1 and D1 button at the same time, robot will counterclockwise accelerated rotation.
- (14) As shown in picture 14: press the A2 and D1 button at the same time, robot will clockwise accelerated rotation.

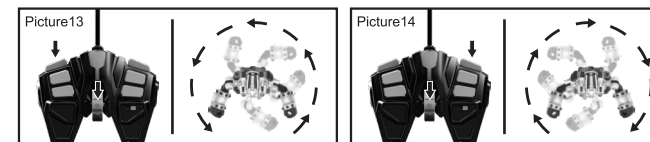

FEATURE

- (1) Simulation battle sound renders the fighting atmosphere. The robot is equipped with the appropriate combat weapons, can be freely removed, increase the defense, makes the battle more funny. (as like Picture 1 & Picture 2)

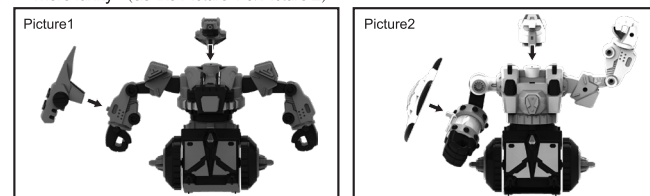

- (2) With a stable and solid 360 degree rotation of the waist design, when it is rotating, you can quickly turn the rotation accelerator to accelerate the speed of rotation, so that the rotation will collect more rotating power, in order to improve the combat effectiveness.

- (3) During the battle, as long as one robot hit the other one on the chest button, then that one's head will automatically pop, the robot will lose vitality, reactivate it need to reload the head of the robot (as like picture 3)

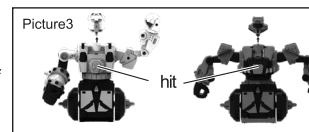

- (4) Turn on the robot and transmitter, and press the button of B1(left forward)+C2(right backward)+A2(right rotation) at the same time, (if Press the reverse button, the function is same), then the robot will swing and make defiant voice, increasing the fun of playing. (as like shown on page 7: Picture9 &10)

- (5) When this product is in a state of power on, there is a reminder of the sound function, every 5 minutes to remind once.
- (6) The robot itself uses 2.4GHz, the work frequency is stable, play diversification, domineering cool shape, much loved by the children.

Warning: (1).This product contains small parts, do not swallow to avoid suffocation risk, not suitable for children under three years old.(2).This product contains electrical components, shall not be used in water or in wet environment. Toys can not be connected to more than the recommended number of power supply.(3).Do not let the robot fall from the table and so on, to avoid damage. The packaging and instructions contain important information and should be retained.

BATTERY SAFETY INFORMATION

In exceptional circumstances batteries may fluids that can cause a chemical burn injury or ruin your toy(product).To avoid battery leakage:

- Non-rechargeable batteries are not to be recharged.
- Do not mix alkaline, standard (carbon-zinc), or rechargeable (nickel-cadmium) batteries.
- Do not mix old and new batteries.
- Only batteries of the same or equivalent type as recommended are to be used.
- Batteries are to be inserted with the correct polarity.
- Exhausted batteries are to be removed from the product.
- The supply terminals are not to be short-circuited.
- Dispose of battery (ies) safely.
- Do not dispose of this product in a fire. The batteries inside may explode or leak.

Warning! Not suitable for children under 36 months. Choking hazard. We recommend that you retain this packing for future reference.



Distributed by:
Electus Distribution Pty. Ltd.
46 Eastern Creek Dr,
Eastern Creek NSW 2766 Australia
Ph: 1300 738 555
Int'l: +61 2 8832 3200

Fax: 1300 738 500

www.electusdistribution.com.au