

Wi-Fi FPV R/C Drone with 1080P Camera User Manual

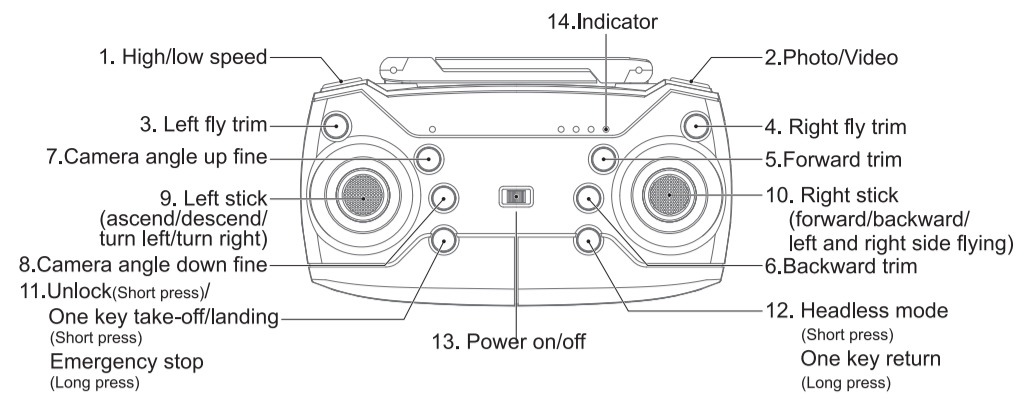

Thank you for purchasing our products. In order to use them properly and ensure your safety, please read this instruction manual carefully before using the products, and please keep them in a safe place for future reference.

1.REMOTE CONTROL FUNCTION KEYS & NAME DESCRIPTION



2.REMOTE CONTROL BATTERY INSTALLATION

2.1 Remove the battery cover from the back of controller (Fig. A)
 2.2 Install 3 "AA" batteries into the controller, make sure to install batteries to their correct polarity, (Fig. B)
 Do not mix old and new batteries or battery types.
 2.3 Replace the battery cover

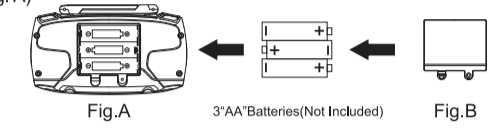

3.DRONE LITHIUM BATTERY CHARGING INSTRUCTIONS

3.1 Press the drone's rear battery module and pull the lithium battery module out of the drone battery compartment.(Fig.C)
 3.2 Plug the USB charging cable into the USB power socket, and then connect the other end to the charging socket of the lithium battery module. When charging, the LED light is always on. When the charging is finished, the LED light is off, and the charging time is up to 150 minutes.(Fig.D)
 3.3 After charging is complete, insert the lithium battery module into the battery slot as shown below.(Fig.E)
Special note: Please fully charge the battery before flying.
Low-pressure warning tips: When the drone enters the low-pressure alarm, the body light will flash slowly. At this time, it indicates that the drone has been exhausted and needs to fly back immediately.

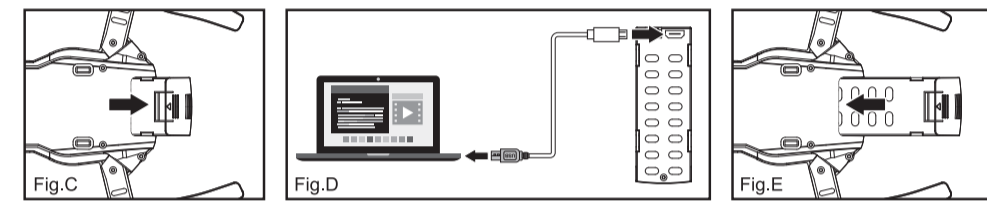

Attention:

- 1.Make sure the voltage of the USB charger fits the local electricity supply.(Keep the battery in a cool place to avoid exposure)
- 2.The Charging plug will overheat if overcharged. Please stop charging immediately as it may cause damage to the battery.
- 3.Do not leave the battery aside when charging.
- 4.Do not use other chargers other than the one supplied in consideration of safety.
- 5.Recharge the battery 30 minutes later after flying, because the battery temperature could be too high when flying and charging immediately could damage the battery.
(The drone needs to take out the battery when not in use and store it at 80% to extend battery life)
- 6.Do not leave the battery in the fire in consideration of safety.
- 7.Do not short circuit the battery. Do not leave the battery together with tiny metal parts in consideration of safety.

4.PRE-FLIGHT ENVIRONMENTAL REQUIREMENTS

Please choose an outdoor environment with no rain or snow, wind less than level 4. Please stay away from people, trees, power lines, tall buildings, airports and signal towers.
Special Tips: The flight time is up to 10 minutes, and the flight distance is up to 60 metres.

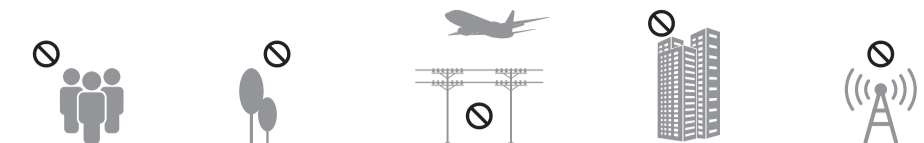

5.PREPARATION BEFORE FLIGHT

5.1 Drone frequency

1. Install the battery of the drone and the remote control battery, turn on the drone power switch, and the body lights up and then put it on the level ground.
 2. Turn on the remote control power switch, push the remote control throttle lever up and down, the body light becomes steady, and the remote control frequency is successful.
Important note: The product must be operated in steps, otherwise it is easy to connect and control poorly.

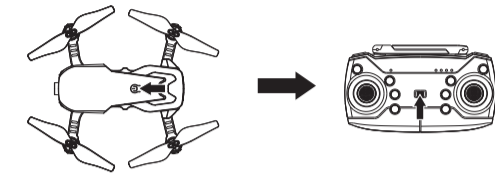

5.2 Calibration of gyroscope operation

After the drone and the remote control have successfully matched the frequency, the drone can be corrected, and the throttle lever and the direction control lever are simultaneously hit to the lower right corner. At this time, the indicator light of the drone flashes rapidly, and the indicator light is always on, and all the buttons of the remote controller are released. The calibration is complete.
Special Tips: If the drone takes off and flies, it can also be corrected by correcting the gyroscope.

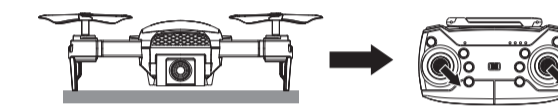

Note: Correction should be done at the horizontal level.

5.3 Drone unlock

Under the operation of the remote controller, the drone needs to unlock, press the remote control unlock button (Fig.1), or push the remote control throttle lever up to the highest position (Fig.2). At this time, the four propellers are at the same time. Speed rotation indicates successful unlocking. When unlocking is completed, the drone can operate normally.



5.4 One key take off and landing

When the unlocking is completed, press the function button of the remote control (Fig. 3) again, the drone will automatically rise to a height of about 1 meter to keep the altitude flying smoothly; when the button is used for the takeoff/landing icon, the drone will automatically land slowly.
Note: One key landing must land on a horizontal plane, because a fixed-height function landing on a horizontal surface will cause the drone to fly and fly.

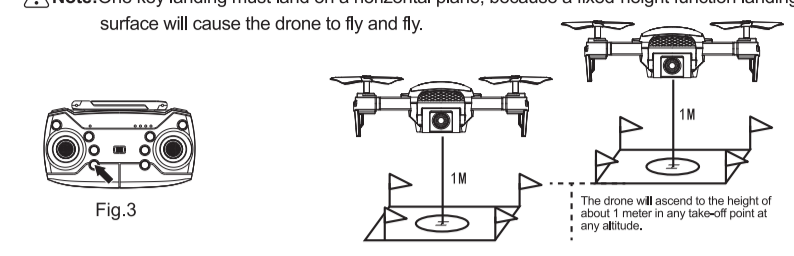

Flight step prompt: frequency(5.1) → gyroscope correction(5.2) → Unlock(5.3) → one key take off/one key landing(5.4)

6.CONTROL METHOD

Enter the main interface, select the flight mode, you can see the interface of the drone operating joystick, the operation is as follows:

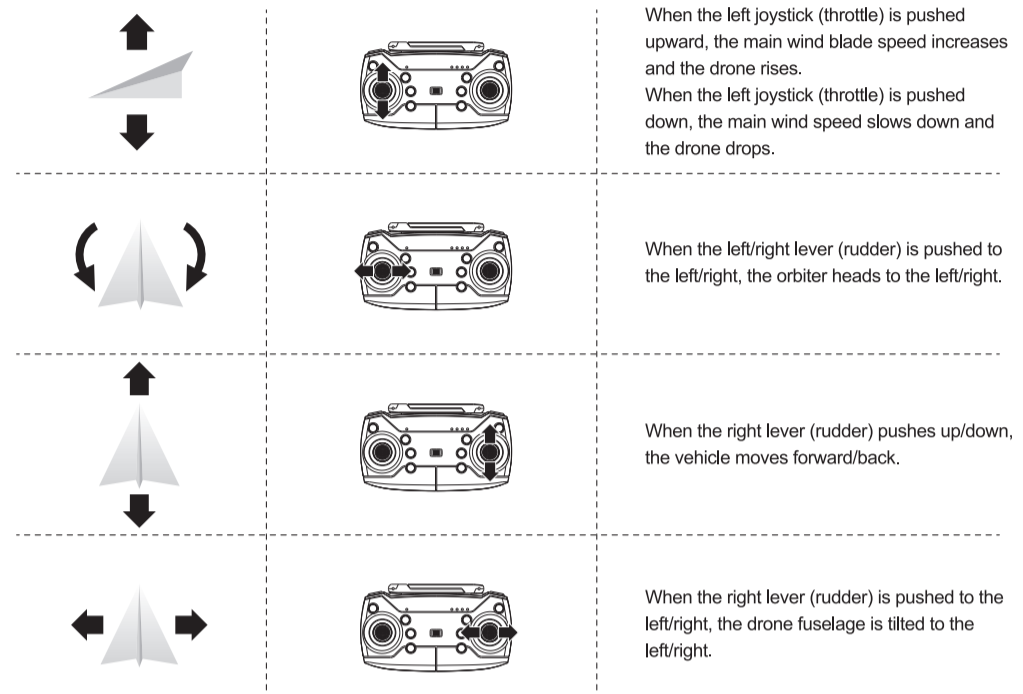

WARNING: When the drone is located 30CM above the ground, The Drone is not stable due to the influence of the eddy current, which is called "ground effect reaction", and the height more lower the drone is, the greater the impact of the effect will be.

7. SPEED SWITCHING

Speed switching: "Di-" is the low speed mode, "Di-Di-" is the medium speed mode, and "Di-Di-Di-" is the high speed mode. (power on default low speed mode)

8. TRIMMING FUNCTION

If the drone does not push the rudder lever during flight and is still spinning or flying in the air, you can use the fine adjustment function to adjust the rudder. The operation is as follows:

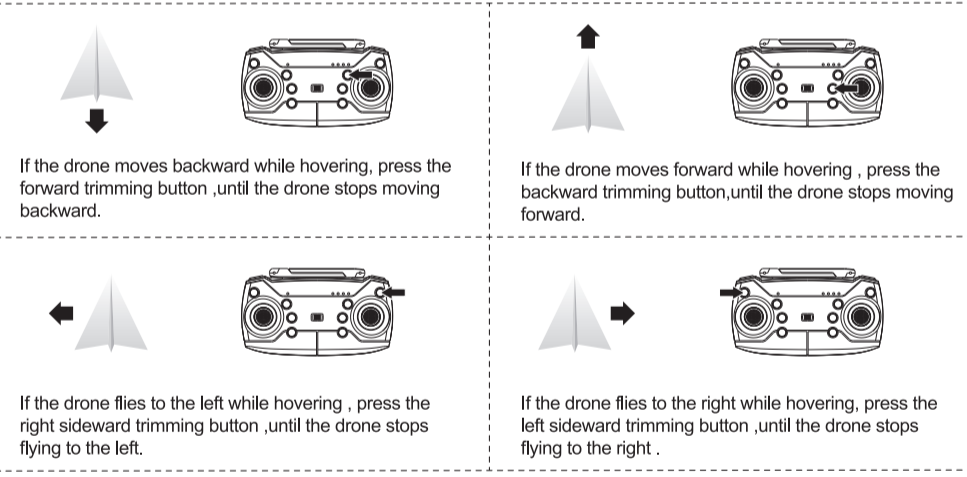

9.HEADLESS MODE

9.1 Startup and setup
 In front of the drone when the power is turned on, the default is the front of the headless mode; if the impact or the front of the flight is biased, please restart the drone and adjust to the direction you need to perform the frequency; after the frequency is successful, the machine The head direction is the front of the headless mode. When the headless mode button is pressed, the drone body light flashes and enters the headless mode.
9.2 Exit headless mode
 Press the headless mode button again (the remote control emits a "Di-"), the body light turns on constantly, and the headless mode is exited.

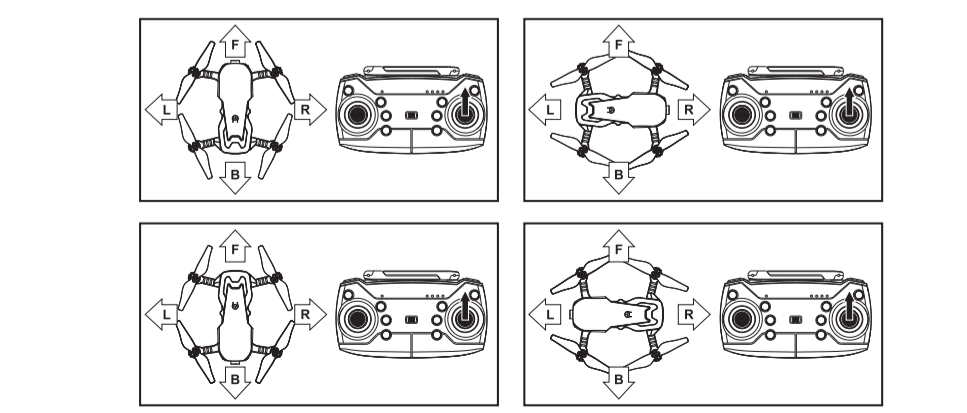
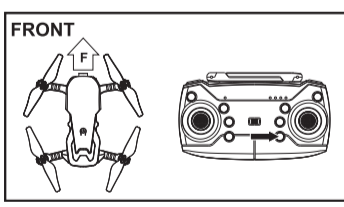

As shown in the above figure, in the headless mode state, no matter which direction the drone head is turned, the remote control direction lever is pushed forward, and when the drone is turned on, the head moves in the direction of the head.

10.ONE KEY RETURN

When the drone is flying farther away, the drone can be recalled using the return function. During the flight, long press the home button for 3 seconds to start the Return(Fig.4). After starting the home, the drone to the start of the frequency of the end of the other side to return, the return process, the right joystick before and after the action or long press the home key 3 seconds, cancel the Return.

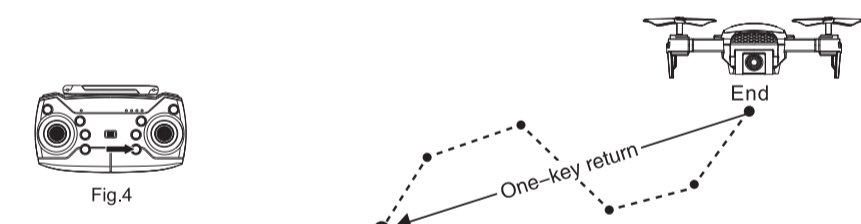

11.ONE KEY EMERGENCY

When the drone collides during flight and cannot be controlled, the emergency stop function button can be used to realize the emergency stop. Press and hold the emergency stop button for 3 seconds (Figure 5).The operation is as follows:

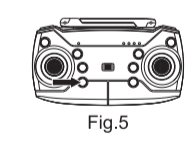

12.CAMERA ANGLE FINE-TUNING

The drone is equipped with a 5-speed adjustable camera. When the camera is at the center of the first gear, tap the angle down to adjust the camera (Fig.6). If you need to adjust the upward direction, tap the angle to fine-tune. The button (Fig.7) allows you to adjust the camera up one step.

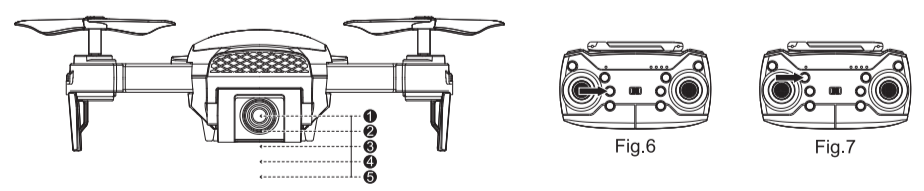

13.MAIN BLADE INSTALLATION :

The position of the blade of the drone is installed. Please install it according to the corresponding code. The code is as follows:



14.COMMON PROBLEM SOLVING GUIDELINES

Problems	Reasons	Solutions
No response to the drone indicator flicker	1.The drone and the remote are not successful 2.Low power	1.Re-frequency the drone and remote control(5.1) 2.Charge the battery(3)
The drone blades turn but can't fly	1.Insufficient battery power 2.Blade deformation	1.Charge the battery(3) 2.Replace blade(13)
The drone vibrates badly	Blade deformation	Replace blade(13)
Tweaked to the end but still can't smooth the drone	1.Blade deformation 2.Poor motor	1.Replace blade(13) 2.Replace the motor
The drone was launched again after the crash, but not stable	The sensor is out of balance because of the crash	After the drone is placed for 5-10 seconds, or by correcting the gyroscope, it will be fine(5.2)
One motor does not turn	Motor stuck	1. Clean up foreign objects rolled up by the blades 2. Gently dial the blade upwards, restart and correct the gyroscope and take off (5.2)

Special note: The product has a function of air pressure and height, but it does not have a fixed point effect. When it is not controlled in the air, the product will move slightly at the same height in the air.

15.NOTES

- 15.1 Please ensure that the battery power is sufficient and the remote distance will be affected when the battery is low.
- 15.2 If the batter power is not enough, it will not fly high enough or take off
- 15.3 If the drones are broken and deformed, please repair them in time. If the rotors are broken and damaged, they will not fly, or they will cause injury
- 15.4 Please avoid crash or a serious collision, which can damage the drone or shorten the life of the Drone.

Distributed by:
 Electus Distribution Pty. Ltd.
 320 Victoria Rd, Rydalmere
 NSW 2116 Australia

www.electusdistribution.com.au

Made in China