

# QUAD BLADE

4 CHANNEL 2.4GHz  
NANO RC QUADCOPTER



GT-3950



# SAFETY NOTES

## **CAUTION**

The product can be a dangerous toy. Please take care to fly the unit away from people and pets, avoiding heat, power lines and power sources.

The manufacturer and distributor of this product will not be liable for any damages incurred by using this product incorrectly.

Never disassemble any part of the PCB or any other internal components.

## **KEEP AWAY FROM MOISTURE**

R/C quadcopters are composed of many precise electrical components. It is critical to keep the unit and accessories away from moisture and other contaminants. The exposure to liquid or moisture in any form can cause the unit to malfunction. **DO NOT** expose to liquid or moisture as this will void your warranty.

## **KEEP AWAY FROM HEAT**

R/C quadcopters are made of various forms of plastic. Plastic is very susceptible to damage or deformation due to extreme heat and cold climates. Make sure not to store the unit near any source of heat such as an oven or heater. It is best to store the model indoors, in a climate-controlled room temperature environment.

## **PROPER OPERATION**

To avoid potential fire hazard from batteries, please do not short, insert in reverse polarity, or puncture batteries. Battery charging must be done under supervision at all times, and at location out of reach by children.

## **SAFETY FOR NI-MH BATTERIES**

Make sure the batteries are installed based on the polarity indicated in the case and **DO NOT** mix new and old batteries or batteries of different chemistry or specification. Please take out the batteries if you are not going to use the product for a long time to avoid potential leakage which may damage the unit. Please dispose of used batteries in the correct way.

## **SAFETY FOR LI-POLYMER BATTERIES**

Li-Polymer batteries poses higher operational risks compared to other batteries, thus it is imperative to follow its usage instructions. The manufacturer and distributor of this product will not be liable for damages caused by improper usage.

**DO NOT** use the charger other than the factory supplied unit to avoid potential fire and explosion.

**DO NOT** crush, disassemble, burn, or enter in reverse polarity. Avoid metallic materials coming into contact with the battery as this will cause the battery to short. **NEVER** puncture batteries and avoid fire hazards.

Battery charging must be done under supervision at all times, and at a location out of the reach of children.

Please stop the use or charge of the battery should there be an unusual increase in battery temperature after use. Continue use of this battery may cause it to expand, deform, result in fire, or even explosion.

Please dispose of used batteries in the correct way.

## **OBTAIN THE ASSISTANCE OF AN EXPERIENCED PILOT**

The products are suitable for people over the age of 8 years old.

In the beginning, the quadcopter may be difficult to learn to operate. Ask for guidance from an experienced user if help is needed.

# ACCESSORIES

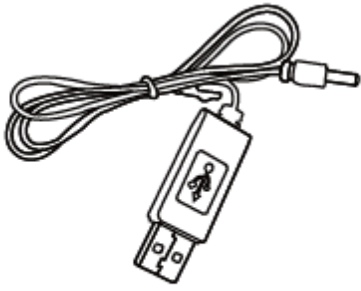

**Li-po charger**

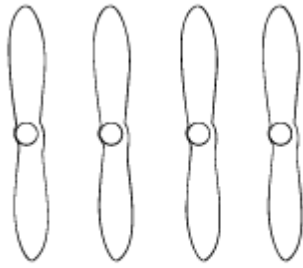

**Blade X 4**

# PARTS EXPLANATION

Quadcopter Top View

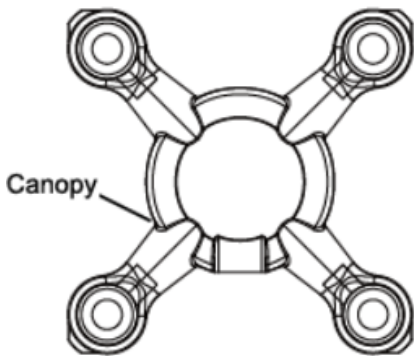

Canopy

Quadcopter Top View without Canopy

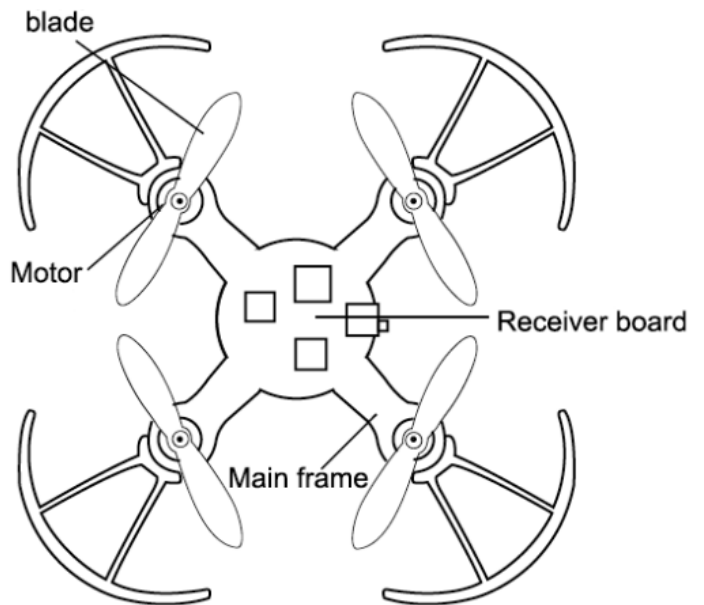

blade

Motor

Receiver board

Main frame

Remote Control Bottom View

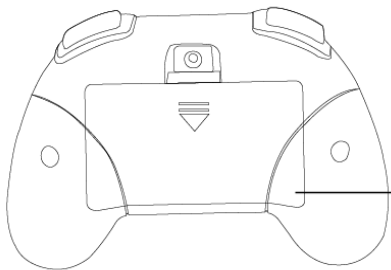

Battery lid

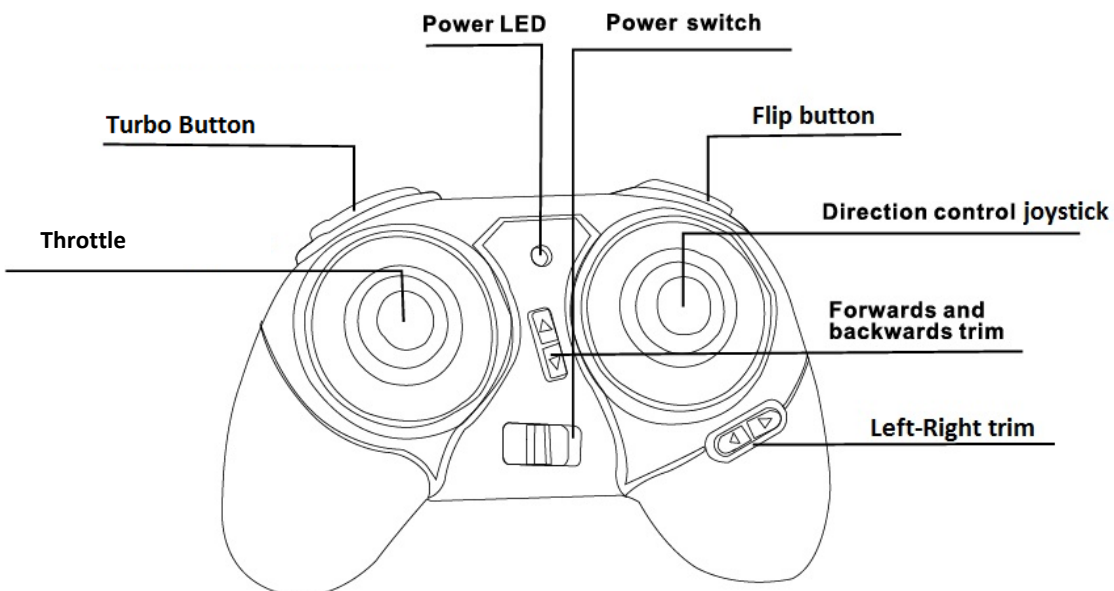

## REMOTE CONTROL BATTERY INSTALLATION

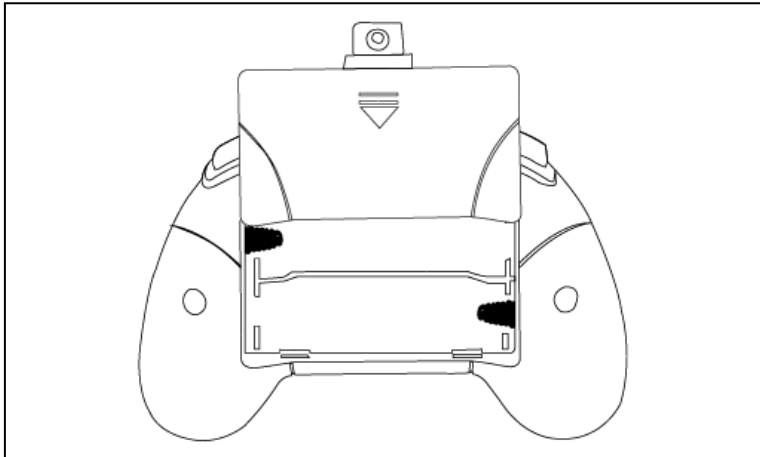

Use a screwdriver to loosen the screws on the remote control battery cover. Open the battery Cover

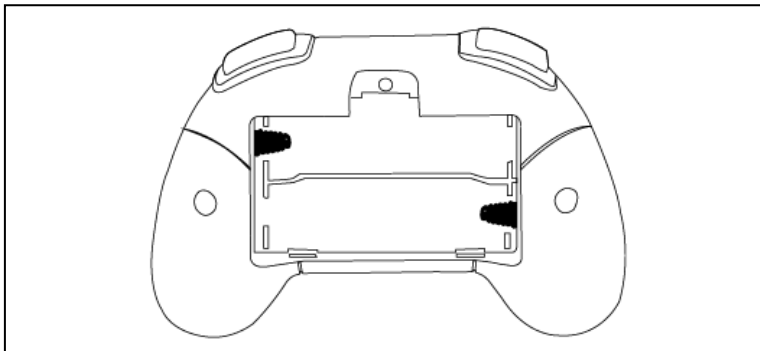

Insert 2 x AA batteries in the correct polarity, as indicated on the unit. Do not mix new and old batteries, or batteries of different specification.

## CHARGING THE BATTERIES

Plug the USB charger into the quadcopter. The red charging light will turn on when the charging is complete.

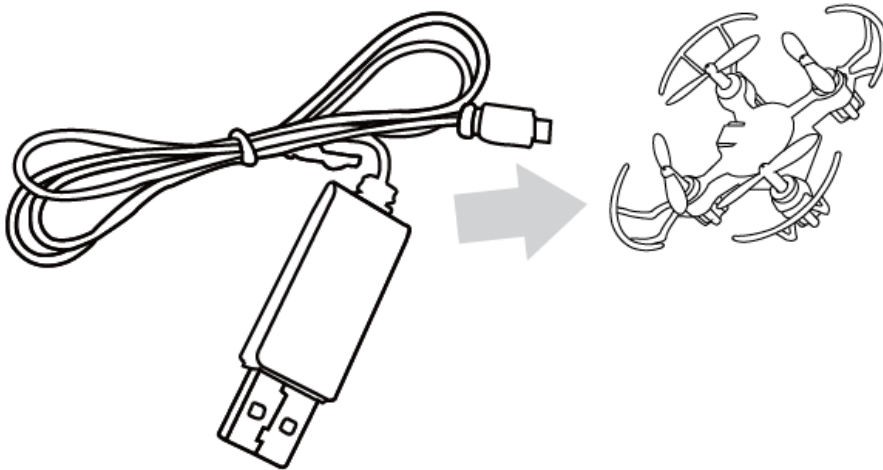





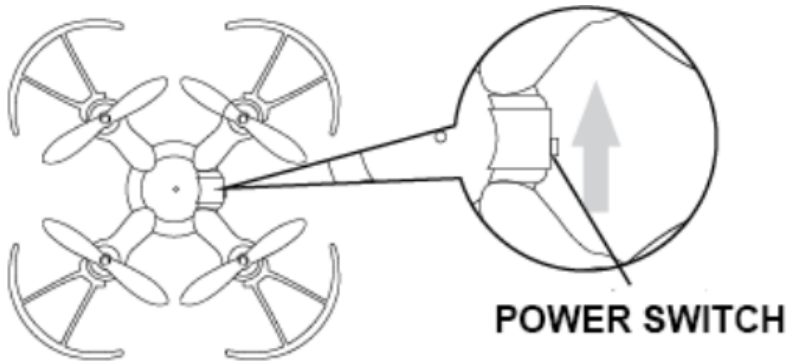
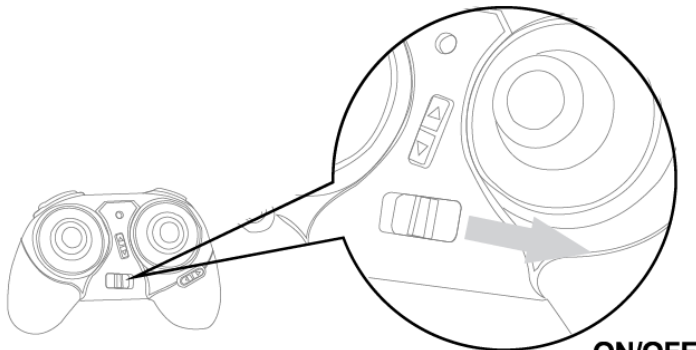

## BATTERY AND CHARGER SPECIFICATIONS

Battery Location	Battery Specification	Usage Duration	Charge Time
Quadcopter	3.7V 100mAh	Flight time approx. 4 mins	Approx. 30 mins (Charging current approx. 0.2A)
Remote Control	1.5V	Approx. 18 hours	N/A

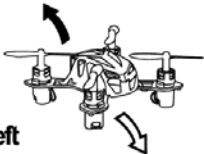
# SYNCING THE REMOTE CONTROL TO THE QUADCOPTER

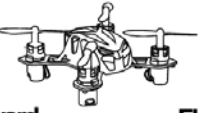
	<p><b>Step 1:</b> Turn on the power of the quadcopter by flipping the power switch located on the underside. Place the quadcopter on a flat surface so that the gyroscope can calibrate. The status indicator will flash during calibration.</p>
	<p><b>Step 2:</b> Turn on the power of the remote control by flipping the power switch. Push the throttle from the lowest to the highest, and then back to the lowest. The syncing is now complete.</p>

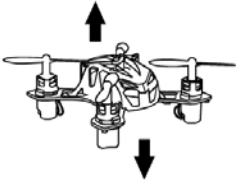
## Remote Action

Remote Action	Quadcopter Movement
<p>Direction Joystick Left/Right</p> 	 <p>Move left      Move right</p>
<p>Direction Joystick Up/Down</p> 	 <p>Fly forward      Fly backward</p>
<p>Throttle Joystick Up/Down</p> 	 <p>Ascent Descent</p>
<p>Throttle Joystick Left/Right</p> 	 <p>Turn left Turn right</p>

# TRIM ADJUSTMENT

## Adjustment of the Left/Right Trim:

- If the quadcopter keeps leaning to the left, please adjust the trim (left/right) to the RIGHT until it stops flying to the left.
- If the quadcopter keeps leaning to the right, please adjust the trim (left/right) to the LEFT until it stops flying to the right.

**Mode**

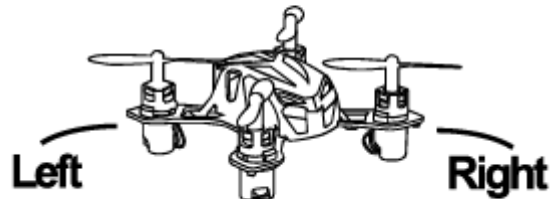

## Adjustment of the Forwards/Backwards Trim:

- If the quadcopter keeps going forward, please adjust the trim (forward/backward) DOWN until it stops flying forward.
- If the quadcopter keeps going backward, please adjust the trim (forward/backward) UP until it stops flying backward.

**Mode**

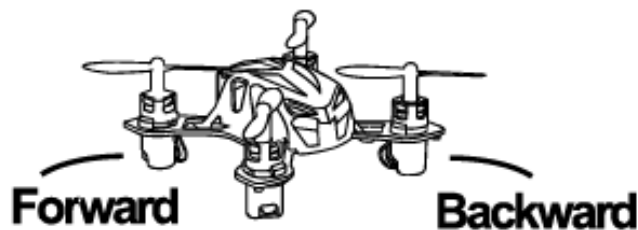

# HEADLESS MODE

## Using Headless Mode:

In the Headless mode setting, it eliminates a quadcopters front and rear and follows the controllers orientation. If the controller is pushed forward, the quadcopter will move forward regardless of where the quadcopters front is facing. The same goes for left/right and backwards control. This makes the quadcopter control much easier, specially flying at great distances where making out quadcopter orientation is difficult. If the quadcopter keeps leaning to the right, please adjust the trim (left/right) to the LEFT until it stops flying to the right.

- To activate headless mode, push the 'direction control joystick' down towards the remote control, like a button.
- To disable headless mode, repeat the above procedure.
- *Note: Headless mode will automatically disable if the quadcopter falls to the ground and stays down for more than 1 second.*

Distributed by:  
TechBrands by Electus Distribution Pty. Ltd.  
320 Victoria Rd, Rydalmere  
NSW 2116 Australia  
Ph: 1300 738 555  
Int'l: +61 2 8832 3200  
Fax: 1300 738 500  
[www.techbrands.com](http://www.techbrands.com)