

Uniden®

**UH810S, -2, -2TP
UH820S, -2, -2TP**

Handheld UHF-CB Transceiver

For more exciting new products please visit our website:
Australia: www.uniden.com.au

OWNER'S MANUAL

Warning

LITHIUM ION BATTERY PACK WARNING

- This equipment contains a Lithium Ion Battery Pack.
- The Lithium Ion Battery Pack contained in this equipment may explode if disposed of in a fire.
- Do not short-circuit the Battery Pack.
- Do not charge the Lithium Ion Battery Pack used in this equipment in any charger other than the one designed to charge this Battery Pack. Using another charger may damage the Battery Pack or cause the Battery Pack to explode.
- Lithium Ion batteries must be disposed off properly.



NOTE

USER LICENSE INFORMATION

The citizen band radio service is licensed in Australia by ACMA Radio-communications (Citizen Band Radio Stations) Class Licence and in New Zealand by MED General User Licence for Citizen Band Radio and operation is subject to conditions contained in those licenses.

Contents

Introduction	4
Included in your Package	5
Controls and Indicators	6
Getting Started	
Connect Drop-in Charger with the AC Adaptor	7
Attaching the Antenna	7
Attaching the Battery Pack	8
Attaching the Beltclip	8
Charging the Battery Pack	9
Battery Level Display	10
Accessory Jack Cover	11
Connecting the SPKR/MIC	11
Operation	
Power On/Off	12
Volume	12
Setting the Squelch	12
Selecting Channel	13
To Transmit and Receive	13
To Operate in Duplex Mode	14
Transmit Power Select	15
Smart-key Function	15
Scanning	15
Master Scan (M.SCN) Mode	17
Open Scan (OS) Mode	20
Group Scan (GS) Mode	21
Priority Channel	22
Drop-Out Delay	22
Instant Priority Channel	22
Monitor	23
CTCSS	23
DCS	24
VOX	24
Busy Channel Lock-out (BCL)	25
Call Tone	25
Roger Beep	26
Key Beep	26
Keypad Lock	27
Backlighting	27
Voice Enhancer (EQL) Setting	27
CTCSS Codes and Frequencies	28
DCS Codes Table	29
UHF-CB Channel Guidelines	30
UHF-CB Channels and Frequencies	31
Warranty	33

Introduction

The UH810S/UH820S Series is a portable two-way UHF-CB radio. Its compact, rugged and fits easily in your hand. This hand held UHF-CB radio will give you consistent, outstanding performance in general conditions and situations. To ensure that you get the most from the radio features, please read this operating guide carefully before using the unit.

FEATURES

- Designed and Engineered in Japan
- 80 Narrowband Channels¹
- 2.0 Watt Maximum TX Output Power (UH820S series)
- 1.0 Watt Maximum TX Output Power (UH810S series)
- Long Life 1600mA Lithium-ion Battery (UH820S series)
- 1000mA Lithium-ion Battery (UH810S series)
- 4-Way Voice Enhancer
- One-Touch Smart Key
- Range Extender (Duplex) Capability
- VOX Hands Free Capable
- Interference Eliminator (CTCSS)
- Digital Coded Squelch (DCS)
- Backlit LCD Display
- Auto Battery Save
- Open Scan
- Group Scan
- Master Scan
- Rapid scan speed
- Battery Level Indicator
- Busy Channel Lockout Function
- Roger Beep
- Keypad Lock

¹ Refer to p.30 - p.32 for channel information

Included in your Package

ITEM	UH810S	UH810S-2	UH810S-2TP	UH820S	UH820S-2	UH820S-2TP
UH820S UHF Radio	--	--	--	1	2	2
UH810S UHF Radio	1	2	2	--	--	--
1600mAh Li-Ion Battery Pack (BT820)	--	--	--	1	2	2
1000mAh Li-Ion Battery Pack (BT810)	1	2	2	--	--	--
Belt Clip	1	2	2	1	2	2
Drop-In Charger (DT820A)	--	1	1	--	1	1
AC Adaptor (PS-S05C0BU4)	1	1	1	1	1	1
USB-DC (Cigar) ADAPTOR (AD-1243)	--	--	--	--	1	1
USB Cable	1	1	1	1	1	1
External Speaker MIC.	--	--	--	--	--	2
Earpiece MIC.	--	--	2	--	2	2
Battery Jacket	--	1	2	1	2	2
OWNERS MANUAL	1	1	1	1	1	1
Carry Case	--	--	1	--	--	1
Extra Face Plate	--	--	--	--	--	2

Optional Accessories

External Speaker MIC (SM-800)

Heavy Duty Earpiece MIC with VOX switch (EM-800)

Air Tube Headset with VOX switch (TM-800)



If any of these items are missing from the box, contact your place of purchase, immediately.

Controls and Indicators

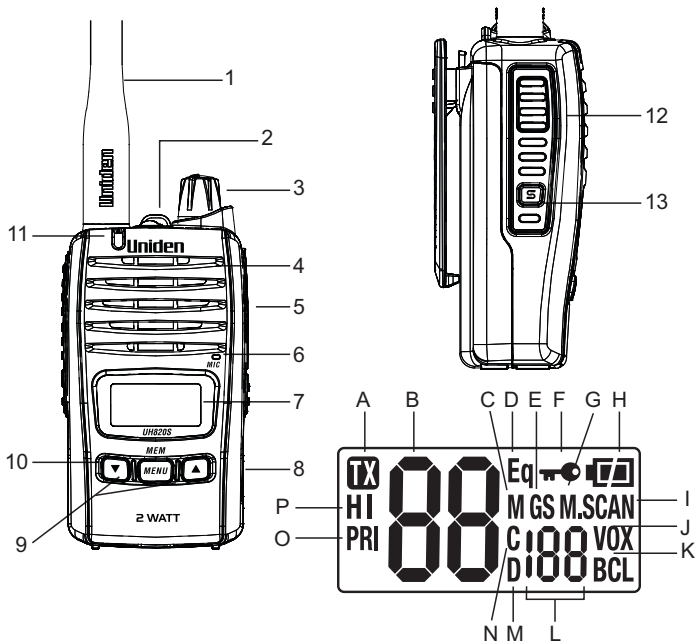

- | | | | | | |
|----|-----------------------|---|---------------------|---|-----------------|
| 1 | Antenna | A | Transmit | L | CTCSS/DCS |
| 2 | SCAN/MON | B | Channel Indicator | | Code Indicator |
| 3 | Rotary Vol/Power Knob | C | Scan CH Memory | M | Digitally Coded |
| 4 | Speaker | D | Equalizer indicator | | Squelch |
| 5 | Accy Speaker MIC Jack | E | Group Scan and | N | Continuous Tone |
| 6 | Microphone | | Master Scan | | coded Squelch |
| 7 | LCD Display | F | Key Lock | | System |
| 8 | USB Charge port | G | Master Scan | O | Priority Watch |
| 9 | UP and DOWN Keys | H | Battery Indicator | P | High Power |
| 10 | MENU [MEM] Key | I | Scanning | | |
| 11 | LED | J | VOX | | |
| 12 | PTT KEY | K | Busy Channel | | |
| 13 | SMART KEY | | Lockout | | |

Getting Started

Connect Drop-in Charger with AC Adaptor

Plug one end of the USB cable into the drop-in charger and the other end to the AC adaptor. Plug the AC adaptor into the wall outlet.

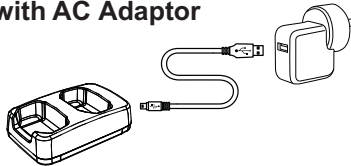

OR...

Connect the USB cable to the DC Adaptor

Included only with the UH820S-2/UH820S-2TP and connect the DC Adaptor to a Cigarette Lighter Jack.

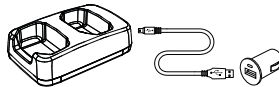

OR...

Connect the USB cable directly to the charge jack of the radio.



NOTE

The drop-in charger and DC charging adaptor are not water proof. Ensure the radio is dry before connecting to the charger. Don't use the chargers when the ambient temperature is below 5° C (37° F) or above 40° C (108° F) Input Voltage (Cigarette Lead Charger): +12VDC to +24VDC. If Charge LED didn't light up, please confirm the above temperature.

Attaching the Antenna

Attach the antenna to the radio.
Be sure the antenna is firmly seated.



Getting Started

Attaching the Battery Pack

The UH810S and UH820S series radios can be powered with a lithium ion battery pack or with optional 3xAA batteries fitted into the battery jacket.

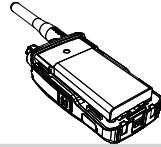

NOTE

The radio can be charged in the drop-in cradle on only when the rechargeable lithium-ion battery is fitted.

1. Remove COVER BATTERY
2. Place the battery pack onto the back of the radio. It will only fit one way.
3. While holding down the locking hook, slide COVER BATTERY onto the back of Radio.
4. Completely slide in and then release the locking hook.



CAUTION

Avoid exposing the Lithium Ion battery, attached or unattached to the radio, in direct sunshine, heated cars, or in areas with temperatures below -20°C (-4°F) or above $+60^{\circ}\text{C}$ ($+140^{\circ}\text{F}$).

Exposing the chemicals contained within the battery pack to temperatures above $+60^{\circ}\text{C}$ ($+140^{\circ}\text{F}$) may cause the battery to rupture, fail or reduce performance.

In case of exposure to cell contents, wash the affected area thoroughly, and seek medical attention.

Additional battery cautions should be applied as described on p.2.

To Attach the Belt Clip:

Slide the belt clip into the catch until it snaps into place.

To Remove the Belt Clip:

Pinch and hold the belt clip latch and then slide the belt clip up and out of the catch.

Getting Started

Charging the Battery Pack

Your radio is powered by a specially designed Lithium Ion battery pack.

- Before operating the radio, charge the Lithium Ion battery pack for 4 hours (UH820S) or 3 hours (UH810S) without interruption in the drop-in charger.



For the initial battery charge, make sure the radio is off for optimum charging.

The drop-in charger can charge the Lithium Ion battery pack attached to the radio, in the front charging slot.

1. Place the radio, in the drop-in charger.
2. The red LED illuminates and stays ON, until fully charged.
 - The charger won't overcharge the battery packs.
3. The green LED illuminates and stays ON after charging is completed.
 - **Do not transmit when the radio is charging; in the drop-in charger or when connected to the DC adaptor!**
 - You can monitor incoming calls while the radio is in the drop-in charger.

Getting Started

Battery Level Display

The BATTERY icon at the top of the screen indicates the battery level at all times. The battery level is displayed in 4 levels.

LEVEL 4
Battery 100% full



LEVEL 3
Battery approx. 40% capacity



LEVEL 2
Low Battery



LEVEL 1
(flashing)
Empty Battery



At LEVEL 2, low battery alert will be sounded every 15 minutes.



NOTE

When **(PTT)** is pressed at Level 1, an error tone sounds and transmission is disabled. Once at Level 1 the unit will automatically shutdown after 30 seconds.



NOTE

Recharge the battery at any time. When the battery is empty, it will take up to 4 hours (UH820S) or 3 hours (UH810S) to fully charge.

Battery Life: More than; 21 hours (UH820S) or 15 hours (UH810S)

This is based on the following Duty Cycle:

Transmit (Low Power) 5%
Receive 5%
Stand-by 90%

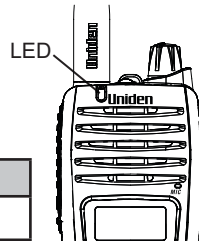

LED Status

LED	What it Indicates
Green	Start Up/Power on
Green Flash	Monitor mode
Green	Receiving Signal
Red	Transmitting signal

Getting Started

Accessory Jack Cover

Make sure the Accessory Jack Cover is firmly pushed in to maintain submersible rating.

Connecting the Earpiece MIC or SPKR/MIC.

Release the Accessory Jack Cover to plug in the **Earpiece MIC** or **SPKR/MIC**.

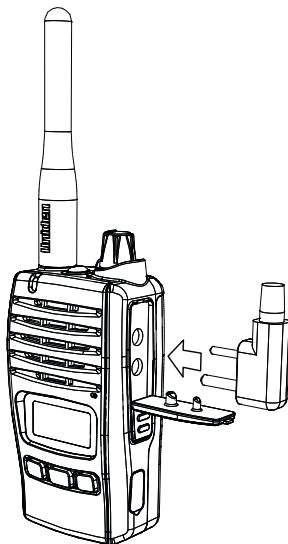

Operation

Power On/Off

1. To turn the unit **ON**, rotate the **[ON/OFF VOL]** knob clockwise. A channel number and battery level should appear on the display.
2. To turn the unit **OFF**, rotate the **[ON/OFF VOL]** knob counter-clockwise. The display will disappear.

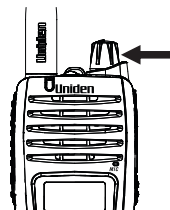

Volume

Rotate the **[ON/OFF VOL]** knob clockwise or counter-clockwise to adjust speaker volume to desired listening level.

Setting The Squelch

The squelch is used to eliminate any annoying background noise when there are no signals present.

Auto/Sq 1 - max sensitivity (min squelch)
Sq 5 - min sensitivity (max/tight squelch)

1. Press **[MENU/MEM]** 2 times. **Sq** and the current squelch level will flash on the display.
2. Use **▲** or **▼** to change the squelch level from Auto/1 to 5.
3. Press & hold **[MENU/MEM]** to save and exit.



Operation

Selecting A Channel

Press ▲ or ▼ to select the desired channel.



NOTE

If you press and hold ▲ or ▼ the channel numbers will scroll rapidly.

To Transmit and Receive

The radio uses the UHF-CB Channels. For your reference a list of the available channels and corresponding frequencies is printed on p.31 - p.32. (Channels 22 and 23 are for telemetry and telecommand applications, channels 61, 62 and 63 are for future use. TX is inhibited on these channels.)

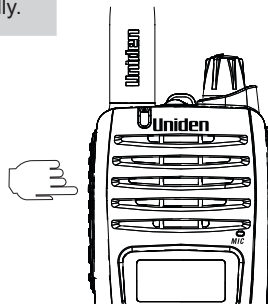

The maximum RF transmit power of UH810S is 1.0W and UH820S is 2.0W. (see Transmit Power Select, p.15.)

1. Before you transmit, listen for activity on the selected channel.
2. When the channel is clear;
 - Press **[PTT]** to transmit at the selected Hi/Lo transmit power, **TX** appears on the LCD and LED lights red during transmit.

Hold the radio with microphone approximately 5cm in front of your mouth with the antenna at approximately 45° angle away from your head. Speak in a clear, normal conversational voice.

4. When you have finished speaking, release **[PTT]** and listen for a response then TX disappears on the LCD. LED lights green while receiving a signal.

Operation

To Operate In Duplex Mode (Repeaters)

The Duplex function enables you to access local repeater stations.



NOTE

You can only activate Duplex on CH01-CH08 and CH41-CH48.

UHF CB Repeaters are used to retransmit or relay your signal. Repeaters will extend the range of your radio and overcome the shielding effect caused by solid obstructions.

Eg. CH01 is being used in your area for repeater use.

1. Press **[MENU/MEM]** 4 times.
2. Press **▲** or **▼** to change the selection. **r** appears for CH01-CH08 and **n** appears for CH41-CH48 when duplex is selected.
3. Press & hold **[MENU/MEM]** to save and exit.



NOTE

Contact your retailer for a list of repeaters available in your area.

Operation with the aid of a Repeater

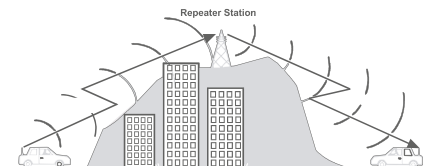

Operation

Transmit Power Select

This radio has two transmit power levels:
Hi: 1.0 Watt (UH810S) / 2.0 Watt (UH820S)
Lo: 0.5 Watt.

To change your transmit power level:

1. Press **[MENU/MEM]**.
2. Press **▲** or **▼** to change the setting to **Hi** or **Lo**.
3. Press & hold **[MENU/MEM]** to save and exit.



TX Power High



TX Power Low

Smart-key Function

The smart key **[S]** provides one touch access to one of these functions; Instant Channel, Call Tone, **Voice Enhancer** or **Key Lock**.

Press & hold **[S]** to change the smart key function between the four options.

Scanning

There are 3 scanning modes;
Open Scan (OS),
Group Scan (GS) and
Master Scan (M.SCN) (a special case Group Scan)

During SCAN the radio only checks channels or frequencies that are in the SCAN Memory, which are indicated by the M (memory) icon. The radio maintains two SCAN Memories; one for Open Scan (OS) mode and the other for Group Scan (GS) mode, to give you flexibility and allow you to use the radio more effectively.



Group Scan and Master Scan modes share the same SCAN Memory.

Operation

To initiate scanning,

1. Press **[SCAN/MON]** to start Scanning.
2. The SCAN icon flashes.
3. The scan direction can be changed at any time by pressing ▼ or ▲.
4. Press **[SCAN/MON]** to start Scanning.

To select scan mode,

1. Press **[MENU/MEM]** 7 times.
2. Press ▲ or ▼ to change the setting to M.SCAN (Master Scan), SCAN (Open Scan) or GS SCAN (Group Scan)
3. Press & hold **[MENU/MEM]** to save and exit.
The selected scan mode appears on the display.

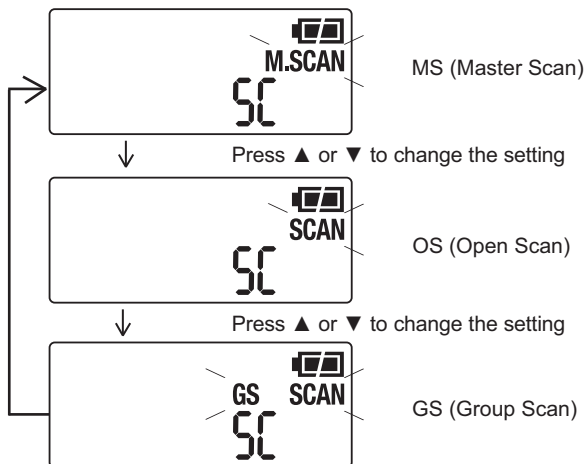

Operation

Add/Remove Channels from Memory

1. Select which Scanning Mode you wish to use on the channel OS, GS or M.SCAN Mode.



NOTE

OS is indicated by the absence of the GS or M.SCAN icon.

2. Select the channel you want to store by pressing ▼ or ▲.
3. Press and hold **[MENU/MEM]** to store.
4. To remove the channel from Memory, Press and hold **[MENU/MEM]** to remove. M icon disappears.

MASTER SCAN Mode

MASTER SCAN is the default scan mode and is enabled to allow continual communication across congested channels.

Master Scan scans channels stored into GS Memory and only opens the squelch for signals with the correct subcode (CTCSS or DCS tone).

To achieve this, all radios in your group must have the same channels in GS memory (group channels) and use the same Subcode (CTCSS or DCS tone).

By scanning only group channels, radios in the network will be able to detect and receive group transmissions- continual communication without interruption. When transmitting in this mode, the radio switches to an unused group channel if it detects another signal with no code, or the wrong code, on the channel last used by the group. In this way, all group users will be able to have continual communication to or from other users.

CH09-CH20 are stored into GS Memory and CTCSS01 is set for MASTER SCAN Subcode by default. The GS memory can be changed,

Operation

channel by channel, if desired, but for Master Scan to work effectively each radio in the group must have the same channels in its GS memory.

To add/remove channels from GS SCAN Memory, refer the section above.



NOTE

RX only Channels (CH22, CH23, CH61, CH62 and CH63) will not be included in MASTER SCAN Mode even though stored into GS Memory. Also channels for which Duplex Setting are On will be skipped in MASTER SCAN Mode.

To operate in MASTER SCAN mode,

1. Press [MENU/MEM] 7 times.
2. Press ▲ or ▼ to change the setting to M.SCAN (Master Scan), SCAN (Open Scan) or GS SCAN (Group Scan)
3. Press & hold [MENU/MEM] to save and exit.

To change MASTER SCAN settings,

1. Press [MENU/MEM] key 8 times. The **M.SCAN** setting flashes.
2. Change to the following setting by pressing ▼ or ▲.

P-: Master Scan uses current CH in GS memory

P1: Master Scan uses CH09-20 in GS.

P2: Master Scan uses CH21-30, 39, 40 in GS.

P3: Master Scan uses CH49-60 in GS.

P4: Master Scan uses CH61-70, 79, 80 in GS.

Operation

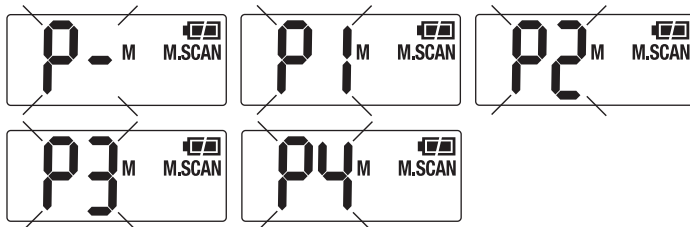

3. Press **[MENU/MEM]** one more time.
4. Select the desired Subcode (CTCSS DCS) or by pressing ▼ or ▲.

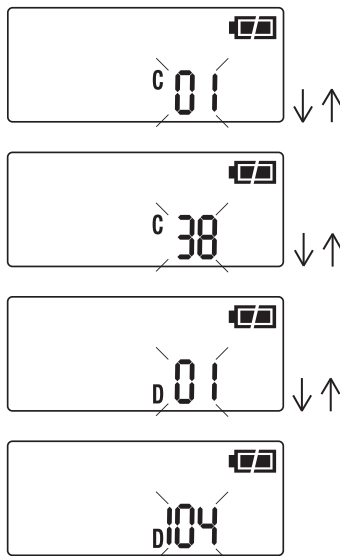

Operation

5. Press and hold the **[MENU/MEM]** to save and exit from the Menu Mode.



NOTE

If a button is not pressed within 10 seconds the UHF CB Radio will automatically exit the Menu Mode.

Open Scan (OS) Mode

All UHF-CB have been added to the OS SCAN Memory for convenience. To add/remove channels from OS SCAN Memory, refer to p.17.

Allows continuous scanning of all selected channels. If an active channel is found, scanning will stop on that channel. If the received signal ceases, the unit will wait 2 seconds for the signal to return, otherwise scanning resumes.

After transmission in scan mode, the scan mode will be cancelled.

To select OS scan mode,

1. Press **[MENU/MEM]** 7 times.
2. Press **▲** or **▼** to change the setting to SCAN (Open Scan).
3. Press & hold **[MENU/MEM]** to save and exit.



NOTE

OS Mode is indicated by the absence of the GS and M.SCAN icons.



NOTE

If SCAN is deactivated while on an active channel, the radio will stay on that active channel. If no channels are active, the radio will reinstate the starting channel.

Operation

Group Scan (GS) Mode

GS Mode has CH09 to CH20 in the SCAN Memory by default. Channels must be stored to the GS SCAN Memory before group scan can start. To add/remove channels from GS SCAN Memory, refer to p.17.

Includes the accessory feature Priority Watch which allows you to monitor the Instant Priority Channel while scanning (see p.22 for setting Instant Priority Channel and p.22 to turn on Priority Watch).

If scanning stops on a channel which is not a Priority Channel, UHF CB Radio will continue monitoring the Priority Channel for activity while listening to the active one.

To select GS scan mode,

1. Press **[MENU/MEM]** 7 times.
2. Press **▲** or **▼** to change the setting to GS SCAN (Group Scan)
3. Press & hold **[MENU/MEM]** to save and exit.

Operation

Priority Channel Watch During Group Scan

The feature allows user to monitor the Instant Priority channel every 1.5 seconds during Group Scanning.

1. Press **[MENU/MEM]** 5 times. **PRI** setting flashes.
2. Press **▲** or **▼** to change the setting on or off.
3. Press & hold **[MENU/MEM]** to save and exit.

Drop-Out Delay

While scanning, the radio stops at a busy channel and receives a signal. When the received signal is over, the unit will wait for 2 seconds for the return of the signal, otherwise, the radio resumes scanning.

Programming the Instant Priority Channel

1. Press **[MENU/MEM]** 6 times. **PRI** and current channel setting flashes.
2. Press **▲** or **▼** to select the desired channel.
3. Press & hold **[MENU/MEM]** to save and exit.

Recalling the Instant Channel

Press **[S]** when Smart Key is set to Instant Channel function.

Operation

Monitor

This feature enables users to listen in for weak signals on the current channel at the press of a button.

To use monitor,

- For continuous listening.
Press and hold **[SCAN/MON]**

A beep tone will be heard and the receiver circuit will stay open, letting in both the noise & weak signals.

- **RX** LED flashes green.
- To return to normal receive mode
Press **[SCAN/MON]**

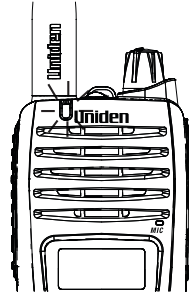

CTCSS

CTCSS is a feature that allows a group to talk to each other without hearing other users on the same channel.

1. Select desired channel.
2. Press **[MENU/MEM]** 3 times.
DCS/CTCSS setting flashes.
3. Press **▲** or **▼** to change the selection.
4. Press & hold **[MENU/MEM]** to save and exit.

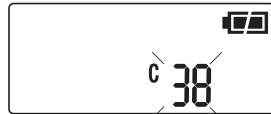
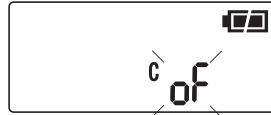

NOTE

Select **oF** to turn DCS/CTCSS off for the selected channel.

Operation

DCS

DCS is a digital extension of CTCSS. It provides 104 extra, digitally coded, squelch codes that follow after the 38 CTCSS codes. CTCSS 1-38, followed by DCS 1-104.

Follow the steps for changing CTCSS code but select DCS code as desired.



NOTE

Channel 05 and 35 are used for emergency channels. CTCSS and DCS will not operate on these two channels.

VOX

VOX is the automatic transmitting function without pressing the PTT key.

VOX appears when VOX level setting is from 1 to 5.

1. Press **[MENU/MEM]** 10 times.
VOX setting flashes.
2. Press **▲** or **▼** to select the desired setting.
The 6 VOX levels are from 1 (low sensitivity) to 5 (high sensitivity) and Off.
3. Press & hold **[MENU/MEM]** to save and exit.

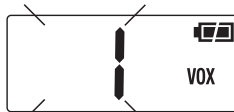

Operation

Busy Channel Lockout

This feature prevents accidental transmission on a busy channel. For example, BCL is used when CTCSS or DCS is selected to prevent transmission when the radio detects a transmission from another unit using the same CTCSS or DCS code.

1. Press **[MENU/MEM]** 11 times.
BCL setting flashes.
2. Press **▲** or **▼** to change the setting on or off.
3. Press & hold **[MENU/MEM]** to save and exit.



Call Tone

The radio is equipped with 5 selectable call tones that will be transmitted when **[S]** is pressed when Smart Key is set to Call Tone function.

1. Press **[MENU/MEM]** 12 times.
CL setting flashes.
2. Press **▲** or **▼** to change the selection.
The 5 call tones are CL 1 to CL 5.
A sample of the call tone is sounded when selected.
3. Press & hold **[MENU/MEM]** to save and exit.



NOTE

Current regulations require calling tones to be restricted to one transmission per minute. If a second transmission is attempted within one minute then an error tone will sound.

Operation

Roger Beep

Roger Beep is a BEEP that is sent to notify the end of transmission (both PTT and VOX transmission.) Roger Beep can be heard through the speaker when Key Beep is on. Roger Beep is transmitted even if Key Beep is turned off. However, Roger Beep will not be heard from the speaker.

1. Press **[MENU/MEM]** 13 times.
rb setting flashes.
2. Press **▲** or **▼** to change the setting on or off.
3. Press & hold **[MENU/MEM]** to save and exit.



Key Beep

Assures the user that the keypad has been properly pressed by emitting a beep tone. This tone can be switched on or off.

1. Press **[MENU/MEM]** 14 times.
bP setting flashes.
2. Press **▲** or **▼** to change the setting on or off.
3. Press & hold **[MENU/MEM]** to save and exit.



Operation

Keypad Lock

To prevent accidental entries, you can lock the keypad. Press and hold **[S]** repeatedly to cycle through the Smart Key modes until the  appears.

To unlock the keypad, press and hold **[S]** again for 1.5 seconds. The  disappears.



NOTE

When the keypad Lock is active, an error tone will be heard if you attempt to press any key, except for the following key function; **(PTT)**.

Back Lighting

The Liquid Crystal Display (LCD) is backlit for easy viewing at night or in low light situations. The back lighting automatically switches ON every time a key (except PTT) is pressed. It turns OFF 5 seconds after the last key is pressed.

Voice Enhancer (EQL) Setting

Choose from 4 different receive audio level settings to provide a natural Voice Enhancer for super clarity and performance.

Press **[S]**, when in Smart key EQL mode, to change the setting between; Off(Normal) /L1(Bass) /L2(Midrange) /L3(High)

CTCSS Codes and Frequencies

Code No.	Frequency (Hz)	Code No.	Frequency (Hz)
"oF'	OFF	20	131.8
1	67.0	21	136.5
2	71.9	22	141.3
3	74.4	23	146.2
4	77.0	24	151.4
5	79.7	25	156.7
6	82.5	26	162.2
7	85.4	27	167.9
8	88.5	28	173.8
9	91.5	29	179.9
10	94.8	30	186.2
11	97.4	31	192.8
12	100.0	32	203.5
13	103.5	33	210.7
14	107.2	34	218.1
15	110.9	35	225.7
16	114.8	36	223.6
17	118.8	37	241.8
18	123.0	38	250.3
19	127.3		

DCS Codes Table

Code No.	DCS Code (Octal)	Code No.	DCS Code (Octal)	Code No.	DCS Code (Octal)
1	023	36	223	71	445
2	025	37	225	72	446
3	026	38	226	73	452
4	031	39	243	74	454
5	032	40	244	75	455
6	036	41	245	76	462
7	043	42	246	77	464
8	047	43	251	78	465
9	051	44	252	79	466
10	053	45	255	80	503
11	054	46	261	81	506
12	065	47	263	82	516
13	071	48	265	83	523
14	072	49	266	84	526
15	073	50	271	85	532
16	074	51	274	86	546
17	114	52	306	87	565
18	115	53	311	88	606
19	116	54	315	89	612
20	122	55	325	90	624
21	125	56	331	91	627
22	131	57	332	92	631
23	132	58	343	93	632
24	134	59	346	94	654
25	143	60	351	95	662
26	145	61	356	96	664
27	152	62	364	97	703
28	155	63	365	98	712
29	156	64	371	99	723
30	162	65	411	100	731
31	165	66	412	101	732
32	172	67	413	102	734
33	174	68	423	103	743
34	205	69	431	104	754
35	212	70	432		

UHF-CB Channel Guidelines



NOTE

Always listen on a channel (or observe the receive signal level meter) to ensure it is not already being used before transmitting.

Channels 5 and 35 are used for emergency channels.

CTCSS, DCS will not operate on these channels.

Please follow these guidelines for channel use in Australia:

- Channels 05 and 35 are Emergency Channels.
- Channel 11 is a Calling Channel.
- Channels 22 and 23 are for telemetry and telecommand applications, channels 61, 62 and 63 are for future use and TX is inhibited on these channels.

General communication is accepted on all other channels with these guidelines:

- Channel 40 - road channel (Australia).
- Channels 01-08 (and 31-38), and Channels 41-48 (and 71-78) are repeater channels.

Important information - 80 Channel UHF-CB channel expansion

To provide all users additional channel capacity within the UHF-CB Band the ACMA introduced narrowband channel use. This allows for additional channels to be added, up to 80 Channels.

This simply means that the new narrowband radio you have purchased will have more channels than older radios. Please refer to the guidelines above and the channel chart for further channel information.

A list of currently authorised channels can also be obtained from the ACMA website in Australia and the MBIE website in New Zealand.



NOTE

Interference / Poor Audio

When a new narrowband radio receives a signal from an older wideband radio the speech may sound loud, however the radio's built-in AVS (Automatic Volume Stabilizer) circuit will detect and manage incoming audio to comparable levels.

Narrowband radios operating on CH41 - CH80 may encounter interference from nearby wideband radios transmitting on high power on an adjacent channel (frequency).

When an older wideband radio receives a signal from a new narrowband radio the speech may sound quiet - the wideband radio user simply adjusts their radio volume for best performance.

The above situations are not a fault of the radio but a symptom of mixed wideband and narrowband radios in current use. It is expected that as older wideband radios are phased out this issue will be eliminated.

UHF-CB Channels and Frequencies

CH No.	Simplex Mode Transmit / Receive Frequency (MHz)	Duplex Mode Transmit Frequency (MHz)	CH No.	Simplex Mode Transmit / Receive Frequency (MHz)
1	476.425	477.175 (CH31)	21	476.925
2	476.450	477.200 (CH32)	22	476.950 (RX only)
3	476.475	477.225 (CH33)	23	476.975 (RX only)
4	476.500	477.250 (CH34)	24	477.000
5	476.525	477.275 (CH35)	25	477.025
6	476.550	477.300 (CH36)	26	477.050
7	476.575	477.325 (CH37)	27	477.075
8	476.600	477.350 (CH38)	28	477.100
9	476.625		29	477.125
10	476.650		30	477.150
11	476.675		31	477.175
12	476.700		32	477.200
13	476.725		33	477.225
14	476.750		34	477.250
15	476.775		35	477.275
16	476.800		36	477.300
17	476.825		37	477.325
18	476.850		38	477.350
19	476.875		39	477.375
20	476.900		40	477.400

UHF-CB Channels and Frequencies

CH No.	Simplex Mode Transmit / Receive Frequency (MHz)	Duplex Mode Transmit Frequency (MHz)	CH No.	Simplex Mode Transmit / Receive Frequency (MHz)
41	476.4375	477.1875 (CH 71)	61	476.9375 (RX only)
42	476.4625	477.2125 (CH 72)	62	476.9625 (RX only)
43	476.4875	477.2375 (CH 73)	63	476.9875 (RX only)
44	476.5125	477.2625 (CH 74)	64	477.0125
45	476.5375	477.2875 (CH 75)	65	477.0375
46	476.5625	477.3125 (CH 76)	66	477.0625
47	476.5875	477.3375 (CH 77)	67	477.0875
48	476.6125	477.3625 (CH 78)	68	477.1125
49	476.6375		69	477.1375
50	476.6625		70	477.1625
51	476.6875		71	477.1875
52	476.7125		72	477.2125
53	476.7375		73	477.2375
54	476.7625		74	477.2625
55	476.7875		75	477.2875
56	476.8125		76	477.3125
57	476.8375		77	477.3375
58	476.8625		78	477.3625
59	476.8875		79	477.3875
60	476.9125		80	477.4125

Warranty

UNIDEN UH810S/UH810S-2/UH810S-2TP and UH820S/UH820S-2/UH820S-2TP CB Transceiver

IMPORTANT: Satisfactory evidence of the original purchase is required for warranty service.

Please refer to our Uniden website for any details or warranty durations offered in addition to those contained below.

Warrantor: The warrantor is Uniden Australia Pty Limited ABN 58 001 865 498 (“Uniden”).

Terms of Warranty: Uniden Aust warrants to the original retail purchaser only that the UH810S/UH810S-2/UH810S-2TP and UH820S/UH820S-2/UH820S-2TP (“the Product”), will be free from defects in materials and craftsmanship for the duration of the warranty period, subject to the limitations and exclusions set out below.

Warranty Period: This warranty to the original retail purchaser is only valid in the original country of purchase for a Product first purchased either in Australia or New Zealand.

Product	3 Years
Battery Pack & Accessories	1 Year

If a warranty claim is made, this warranty will not apply if the Product is found by Uniden to be:

- (A) Damaged or not maintained in a reasonable manner or as recommended in the relevant Uniden Owner’s Manual;
- (B) Modified, altered or used as part of any conversion kits, subassemblies or any configurations not sold by Uniden;
- (C) Improperly installed contrary to instructions contained in the relevant Owner’s Manual;
- (D) Repaired by someone other than an authorised Uniden Repair Agent in relation to a defect or malfunction covered by this warranty; or
- (E) Used in conjunction with any equipment, parts or a system not manufactured by Uniden.

Parts Covered: This warranty covers the Product and included accessories.

User-generated Data: This warranty does not cover any claimed loss of

Warranty

or damage to user-generated data (including but without limitation phone numbers, addresses and images) that may be stored on your Product.

Statement of Remedy: If the Product is found not to conform to this warranty as stated above, the Warrantor, at its discretion, will either repair the defect or replace the Product without any charge for parts or service. This warranty does not include any reimbursement or payment of any consequential damages claimed to arise from a Product's failure to comply with the warranty.

Our goods come with guarantees that cannot be excluded under the Australian Consumer Law. You are entitled to a replacement or refund for a major failure and for compensation for any other reasonably foreseeable loss or damage. You are also entitled to have the goods repaired or replaced if the goods fail to be of acceptable quality and the failure does not amount to a major failure.

This warranty is in addition to and sits alongside your rights under either the COMPETITION AND CONSUMER ACT 2010 (Australia) or the CONSUMER GUARANTEES ACT (New Zealand) as the case may be, none of which can be excluded.

Procedure for obtaining warranty service: Depending on the country in which the Product was first purchased, if you believe that your Product does not conform with this warranty, you should deliver the Product, together with satisfactory evidence of your original purchase (such as a legible copy of the sales docket) to Uniden at the address shown below. You should contact Uniden regarding any compensation that may be payable for your expenses incurred in making a warranty claim. Prior to delivery, we recommend that you make a backup copy of any phone numbers, images or other data stored on your Product, in case it is lost or damaged during warranty service.

UNIDEN AUSTRALIA PTY LTD
Service Division
Phone: 1300 366 895
Email: custservice@uniden.com.au

THANK YOU FOR BUYING A UNIDEN PRODUCT.

Uniden®

© 2015 Uniden Australia Pty Limited. Printed in Vietnam.
U01UT970ZZZ(0)