



TX3100

Super compact 5 watt UHF CB radio



Clear Sound
DSP



Advanced Signal
Management



Dynamic Volume
Control



Mounting
Option

5 YEAR WARRANTY

INSTRUCTION MANUAL

CONTENTS

INTRODUCTION	3	Using Scan	14
IMPORTANT INFORMATION.....	3	Skipping Over Busy Channels While Scanning	15
TELEMETRY CHANNELS.....	4	Transmitting While Scanning.....	15
FEATURES	5	INSTALLATION	15
GENERAL OPERATION.....	6	Antenna Installation	16
Unique Flip Feature.....	7	Noise Suppression	16
Power	7	DC Power Connection.....	19
Volume	7	High Voltage Detection	20
Selecting Channels	7	Antenna Connection.....	20
Transmitting	7	UHF CB OPERATING FREQUENCIES	21
Squelch Control.....	8	CTCSS TONE FREQUENCY CHART	22
Squelch Sensitivity	8	DCS TONE CHART.....	23
Backlight.....	9	SPECIFICATIONS	24
Duplex Operation	9	SC CONTRACT WARRANTY AGAINST DEFECTS	26
Dynamic Volume Control.....	9		
Adjusting the Beep Tone Level	11		
CTCSS & DCS	11		
Selecting the CTCSS or DCS Tone	12		
Enabling CTSS/DCS on a Channel.....	13		
Disabling CTCSS/DCS on a Channel	13		
Monitoring the Channel.....	13		
SCANNING	14		
Programming Scan Channels	14		

INTRODUCTION

The TX3100 is Australian designed and engineered to produce an extremely compact mobile radio with outstanding specifications and performance.

The TX3100, with its front mounted controls, is designed for unobtrusive mounting in modern vehicles. Its innovative features include a built-in loud speaker housed within an extremely compact case.

IMPORTANT INFORMATION CONCERNING UHF CB RADIO

The use of the Citizen Band radio service is licensed in Australia by the ACMA Radio communications (Citizens Band Radio Stations) Class Licence and in New Zealand by the Ministry of Economic Development New Zealand (MED). A General User Radio Licence for Citizens Band radio and operation is subject to conditions contained in those licences.

The class licence for users and equipment operating in the CB/PRS 477 MHz band has been amended. This radio meets the new 80 channel standard.

In simple terms the same amount of spectrum is available; however, radio transceivers can now operate in a narrower bandwidth and hence use less spectrum. These radios are generally referred to as narrowband or 12.5 kHz radios.

By using 12.5 kHz channel spacing instead of 25 kHz, the 40 channels originally allocated can now be expanded to 80 channels thereby doubling the channel capacity and relieving congestion in the UHF CB/PRS band.

Original 40 channel wideband Radios will continue to operate on the original 40 channels, however they will not be able to converse on the newer channels 41 – 80. The newer narrowband radios will be able to converse with all older 40 channel wideband radios on all channels 1 to 40 as well as the newer channels allocated from 41 to 80.

The mixing of narrowband and wideband radios in the same spectrum can cause some possible operating issues of interference and varying levels of received volume.

ACCESSORIES SUPPLIED

Main Radio Unit	Screw Pack
Mounting Bracket	Supplementary GME model label
Instruction Manual	
Microphone	<i>If any items are missing or damaged, please contact your retailer or place of purchase.</i>
Microphone Clip	
DC Lead	

POSSIBLE ISSUES

When a new narrowband radio receives a transmission from an older wideband radio the speech may sound loud and distorted – simply adjust your radio volume for best performance.

When an older wideband radio receives a signal from a new narrowband radio, the speech may sound quiet - simply adjust your radio volume for best performance.

Depending on how close your receiving radio is to another transmitting radio, there can be interference from the transmitting radio if it is using a channel adjacent to the channel you are listening to. Simply try going up or down a few channels from the currently selected channel.

The above situations are not a fault of the radio but a symptom of operating wideband and narrowband radios in the same bandwidth. This possible interference will decrease over time as the population of wideband radios ages and decreases.

The TX3100 uses advanced DSP processing to minimise the possibility of interference on adjacent channels and the need to adjust your volume control to compensate for wide/narrow band reception.

Further information and updates are available from the Australian Communications and Media Authority (ACMA) at www.acma.gov.au and the Ministry of Economic Development (MED), Radio Spectrum Management at: www.rsm.govt.nz

The ACMA has allocated channels 5/35 for emergency use only. Channel 5 is the primary Simplex Emergency Channel. Where a Channel 5 repeater is available, you should select Duplex on CH 5.

NOTE: Channel 35 is the input channel for the Channel 5 repeater therefore Channel 35 should also not be used for anything other than emergency transmissions.

TELEMETRY CHANNELS

ACMA regulations have allocated channels 22 and 23 for telemetry only applications and have prohibited the transmission of speech on these channels. Consequently the TX3100 has a transmit inhibit applied to channels 22 and 23.

In the event additional telemetry/telecommand channels are approved by the ACMA, these channels shall be added to those currently listed where voice transmission is inhibited. Currently transmissions on channels 61, 62 and 63 are also inhibited and these channels are reserved for future allocation.

SAFETY MOUNTING GUIDELINES FOR PLUG 'N' PLAY

The TX3100 Plug 'n' Play (TX3100PNP) is supplied with a suction mount bracket - Part No: MB043, designed to hold the TX3100 UHF CB radio so that it can be remotely mounted onto the windscreen within the vehicle or alternatively on a flat surface where the suction base can take hold.

In order to ensure driver safety when using the TX3100 Plug 'n' Play, GME provides the following recommendations and guidelines;

- The product should not be mounted in a way that blocks the driver's field of vision of the road.
- When mounting on the driver's side of the front windscreen, it is recommended the suction be placed as close as possible to the corner of the windscreen to minimise interruption to the driver's field of vision.
- If fitted elsewhere on the windscreen it should be low down to ensure the driver's field of vision is not blocked.
- If it is not possible or practical due to the design of the dash or the driver's seating position, the unit may be placed low down in the centre of the windscreen.
- The unit must not be located in a position that could potentially cause injury during a crash – such as a head strike to the unit. Airbag deployment should also be considered when mounting the unit.
- Mounting the unit high up on any part of the windscreen is not recommended as it may cause an interruption to the driver's

field of vision or interfere with rear view mirrors and sun visors. It may also result in the DC power lead trailing in the field of vision.

- Deciding on the location of the unit should also factor where power leads may need to run to avoid the possibility of them interfering with or becoming entangled in vehicle controls.
- Covering or restricting access to dash instruments and controls is not recommended.

The responsibility of deciding the location of where the unit is mounted rests entirely with the end-user and should be carefully considered to ensure compliance with any state or federal laws.

FEATURES

- **Microprocessor Controlled Frequency Synthesiser:** Allows user programmable control of scanning, channel memories and selected feature options.
- **Advanced Signal Management (ASM):** Identifies interference caused by strong local signals on adjacent channels and prevents these from opening your squelch. ASM also minimises distortion on reception by fine tuning the receiver frequency to match that of the incoming signal.
- **Dynamic Volume Control (DVC):** Automatically compensates for variations in received audio level resulting in a constant audio output level to the speaker.
- **Programmable Scan Function:** Scans the programmable UHF CB channels.
- **Individually Programmable DUPLEX function:** User selectable for only those individual channels in your area that have repeaters, leaving the others free for use as extra simplex channels.
- **High Contrast Liquid Crystal Display:** Fully detailed LCD provides a visual indication of the selected channel and all selected functions at a glance. Backlit for viewing at night.
- **Flip Feature:** Unit can be mounted with the speaker facing upwards or downwards and the display 'flipped over' using a simple key-press sequence to allow viewing of the display from either mounting orientation. Keys use symbols to provide readability in all installations.
- **Compact Size:** Fits into the smallest locations allowing installations in even the most 'space challenged' environments.
- **CTCSS & DCS:** A built-in Continuous Tone Coded Squelch and Digital Coded Squelch System option provides quiet channel operation.
- **Overvoltage Protection:** Special overvoltage detection circuitry protects the radio and warns of excessive voltage conditions by flashing the display.
- **Surface Mount Technology:** The very latest surface mount component types, design and assembly techniques and quality control procedures are used to ensure the highest performance and reliability.
- **Designed and Engineered in Australia**

GENERAL OPERATION

BASIC CONTROLS

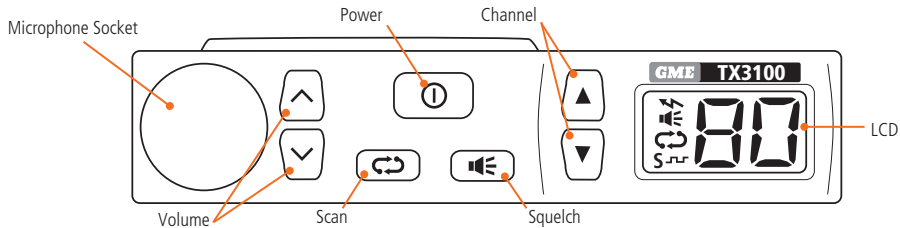

LCD

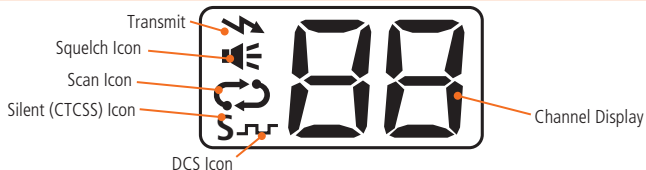

MICROPHONE

Push-To-Talk (PTT)



UNIQUE FLIP FEATURE

The TX3100 has a unique Display Flip function that allows the unit to be installed upside down, if required, and the display read from either orientation.

For more information on this feature please refer to **Flipping the Display** under **Installation** on page 18.

POWER

To turn the TX3100 ON, briefly press the **ⓘ** key.

To turn the TX3100 OFF, press and hold the **ⓘ** key.

VOLUME

Press the **^** or **v** keys to increase or decrease the volume. The radio will beep with each key press and the display will flash to indicate the volume setting is being displayed. The volume level can be set from 00 (min) to 31 (max). The display will stop flashing and will return to displaying the selected channel a few seconds after the last volume adjustment.

NOTE: At the minimum volume setting there is still sufficient volume to be heard in a quiet cabin environment.

SELECTING CHANNELS

Press the **▲** or **▼** keys to step upwards or step downwards through the channels.



TRANSMITTING

To transmit, press the **PTT** button. Hold the microphone about 5-8 cm from your face and speak at a normal voice level. The microphone is quite sensitive so it is not necessary to raise your voice or shout. Release the **PTT** when you have finished talking.

IMPORTANT: Always listen to ensure the channel is free before transmitting.

SQUELCH CONTROL

Squelch control is used to eliminate the background noise when there are no signals present. The TX3100 features a preset Squelch system. The Squelch sensitivity has been factory set to provide optimum performance in most environments, however the sensitivity can be altered by the user if required to suit varying environmental situations.

The Squelch can be opened or closed by pressing the  key. When the Squelch is open, the receiver's background noise can be heard and  is displayed. When the Squelch is closed, the receiver remains quiet when there are no signals present but an incoming signal will override the squelch and be heard in the speaker.

To open the Squelch

Briefly press the  key. A low beep will be heard. If there are no signals present you will hear the receiver's background noise.

To close the Squelch





Briefly press the  key again. A high beep will be heard and the receiver will become quiet.

NOTE: If an incoming signal is very weak and is close to the minimum squelch level, it may become broken or 'chopped' by the squelch action. To prevent this, simply open the Squelch to allow the signal to be heard clearly. Alternatively you can reduce the Squelch sensitivity as described below.

SQUELCH SENSITIVITY



The sensitivity of the Squelch to incoming signals can be set to suit your operating environment. For example, excessively noisy environments may cause the squelch to open on local noise. The TX3100 has nine (9) preset Squelch sensitivity settings.

To adjust the preset Squelch sensitivity

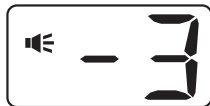
Press and hold the  key while immediately pressing the  or  keys. The  icon will flash and the preset squelch level will be displayed as -1 to -9. The minimum squelch level of -1 is the most sensitive and will allow the squelch to open on very weak signals. Setting the squelch to the maximum setting of -9 will require very strong signals to open the squelch. The default setting is -3 which generally provides reliable squelch operation for most applications.



Setting the Squelch sensitivity

NOTE: After pressing the  key you should begin pressing the  or  keys immediately (within 2 seconds) otherwise the 'Silent' mode may be activated. See **ENABLING CTCSS/DCS ON A CHANNEL** on page 9.

BACKLIGHT

When the radio is on, briefly press the **1** key to cycle through the brightness levels for the LCD and keypad lighting. There are 5 levels of lighting from off to full brightness. Each key press increases the brightness until maximum brightness is reached. The next key press resets the brightness level to off and the cycle repeats.

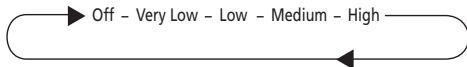

DYNAMIC VOLUME CONTROL (DVC)

The modulation level of signals heard on the UHF CB band has always varied considerably resulting in noticeable differences in received audio volume between stations. Generally users have compensated for this by adjusting the volume control for each received signal. With the introduction of 80 channel narrowband transmissions that use lower levels of modulation, the diversity in received audio volume is likely to increase further.

The TX3100 is able to automatically compensate for these variations in received audio level by utilising a Dynamic Volume Control. This feature automatically compensates for variations in received audio level resulting in a constant audio output level to the speaker to greatly enhance the quality of the reception.

DUPLEX OPERATION

Duplex operation allows the radio to transmit on a different frequency to that which it receives allowing operation through repeater stations. Repeaters automatically re-transmit your signal over a wider area, providing greatly increased range.

Duplex operation operates only on channels 1-8 and 41-48.

When duplex is selected on these channels, the radio receives on that channel but actually transmits 30 channels higher.

Simplex/Duplex Range Comparison

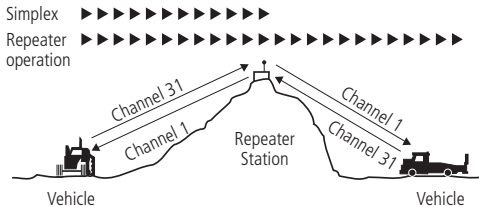



Channel Selected	Receive Channel	Transmit Channel
1	1	31
2	2	32
3	3	33
4	4	34
5*	5*	35*
6	6	36
7	7	37
8	8	38
41	41	71
42	42	72
43	43	73
44	44	74
45	45	75
46	46	76
47	47	77
48	48	78

* Emergency Channel only

The TX3100 allows you to select Duplex operation individually on each channel.

To select Duplex on individual channels;

1. Select the required channel (1 – 8 or 41 – 48).
2. Press and hold the  key and immediately press the  key. The '0' in the channel number will change to 'r' if channel 1 – 8 is selected to indicate that channel is now set as a repeater channel. The '0' in the channel will change to 'u' to indicate the channel is now set as an upper repeater channel, if channel 41 – 48 is selected.

Eg: Channel 2 will be displayed as '02' when in simplex mode but will change to 'r2' when duplex is activated on that channel.

Channel 42 will be displayed as '42' when in simplex mode but will change to 'u2' when duplex is activated on that channel.

Channel 2 Simplex



Channel 2 Duplex (repeater)



Channel 42 Duplex (repeater)



NOTE: You must press the ▲ key immediately after pressing the ↺ key otherwise the scan memory function will be activated. See **SCANNING** on page 14.

ADJUSTING THE BEEP TONE LEVEL

The beep tones on your TX3100 are designed to provide audible feedback whenever a key is pressed. If the beep tone level is too loud or too soft for your operating environment you can adjust it as follows:

1. Turn the TX3100 OFF.
2. Hold either the ^ or v key while turning the radio ON.
3. A number will flash on the display to indicate the current beep tone level setting.
4. Within 3 seconds, press the ^ or v keys to increase or decrease the beep tone level. The maximum level is 9 and the minimum audible level is 1. To turn the beep tone off set the level to 0.
5. To return the radio to normal operation, press any other key or simply wait 3 seconds.

CTCSS (Continuous Tone Coded Squelch System) and DCS (Digitally Coded Squelch) are Squelch quieting systems that allow several groups of users to share the same channel without disturbing each other. The system applies a continuous low-level tone to your transmission and uses a matching tone decoder to control your receiver's Squelch. With CTCSS or DCS enabled, the channel remains quiet to all incoming signals unless they carry the correct tone. When a transmission with the correct tone is received, the Squelch opens and remains open for as long as the signal is present. When the transmission ends, the channel becomes quiet again. Transmissions that do not use the correct tone will not be heard.

There are two tone sets installed in your TX3100, comprising 50 CTCSS and 104 DCS user-selectable tones.

The TX3100 allows CTCSS or DCS to be enabled or disabled on individual channels.

NOTE: The CTCSS/DCS tone you select will be used for all CTCSS/DCS enabled channels in your radio.

SELECTING THE CTCSS OR DCS TONE

Choosing which tone to use will probably be dependent on the other radios you talk to. If you talk to others outside your group who already use CTCSS or DCS tones you will need to select the tone set that matches theirs. The TX3100 includes most of the commonly used tone sets.

If the users you talk to don't currently use CTCSS or DCS you can make your own choice. There is no difference in performance between the two tone sets.

NOTE: When selecting tones please refer to the **CTCSS and DCS Tone Charts** on pages 22 – 23.

The CTCSS and DCS tones are stored in your radio in a sequential table. The first table location is OFF. The next 50 locations are CTCSS tones followed by 104 DCS tones.



OFF → CTCSS 01 to CTCSS 50 → DCS 01 to DCS 104

To select a tone

1. Switch the TX3100 off.
2. Press and hold the  key while switching the radio on. 'S' flashes and the channel number displays the currently selected tone. If OF is displayed the tones are set to **OFF**.

CTCSS Off



3. Press the  or  keys to select the required CTCSS tone. The flashing 'S' indicates the tones you are selecting are CTCSS tones.

CTCSS Tone 24



4. If you advance past CTCSS tone 50 the tone number resets to 01 and the  symbol flashes indicating that you are now selecting DCS tones. Continue advancing through the tones to select your required DCS tone.

DCS Tone 104





NOTE: Since the display does not have enough digits to display DCS tones 100 - 104, these tones are displayed as A0 - A4.

5. Once the required CTCSS or DCS tone is selected, briefly press the  key to exit the tone setting mode. The selected tone will now be used on any channels where the Silent mode is enabled.

ENABLING CTCSS/DCS ON A CHANNEL

Once a CTCSS/DCS tone has been selected, it can be enabled on individual channels.

1. Press the ▲ or ▼ keys to select the required channel.
2. Press and hold the  key. A high beep will be heard and 'S' will appear on the display. If a DCS tone is being used,  will also be displayed.

Your radio is now in 'Silent' mode and will remain muted on that channel unless a signal containing your selected CTCSS/DCS tone is received. Channels that do not have CTCSS/DCS enabled will remain open to all signals.

You may activate CTCSS/DCS on as many channels as you wish except channel 5 which is designated for emergency use.

NOTE: CTCSS/DCS may not work through some repeaters.

DISABLING CTCSS/DCS ON A CHANNEL



Repeat steps 1 and 2 above. A low beep will be heard and 'S' will disappear from the display.

NOTE: You will not be able to activate CTCSS/DCS on any channel if the CTCSS/DCS tone is set to 'OF'.

MONITORING THE CHANNEL

It is useful to be able to temporarily open your radio's Squelch to allow you to listen for signals from other CTCSS/DCS users outside your group. Because their CTCSS/DCS tone is different to yours, your Squelch would normally remain closed, preventing you from hearing them. You can use the  key to open the Squelch and listen to the channel to check that it is clear before transmitting. This will help prevent you from accidentally transmitting over the top of others.

To monitor the channel

Briefly press the  key. If there are no signals present, you will hear the usual hiss of an empty channel. Press the  key again to restore the Squelch to its previous setting.





SCANNING

The TX3100 has a SCAN function that allows a selection of user programmable channels to be scanned for signals. Channels are scanned at 20 channels per second. When a signal is found, scanning will pause on that channel to allow the signal to be heard, then resume scanning when the channel is clear again.

PROGRAMMING SCAN CHANNELS

Your TX3100 is supplied with all 80 UHF CB channels programmed into the Scan memory. Any channels not needed, can be removed if required.

To add or remove channels from the scan memory

1. Ensure that the radio is not already scanning. If it is, briefly press the  key to cancel the scan function.
2. Select the required channel by using the ▲ or ▼ keys
 - If  is visible on the display, the selected channel is already in the scan memory.
 - If  is not visible, then the selected channel is not in the memory.
 - To add or remove the selected channel, press and hold the  key for a few seconds until a beep is heard.
3. Repeat step 2 to add or remove other channels in the scan memory.

To start scanning

To begin scanning, briefly press the  key. A high beep will be heard,  will flash on the display and the radio will begin scanning.

NOTE: If there is only one channel programmed into the Scan memory, a long low beep will be heard when you press the  key and the command will be ignored.

To stop scanning

To cancel the scan, briefly press the  key. A low beep will be heard and  will stop flashing on the display.

USING SCAN

- If a busy channel is found, scanning will pause on that channel to allow the signal to be heard and will remain there for as long as the channel remains busy. Once the channel has been clear for 5 seconds, scanning will resume automatically.
- If your radio is paused on a busy channel and you wish to remain there, briefly press the  key. The radio will exit Scan mode and remain on the busy channel.
- If the radio pauses on a busy channel and you don't wish to listen to the conversation briefly press either of the ▲ or ▼ keys. The radio will skip over that channel and resume scanning from the next channel in the sequence.

SKIPPING OVER BUSY CHANNELS WHILE SCANNING

When scanning, if the radio pauses on a busy channel and you don't wish to listen to the conversation briefly press either of the ▲ or ▼ keys. The radio will skip over that channel and resume scanning from the next channel in the sequence.

TRANSMITTING WHILE SCANNING

When scanning, your radio remembers the last channel on which it transmitted and will automatically return to that channel each time the **PTT** is pressed.

Before scanning, you can define your initial transmit channel by preselecting that channel first before you press the  key. Once scanning has commenced, pressing the **PTT** will pause the scan and your radio will transmit on the preselected channel. If there is no activity on the channel after 5 seconds the scan resumes.

- If scanning pauses on a (different) busy channel and you press the **PTT** during this time, the busy channel becomes your new default transmit channel. If there is no activity on the channel after 5 seconds the scan resumes but subsequent presses of the **PTT** will return you to this new channel. This allows you to continue to use this channel even if pauses in the conversation exceed the 5 second timeout period.
- If the radio stops on another busy channel then restarts without the **PTT** being pressed, your default transmit channel won't change.

INSTALLATION

The TX3100 is supplied with a slim, U-shaped mounting bracket. The bracket can be screwed or bolted in any convenient location in your vehicle (under or above the dash, on the centre console, etc.) using the mounting slots provided in the bracket. The TX3100 contains a built-in speaker and should be installed in a location where the sound can be heard from the driver's position. Alternatively it can be installed in a less audible location and an extension speaker used instead.

The microphone comes complete with a mounting clip. Its light weight design allows it to be mounted in almost any convenient position accessible to the driver.

When installing the radio, avoid mounting it close to heaters or air conditioners. Screw the microphone's clip to a firm surface. Fit the TX3100 into the bracket and tighten the gimbal knobs. Place the microphone in its mounting clip. Finally, plug the microphone into the front panel of the TX3100 and the power and antenna leads into the sockets provided on the rear of the radio.

ANTENNA INSTALLATION

It is essential to select a good quality, high efficiency, 477 MHz antenna. A poor quality antenna or one not designed for the specific frequency band you are using will give very poor performance.

GME have a wide range of suitable 477 MHz UHF CB antennas to suit most installations and applications. We recommend contacting your local GME retailer for advice.

Connect the antenna cable to the rear antenna socket using a PL259 coaxial connector.

NOISE SUPPRESSION

The inherent design of FM transceivers result in a high level of resistance to ignition and electrical interference. However in some installations it may be necessary to take additional steps to help reduce or eliminate noise interference. During installation, try to route the DC battery leads, the antenna lead or any accessory wires away from the engine compartment, ignition or alternator wiring. If the noise continues, it may be necessary to fit a suppression kit in which case we recommend you consult an auto electrician for advice specific to your installation.

Higher frequency electrical interference caused by electric motors can be suppressed directly at the motor terminals.

Fitting the Microphone

Slide Microphone
into the mounting clip

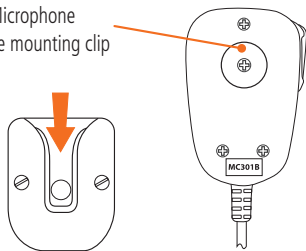

Mounting the Bracket

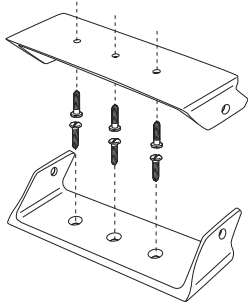

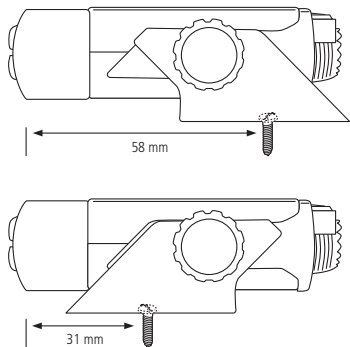

The mounting bracket can be oriented with the arms extending either forward or backwards to adjust the position of the front panel with reference to the mounting point.

Fitting the Radio

Fit radio into bracket and tighten gimbal knobs.

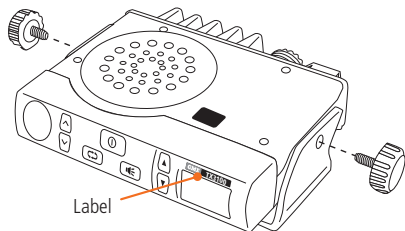

Your TX3100 is fitted with a GME model label adjacent to the LCD. If the final orientation of your radio results in this label being upside down, please fit the supplementary GME label supplied. Simply remove the backing tape and install the supplementary label over the top of the current GME label.

Connecting the Microphone

The microphone uses a 6 pin plug and socket. To connect:

1. Position the microphone plug in the socket so the plastic tab faces away from the speaker, and press the plug into the socket until it 'clicks'.
2. Gently slide the rubber boot towards the hole surrounding the socket and press into place until it locks into the front panel.

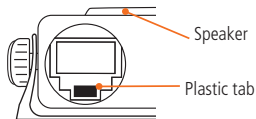

Removing the Microphone

1. Slide the rubber boot back along the microphone cord.
2. Squeeze the plastic tab on the microphone plug towards the plug to unlock it while gently pulling the plug outwards. If the plug does not come out easily, the tab has not released correctly and should be squeezed again.

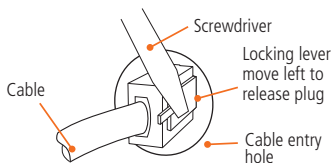

Flipping the Display

The TX3100's small size allows it to be mounted in almost any convenient location. However the most suitable location may sometimes require the unit to be installed upside-down when referenced to your driving position.

The TX3100 is designed to overcome this situation by allowing the display to be 'flipped'. In addition the keys have symbols that can be read from either direction.

You can flip the display as follows.

With the unit installed or held in the required orientation;

1. Turn the unit off.
2. Press and hold the ▲ key while turning the radio on.
3. The display will be flipped to match the radio's orientation.

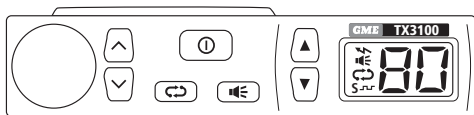

Front Panel Upright (speaker above)

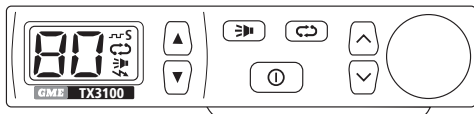

Front Panel Flipped (speaker below)

DC POWER CONNECTION

The TX3100 is designed for 13.8 volts DC, negative earth installations only (i.e. where the negative terminal of the battery is connected to the chassis or frame of the vehicle).

There are two recommended methods of installation.

Radio remains ON when the ignition switch is OFF

Connect the radio's negative (black) lead to the vehicle's chassis, or if preferred, directly to the battery's negative terminal.

The radio's positive (red) lead should be connected via the 2 amp fuse to the battery's positive terminal. Alternatively, the positive lead could be connected into the fuse box at a point that has +13.8 volts continuously available (the battery side of the ignition switch) via the 2 amp fuse.

Radio turns OFF with the ignition switch:

Connect the radio's negative (black) lead to the vehicle's chassis, or if preferred, directly to the battery's negative terminal.

The radio's positive (red) lead should connect to an accessory point in the vehicle's fuse box via the 2 amp fuse. This point should supply +13.8 volts only when the ignition switch is turned ON or in the ACCESSORY position.

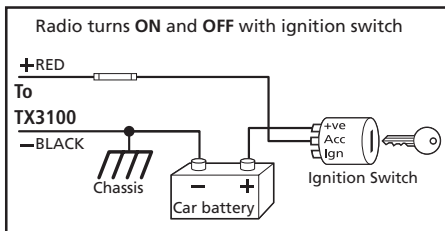
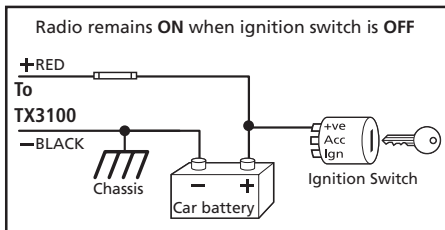

HIGH VOLTAGE DETECTION

The TX3100 has a built-in, high voltage detection system to warn you if an overvoltage situation occurs.

If the power supply voltage exceeds 18 volts DC, the channel display will flash 'hi dc' for 5 seconds when the unit is first turned ON, or at the time the voltage exceeds 18 volts. In addition, when transmitting, the  indicator will flash and the transmitter will select low output power.

If the overvoltage warning appears you should switch your TX3100 OFF and disconnect it from the power source, before locating the cause of the trouble.

Once the high voltage warning has been triggered, and you have fixed the source of the problem, you will need to switch the TX3100 OFF then ON again to reset it.







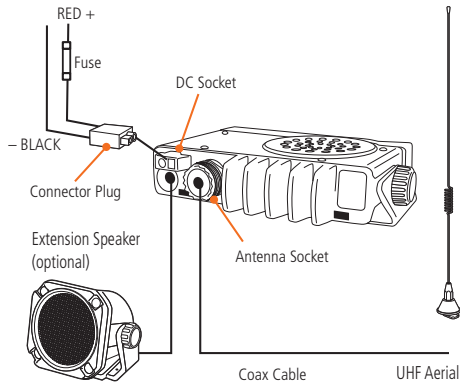

The power source must not exceed 25 volts otherwise permanent damage may occur to your radio, which may not be covered by the manufacturer's warranty.

ANTENNA CONNECTION

GME supply a wide range of mobile and base station antennas designed specifically for UHF CB communications.

The antennas are fitted with a coaxial plug suitable for connection to the antenna socket on the rear panel of the radio.



	Emergency use only		Repeater output channels (Duplex)
	Telemetry / SelCall use only. Voice transmission is inhibited as required by AS/NZS 4365.2011		11 Officially designated call channel
	Guard band channel. Transmission is inhibited as required by AS/NZS 4365.2011		40 Road channel
	Repeater input channels (Duplex)		18 Caravan and motor-home
			10 4WD / Off-road

UHF CB OPERATING FREQUENCIES

CH	Frequency (MHz)	CH	Frequency (MHz)	CH	Frequency (MHz)	CH	Frequency (MHz)
1	476.425	21	476.925	41	476.4375	61	476.9375
2	476.450	22	476.950	42	476.4625	62	476.9625
3	476.475	23	476.975	43	476.4875	63	476.9875
4	476.500	24	477.000	44	476.5125	64	477.0125
5	476.525	25	477.025	45	476.5375	65	477.0375
6	476.550	26	477.050	46	476.5625	66	477.0625
7	476.575	27	477.075	47	476.5875	67	477.0875
8	476.600	28	477.100	48	476.6125	68	477.1125
9	476.625	29	477.125	49	476.6375	69	477.1375
10	476.650	30	477.150	50	476.6625	70	477.1625
11	476.675	31	477.175	51	476.6875	71	477.1875
12	476.700	32	477.200	52	476.7125	72	477.2125
13	476.725	33	477.225	53	476.7375	73	477.2375
14	476.750	34	477.250	54	476.7625	74	477.2625
15	476.775	35	477.275	55	476.7875	75	477.2875
16	476.800	36	477.300	56	476.8125	76	477.3125
17	476.825	37	477.325	57	476.8375	77	477.3375
18	476.850	38	477.350	58	476.8625	78	477.3625
19	476.875	39	477.375	59	476.8875	79	477.3875
20	476.900	40	477.400	60	476.9125	80	477.4125

CTCSS TONE FREQUENCY CHART

50 Tone Set	Frequency	50 Tone Set	Frequency	50 Tone Set	Frequency	50 Tone Set	Frequency	50 Tone Set	Frequency
1	67.0	11	94.8	21	131.8	31	171.3	41	203.5
2	69.4	12	97.4	22	136.5	32	173.8	42	206.5
3	71.9	13	100.0	23	141.3	33	177.3	43	210.7
4	74.4	14	103.5	24	146.2	34	179.9	44	218.1
5	77.0	15	107.2	25	151.4	35	183.5	45	225.7
6	79.7	16	110.9	26	156.7	36	186.2	46	229.1
7	82.5	17	114.8	27	159.8	37	189.9	47	233.6
8	85.4	18	118.8	28	162.2	38	192.8	48	241.8
9	88.5	19	123.0	29	165.5	39	196.6	49	250.3
10	91.5	20	127.3	30	167.9	40	199.5	50	254.1

CTCSS Frequency shown in Hz

DCS TONE CHART

DCS	CODE	DCS	CODE	DCS	CODE	DCS	CODE	DCS	CODE	DCS	CODE
1	023	19	116	37	225	55	325	73	452	91	627
2	025	20	122	38	226	56	331	74	454	92	631
3	026	21	125	39	243	57	332	75	455	93	632
4	031	22	131	40	244	58	343	76	462	94	654
5	032	23	132	41	245	59	346	77	464	95	662
6	036	24	134	42	246	60	351	78	465	96	664
7	043	25	143	43	251	61	356	79	466	97	703
8	047	26	145	44	252	62	364	80	503	98	712
9	051	27	152	45	255	63	365	81	506	99	723
10	053	28	155	46	261	64	371	82	516	A0	731
11	054	29	156	47	263	65	411	83	523	A1	732
12	065	30	162	48	265	66	412	84	526	A2	734
13	071	31	165	49	266	67	413	85	532	A3	743
14	072	32	172	50	271	68	423	86	546	A4	754
15	073	33	174	51	274	69	431	87	565		
16	074	34	205	52	306	70	432	88	606		
17	114	35	212	53	311	71	445	89	612		
18	115	36	223	54	315	72	446	90	624		

SPECIFICATIONS

ENVIRONMENTAL

Temperature Range: -10°C to +60°C

ELECTRICAL

General

Compliant Specification: AS/NZS 4365:2010

Frequency Range: 476.425 – 477.4125 MHz

Number of Channels: 80 UHF CB

Channel Spacing: 12.5 kHz

Operation Mode: Simplex channels 1–80
Semi Duplex channels 1–8, 41–48.

Scanning Speed: 20 channels per second

Antenna Impedance: 50 Ohms nominal

Operating Voltage Range: 10–15 volts DC

Nominal Battery Voltage: 13.8 volts DC

Over Voltage Protection: 25 volts DC max. At 18 volts DC the
RF power is reduced, and the words
'Hi DC' flash.

Over Current Protection: In-line 2A Fuse

Reverse Polarity Protection: Shunt Diode

Frequency Stability: ± 2.5 PPM

Transmitter

RF Output: 5.0 watts max.

Modulation: FM

Maximum Deviation: $< \pm 2.5$ kHz at + 20 dB limiting

Spurious Emissions: < -70 dBc

Transmit Frequency

Response: +6 dB per octave
300 Hz to 3 kHz + 1-3 dB.

Audio Signal to Noise: > 45 dB

Current Consumption: 1.5 amps with 50 Ohms termination

Specifications are typical unless otherwise indicated and may be subject to change without notice or obligation.

Receiver

Circuit Type:	Double Conversion Superheterodyne
Intermediate Frequencies:	1st -38.85 MHz 2nd -450 kHz
Current Consumption:	< 180 mA muted 600 mA @ max. A.F output
Sensitivity:	-123 dBm for 12 dB SINAD unweighted
Selectivity:	-6 dB at + 3.5 kHz -60 dB at \pm 12.5 kHz
Intermodulation Immunity:	73 dB
Blocking Immunity:	100 dB
Spurious Response Immunity:	70 dB
Audio Power:	3 watts average into 4 Ohms
Audio Signal to Noise:	>45 dB
Receive Frequency Response:	-6 dB/Octave de-emphasis 300 Hz to 3 kHz + 1-3 dB
Conducted Spurious Emission:	<-57 dBm

MECHANICAL

Dimensions:	102 (W) x 87 (D) x 23 (H) mm
Weight:	158 grams
Shock and Vibration:	MIL STD 810 method

STANDARD COMMUNICATIONS CONTRACT WARRANTY AGAINST DEFECTS

This warranty against defects is given by Standard Communications Pty Ltd ACN 000 346 814 (We, us, our or GME). Our contact details are set out in clause 2.7.

1. Consumer guarantees

- 1.1 Our goods come with guarantees that cannot be excluded under the Australian Consumer Law. You are entitled to a replacement or refund for a major failure and for compensation for any other reasonably foreseeable loss or damage. You are also entitled to have the goods repaired or replaced if the goods fail to be of acceptable quality and the failure does not amount to a major failure.
- 1.2 To the extent we are able, we exclude all other conditions, warranties and obligations which would otherwise be implied.

2. Warranty against defects

- 2.1 This Warranty is in addition to and does not limit, exclude or restrict your rights under the Competition and Consumer Act 2010 (Australia) or any other mandatory protection laws that may apply.
- 2.2 We warrant our goods to be free from defects in materials and workmanship for the warranty period (see warranty table) from the date of original sale (or another period we agree to in writing). Subject to our obligations under clause 1.2, we will at our option, either repair or replace goods which we are satisfied are defective. We warrant any replacement parts for the remainder of the period of warranty for the goods into which they are incorporated.
- 2.3 To the extent permitted by law, our sole liability for breach of a condition, warranty or other obligation implied by law is limited
- (a) in the case of goods we supply, to any one of the following as we decide -

- (i) the replacement of the goods or the supply of equivalent goods;
- (ii) the repair of the goods;
- (iii) the cost of repairing the goods or of acquiring equivalent goods;
- (b) in the case of services we supply, to any one of the following as we decide –
- (i) the supplying of the services again;
- (ii) the cost of having the services supplied again.
- 2.4 For repairs outside the warranty period, we warrant our repairs to be free from defects in materials and workmanship for three months from the date of the original repair. We agree to re-repair or replace (at our option) any materials or workmanship which we are satisfied are defective.
- 2.5 We warrant that we will perform services with reasonable care and skill and agree to investigate any complaint regarding our services made in good faith. If we are satisfied that the complaint is justified, and as our sole liability to you under this warranty (to the extent permitted at law), we agree to supply those services again at no extra charge to you.
- 2.6 To make a warranty claim you must before the end of the applicable warranty period (see warranty table), at your own cost, return the goods you allege are defective, provide written details of the defect, and give us an original or copy of the sales invoice or some other evidence showing details of the transaction.

- 2.7 Send your claim to: Standard Communications Pty Ltd.
PO Box 96 Winston Hills, NSW 2153, Australia.
Tel: (02) 8867 6000 Fax: (02) 8867 6199
Email: servadmin@gme.net.au
- 2.8 If we determine that your goods are defective, we will pay for the cost of returning the repaired or replaced goods to you, and reimburse you for your reasonable expenses of sending your warranty claim to us.

3. What this warranty does not cover

- 3.1 This warranty will not apply in relation to:
- (a) goods modified or altered in any way;
 - (b) defects and damage caused by use with non Standard Communications products;
 - (c) repairs performed other than by our authorised representative;
 - (d) defects or damage resulting from misuse, accident, impact or neglect;
 - (e) goods improperly installed or used in a manner contrary to the relevant instruction manual; or
 - (f) goods where the serial number has been removed or made illegal.

4. Warranty period

- 4.1 We provide the following warranty on GME and Kingray products. No repair or replacement during the warranty period will renew or extend the warranty period past the period from original date of purchase.

PRODUCT TYPE	WARRANTY PERIOD
477 MHz UHF CB mobile radios	5 years

For more information call or visit us:

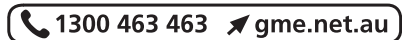

A division of Standard Communications Pty Ltd.

Head Office: PO Box 96, Winston Hills, NSW 2153, Australia.

New Zealand: PO Box 58446 Botany, Auckland, 2163, NZ. T: (09) 274 0955.

All international enquiries email: export@gme.net.au

Part Number: 311028 Drawing Number: 49381-2